



**This document is brought to you by courtesy of
the National Cycle Archive
In partnership with the
Veteran-Cycle Club**

Please acknowledge the source if you refer to this material.

Find out more about the National Cycle Archive [here](#)



BICYCLES AND ACCESSORIES 1990

TREK



TREK[®] UK

American Bicycle Technology

£1.00

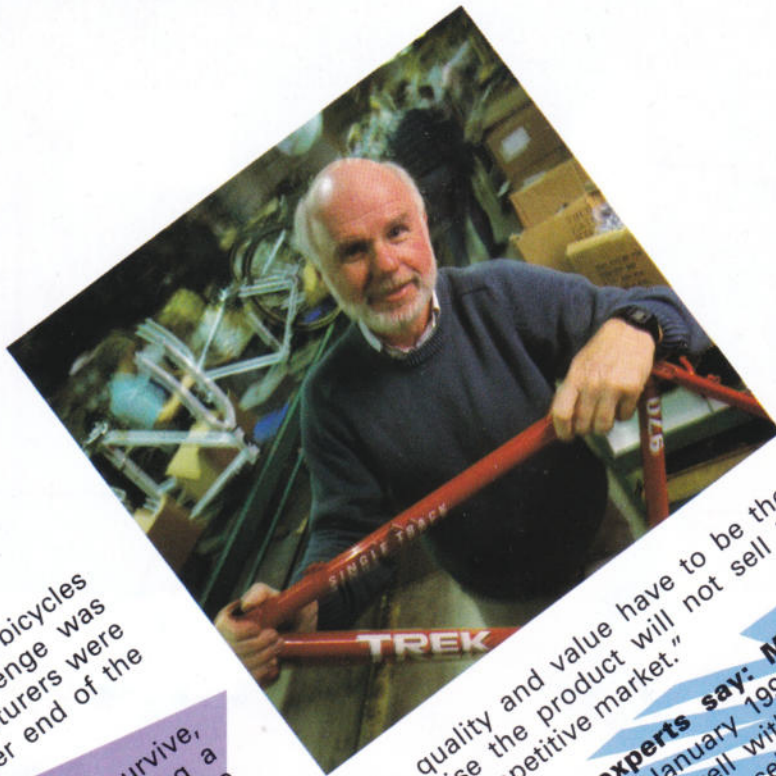

When **TREK** first started building bicycles in 1978, the competitive challenge was staggering. Over 200 manufacturers were offering bicycles in the upper end of the US market.

TREK wanted to do more than survive, and through commitment to building a better product have now become the name that sets the standard for excellence in the industry.

TREK has introduced sophisticated manufacturing techniques, incorporating space age materials in order to provide the finest quality bicycles available throughout the world.

Your riding style, size and performance requirements are just a few of the key considerations used when designing our bicycle.

In 1987, 1988 and 1989 independent subscriber studies conducted by *Bicycling* magazine rated **TREK** as the brand readers were most likely to buy. This level of acceptance comes from providing quality products and exceptional value that best suit the demanding criteria of knowledgeable cycling enthusiasts.

TREK bicycles are now available in the UK. Benefit from **TREK's** dream of building a better bicycle and experience the ride of a truly innovative and technically advanced product.

Satisfying the **TREK** consumer is our top priority. If you have any questions on **TREK** bikes or accessories, please write or phone: **TREK UK**, 15 Old Bridge Way, Shefford, Beds SG17 5HQ. Tel: 0462 811458.

President of **TREK USA**, Dick Burke: "Our objective has always been to produce the best bicycles with quality control, design and customer service being of paramount importance. Consumers are sophisticated

- the quality and value have to be there otherwise the product will not sell in a highly competitive market."

What the experts say: Mountain Biking UK - test January 1990. "TREK's do everything very well without biasing their design toward excellence in any department at the expense of another... TREK are onto a set of winners."

Winning - test January 1990. "TREK bikes, now imported into the UK set new standards of form and function."

TREK TECH All **TREK's** road and mountain bikes are specified and built to demanding standards. Through extensive computer-aided design, **TREK** engineers

CONTENTS

THE ANTELOPE SERIES

THE ALUMINUM ROAD SERIES

THE SINGLE TRACK SERIES

THE ALUMINUM MOUNTAIN SERIES

CLOTHING

ACCESSORIES



Investment cast lugs stiffen the frame and provide a uniquely superior bond. They assure the correct geometry and precise alignment and are bonded to the alloy to avoid any weakening and warping associated with the welding of aluminum.

are able to produce specific castings and tubing dimensions which result in a stiffer, more efficient frame structure.

The geometry of all the frames is function-specific with frame sizes matching the rider's ergonomics. No detail on the specification has been overlooked with special emphasis being placed on comfort zones like saddles and grips.

The Matrix wheel, rim and tyre system has also been carefully developed and race-tested to ensure lightness, strength and durability both in function and finish.

All **TREK's** frames come with a lifetime guarantee. Together with **TREK's** exclusive 28 working day replacement tube service for aluminum models, it makes for the customer's complete piece of mind.



Low temperature brazed investment cast lugs allow for the use of lighter weight True Temper tubing.

FRAME GEOMETRY										
Model	Frame size	A	B	C	D	E	F	G	H	Trail
8500	18	70.0°	73.0°	15.9	21.7	16.9	11.5	1.8	41.4	2.7
	20	71.0°	73.0°	17.4	22.3	16.9	11.6	1.8	41.5	2.6
	22	71.0°	73.0°	19.4	22.6	16.9	11.6	1.8	41.6	2.6
8000	16.5	70.5°	73.0°	15.9	21.7	16.9	11.5	1.8	41.4	2.7
	18	71.0°	73.0°	17.4	22.3	16.9	11.6	1.8	41.5	2.6
	20	71.0°	73.0°	19.4	22.6	16.9	11.6	1.8	41.6	2.6
950	16.5	69.5°	72.5°	15.9	21.7	16.9	11.5	2.0	41.8	2.6
	18	70.0°	72.0°	17.4	22.3	16.9	11.6	2.0	42.0	2.8
	20	70.0°	72.0°	19.4	22.6	16.9	11.6	2.0	42.0	2.8
970	16.5	69.5°	72.5°	15.9	21.7	16.9	11.5	2.0	41.5	2.5
	18	70.0°	72.0°	17.4	22.3	16.9	11.6	2.0	41.5	2.5
	20	70.0°	72.0°	19.4	22.6	16.9	11.6	2.0	42.0	2.8
950	16.5	69.5°	72.5°	15.9	21.7	16.9	11.5	2.0	42.0	2.8
	18	70.0°	72.0°	17.4	22.3	16.9	11.6	2.0	42.0	2.8
	20	70.0°	72.0°	19.4	22.6	16.9	11.6	2.0	42.0	2.8
820	15	69.5°	72.5°	14.4	20.9	17.2	11.6	2.0	42.0	2.6
	18	70.0°	72.0°	17.4	22.3	17.2	11.6	2.0	42.0	2.6
	24	69.5°	72.5°	15.9	21.7	17.2	11.5	2.0	43.0	2.5
800	16.5	70.0°	72.0°	19.4	22.6	17.2	11.6	2.0	42.0	2.6
	18	70.5°	72.0°	19.4	22.6	17.2	11.6	2.0	42.0	2.6
	24	70.5°	72.0°	21.4	23.0	17.2	11.6	2.0	43.0	2.5
800 x 24"	15.5	69.5°	70.0°	14.9	19.3	16.6	11.3	2.0	38.8	2.4
	17	73.5°	73.5°	55.1	55.0	41.5	6.9	4.5	98.6	5.3
	55	73.5°	73.5°	57.0	57.0	41.5	6.9	4.5	100.6	5.3
1400	19	70.5°	73.0°	16.4	21.3	16.9	11.6	1.8	41.0	2.9
	21	71.5°	73.0°	18.4	21.9	16.9	11.6	1.8	40.9	2.7
	23	71.5°	73.0°	20.4	22.2	16.9	11.6	1.8	41.0	2.7
1200	17	69.5°	72.5°	17.0	21.5	17.2	11.5	2.0	42.0	2.8
	19	70.5°	72.0°	19.4	22.6	17.2	11.6	2.0	42.0	2.6
	21	71.5°	73.0°	21.4	23.0	17.2	11.6	2.0	42.0	2.6

All dimensions are in inches, unless otherwise stated

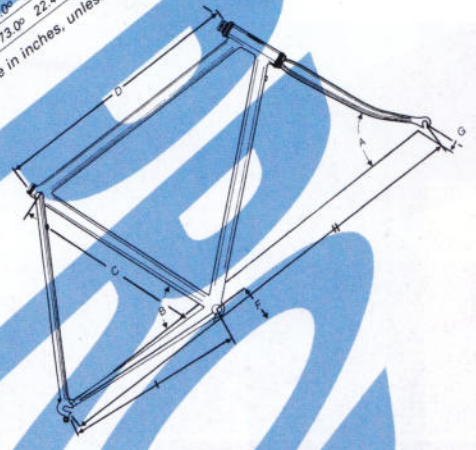

American-made True Temper Chromoly tubing is custom drawn to exacting tolerances.

MODEL 800
rrp £249.95



- **Sizes** 15, 16.5, 18, 20, 22 and 24" men and 17" ladies, 15.5 x 24" wheel.
- **Frame / Forks** ATB Cro-moly main tubes / Hi Tensile Unicrown - forged verticle dropouts.
- **Hubs** Shimano 36 h cassette SF, QR front.
- **Rims** Araya MP-22, 26 x 1.5" alloy.
- **Tyres** Matrix CDX, 26 x 1.5" skinwall knobby.
- **Drive Train** Shimano 200Gs 7 speed Hyperglide indexed / 48-38-28 Biopace Superglide.

- **Freewheel** Shimano Hyperglide 12-28 cassette.
- **Pedals** HTI nylon ATB.
- **Brakeset** Shimano 200GS cantilevers with SLR ATB levers.
- **Stem / Bars** Delta black / 600mm rise bars.
- **Saddle** Viscount padded ATB.
- **Colour** Black with Bright Blue logo. Also available in White with Bright Green logo.

THE ANTELOPE SERIES
 at home on the mountain trail
 or in the city

MODEL 820
rrp £269.95



- **Sizes** 16.5, 18, 20, and 22".
- **Frame / Forks** ATB Cro-moly main tubes / Hi Ten Unicrown - forged verticle dropouts.
- **Hubs** Shimano 36 h cassette SF with QR front.
- **Rims** Araya MP-22, 26 x 1.5" alloy.
- **Tyres** Matrix CDX, 26 x 1.5" skinwall knobby.
- **Drive Train** Shimano 200GS Rapid Fire STI, 7 speed Hyperglide indexed / 48-38-28 Biopace Superglide.

- **Freewheel** Shimano Hyperglide 12-28 cassette.
- **Pedals** HTI nylon ATB.
- **Brakeset** Shimano 200GS cantilevers with SLR ATB levers.
- **Stem / Bars** Delta black / 600mm rise bars.
- **Saddle** Matrix Gel Lycra ATB.
- **Colour** Bright Red with White logo.

MODEL 830

rrp £299.95



Sizes 16.5, 18, 20, and 22" men and 17" ladies.

Frame / Forks ATB Cro-moly main tubes / Cro-moly Unicrown - forged verticle dropouts.

Hubs Shimano 36 h cassette SF QR.

Rims Araya MP-22, 26 x 1.5" alloy.

Tyres Matrix CDX, 26 x 1.5" skinwall knobbly.

Drive Train Shimano Exage 300LX Rapid Fire STI, 7 speed Hyperglide indexed / 48-38-28 Biopace Superglide.

Freewheel Shimano Hyperglide 12-28 cassette.

Pedals HTI nylon ATB.

Brakeset Shimano 300LX cantilevers with SLR ATB levers.

Stem / Bars Cro-moly "T" bone type / HL competition 600mm flat.

Saddle Viscount Ultra padded ATB.

Colour Black with Bright Green logo.

with our lifetime warranty!
a first choice for value

MODEL 850

rrp £349.85



Sizes 16.5, 18, 20, and 22".

Frame / Forks Tange Double Butted Cro-moly throughout / Cro-moly Unicrown - forged verticle dropouts.

Hubs JY sealed ATB 36 hole SF QR.

Rims Araya CP-20, 26 x 1.5" alloy.

Tyres Matrix Single Track AT, 26 x 1.95".

Drive Train Sountour XCE 7 speed Express Accushift Plus Indexing / Sr X1 48-38-28 black AJS.

Freewheel Sountour Accushift Plus 13-30 7 speed.

Pedals HTI nylon ATB.

Brakeset Dia Compe XCE cantilevers with DC BRS ATB levers.

Stem / Bars Cro-moly "T" bone type / Competition 600mm flat.

Saddle Matrix Gel Lycra ATB.

Colour Intense Blue with White logo.

What the experts say: Mountain Biking UK - test January 1990. "The 850 represents extremely good value for

money, sporting a well-constructed frame and dependable equipment for the entry level price of £350."

All TREK's aluminum road bikes conform to international race regulations

THE ALUMINUM ROAD SERIES

carefully engineered to give a stiff responsive ride without sacrificing comfort



TREK

THE MULTI-TRACK 750
blends the strength and durability
of a performance mountain bike
with the speed and comfort of a
road bike

MODEL 750
rrp £449.95



Sizes 17, 19, 21 and 23".

Frame / Forks True Temper AT double butted Cro-moly / Cro-moly unicrown Multi-track also featuring a Trek Investment cast seat lug.

Hubs Sansin 32h SF QR.

Rims Matrix Titan II, hard anodised with 15G stainless steel spokes.

Tyres Matrix Multi-track 700 x 35c.

Drive Train Suntour XCM, 7 speed, X-press Accushift Indexing / SR XCM 48-38-28 round BRS chainset.

Freewheel Suntour Accushift Plus 13-30.

Pedals MKS nylon ATB with toe clips and straps.

Brakeset Dia Compe XCM cantilevers with BRS ATB levers.

Stem / Bars Delta alloy forged / True Temper Cro-moly 520mm.

Saddle / Seat Pin Vetta Gel Lycra / Alloy micro adjust.

Colour Black with Bright Green logo.

MODEL 1200

rrp £529.95



Sizes 47, 50, 52, 54, 56, 58, 60, and 62cm.

Frame / Forks Easton 6061 TG Aluminum Alloy / Cro-moly Aero sloping crown.

Hubs Shimano RX100, 32 h cassette SF QR.

Rims Matrix ISO - CII hard anodised with 15G stainless steel spokes.

Tyres Matrix CD-3 700 x 25c pressures.

Drive Train Shimano RX100, 7 speed hyperglide Indexing / 53-42 Superglide round chainset.

Freewheel Shimano Hyperglide 13-23 cassette.

Pedals RX 100 with clips and straps.

Brakeset Shimano RX100 Dual Pivot callipers with Aero SLR levers.

Stem / Bars Alloy forged / SR Modolo Contour.

Saddle / Seat Pin Vetta Gel Turbo Lycra / Alloy micro adjust.

Colour White with Purple logo.

What the experts say: Winning - test January 1990. "Both frames were perfectly stable, with neutral steering and a vibration free ride."

MODEL 1400

rrp £629.95



Sizes 47, 50, 52, 54, 56, 58, 60, and 62cm.

Frame / Forks Easton E9 Double Butted Aluminum Alloy / Trek Bonded Aluminum with stainless steel ends.

Hubs Shimano 105, 32 h cassette SF QR.

Rims Matrix ISO - CII hard anodised with 15G stainless steel spokes.

Tyres Matrix CD-3 700 x 25c high pressure.

Drive Train Shimano 105 7 speed hyperglide Indexing / 53-42 Superglide round chainset.

Freewheel Shimano Hyperglide 13-23 cassette.

Pedals Look 66 adjustable clipless.

Brakeset Shimano 105 Dual Pivot callipers with Aero SLR levers.

Stem / Bars Alloy forged / SR Modolo Contour.

Saddle / Seat Pin Vetta Gel Turbo Lycra / Alloy micro adjust.

Colour Intense Blue with White logo.

MODEL 930
rrp £449.95



Sizes 16.5, 18, 20, and 22".

Frame / Forks True Temper AT Double Butted Cro-moly / Tange taper gauge unicrown - forged verticle drop outs, featuring a Trek investment cast seat lug.

Hubs Sansin 32h SF QR.

Rims Matrix Single Track, 26 x 1.5" hard anodised with 14G stainless steel spokes.

Tyres Matrix Single Track AT, 26 x 1.95".

Drive Train Suntour X1 7 speed X-press Accushift Plus indexing / SR 48-38-28 round AJS.

Freewheel Suntour Accushift Plus 13-30 7 speed.

Pedals MKS nylon ATB with toe clip and strap.

Brakeset Dia Compe X-1 cantilever with DC short stop BRS levers.

Stem / Bars Cro-moly "T" bone type / True Temper competition Cro-moly.

Saddle / Seat Pin Vetta Gel Lycra ATB / Micro adjust alloy 300mm.

Colour Black with Bright Blue logo.

THE SINGLE TRACK SERIES
TREK investment cast lugs, True Temper tubing and

MODEL 950
rrp £499.95



Sizes 16.5, 18, 20, and 22".

Frame / Forks True Temper AT Double Butted Cro-moly / Trek Cruise Control taper gauge Cro-moly with forged verticle dropouts featuring a Trek Investment cast seat lug.

Hubs Shimano Deore LX, 32h cassette SF QR.

Rims Matrix Single Track, 26 x 1.5" hard anodised with 14G stainless steel spokes.

Tyres Matrix Single Track AT, 26 x 1.95".

Drive Train Shimano Deore LX Rapid Fire, 7 speed indexing / 46-36-24 Superglide round.

Freewheel Shimano Hyperglide 12-30 cassette.

Pedals MKS nylon ATB with toe clips and straps.

Brakeset Shimano Deore LX cantilevers with SLR ATB levers.

Stem / Bars Cro-moly "T" bone type / True Temper competition Cro-moly.

Saddle / Seat Pin Vetta Gel Lycra ATB / Micro adjust alloy.

Colour White with Black logo. Also available in Blue with White logo.

MODEL 970
rrp £629.95



Sizes 16.5, 18, 20, and 22".

Frame / Forks True Temper AT Double Butted Cro-moly / Trek Cruise Control taper gauge Cro-moly with forged verticle dropouts featuring a Trek Investment cast seat lug.

Hubs Shimano Deore DX, 32h cassette SF QR.

Rims Matrix Single Track Comp, 26 x 1.5" hard anodised with 14G stainless spokes.

Tyres Matrix Single Track AT, 26 x 1.95".

Drive Train Shimano Deore DX Rapid Fire, 7 speed indexing / 46-36-24 Superglide round.

Freewheel Shimano Hyperglide 13-30 cassette.

Pedals Shimano Deore DX with toe clips and straps.

Brakeset Shimano Deore DX cantilevers with SLR two-finger levers featuring Triple Tech cable routing.

Stem / Bars Tioga "T" bone / True Temper competition Cro-moly.

Saddle / Seat Pin Vetta Gel Lycra ATB / Matrix bonded, heat treated cro-moly and alloy.

Colour Bright Red with White logo.

a Matrix 32-spoke wheel package
 a lighter, stronger machine simply add up to

MODEL 990
rrp £849.95



Sizes 16.5, 18, 20, and 22".

Frame / Forks True Temper ATX heat treated ATB Cro-moly / Tange Big Fork with forged verticle dropouts, featuring a Trek Investment cast seat lug.

Hubs Shimano Deore XT, 32h cassette SF QR.

Rims Matrix Mt AERO ATB, hard anodised with 14G stainless spokes.

Tyres Matrix Single Track AT, 26 x 1.95".

Drive Train Shimano Deore DX Rapid Fire, 7 speed indexing / 46-36-24 Superglide round.

Freewheel Shimano Hyperglide 13-28 cassette.

Pedals Shimano Deore XT with toe clips and straps.

Brakeset Shimano Deore XT cantilevers with SLR two-finger levers featuring Triple Tech cable routing.

Stem / Bars Tioga "T" bone / Matrix - Easton alloy Taper Lite.

Saddle / Seat Pin Vetta Gel Turbo Lycra ATB / Matrix bonded, heat treated cro-moly and alloy.

Colour Black/White splash with White logo.

THE ALUMINUM

it's light and agile, a great all round mountain bike, and, at under £600 it would make a good value first race bike."

MODEL 7000
rrp £599.95



What the experts say: Mountain Biking UK - test January 1990. "We were very impressed with the ride of the 7000;

Sizes 16.5, 18, 20, and 22".

Frame / Forks Easton 6061 E9 double butted aluminum alloy / Trek Cruise Control taper gauge Cro-moly with TIG welded uncrown.

Hubs Shimano Deore LX, 32h cassette SF QR.

Rims Matrix Single Track hard anodised with 14G stainless steel spokes.

Tyres Matrix Single Track AT, 26 x 1.95".

Drive Train Shimano Deore LX Rapid Fire, 7 speed indexing / 46-36-24 Superglide round.

Freewheel Shimano Hyperglide 13-30 cassette.

Pedals MKS nylon ATB with toe clips and straps.

Brakeset Shimano Deore LX cantilevers with SLR ATB levers.

Stem / Bars Cro-moly "T" bone type / True Temper competition Cro-moly.

Saddle / Seat Pin Vetta Gel Lycra ATB / Matrix adjust alloy.

Colour Black with White splash with Bright Green logo. Also available in White with Bright Green.

are aerospace bonded to TREK's unique internal lugs and 21 percent lighter than conventional cro-moly 17 percent stiffer

MODEL 8000
rrp £729.95



Sizes 16.5, 18, 20, and 22".

Frame / Forks Trek/Easton 7000 E9 double butted aluminum alloy / Tange Big Fork with cast tips and TIG welded uncrown.

Hubs Shimano Deore DX, 32h cassette SF QR.

Rims Matrix Mt Aero, hard anodised with 14G stainless spokes.

Tyres Matrix Single Track AT, 26 x 2.0".

Drive Train Shimano Deore DX Rapid Fire, 7 speed indexing / 46-36-24 Superglide round.

Freewheel Shimano Hyperglide 13-30 cassette.

Pedals Shimano Deore DX with toe clips and straps.

Brakeset Shimano Deore DX cantilevers with SLR two-finger levers featuring concealed rear cable routing.

Stem / Bars Tioga "T" bone / True Temper competition Cro-moly.

Saddle / Seat Pin Vetta Gel Lycra ATB / Matrix bonded.

Colour White with Black splash with Bright Blue logo. Also available in Red with White logo.

MOUNTAIN SERIES

MODEL 8500
rrp £949.95



Sizes 16.5, 18, 20, and 22".

Frame / Forks Trek/Easton 7000 E9 double butted aluminum alloy / Tange Big Fork with cast tips and TIG welded unicrown.

Hubs Shimano Deore XT, 32h cassette SF QR.

Rims Matrix Mt Aero ATB, hard anodised with 14G stainless spokes.

Tyres Matrix Single Track AT, 26 x 2.0".

Drive Train Shimano Deore XT Rapid Fire, 7 speed indexing / 46-36-24 Superglide round.

Freewheel Shimano Hyperglide 13-28 cassette.

Pedals Shimano Deore XT with toe clips and straps.

Brakeset Shimano Deore XT cantilevers with SLR two-finger levers featuring concealed rear cable routing.

Stem / Bars Tioga "T" bone / Matrix - Easton alloy Taper Lite.

Saddle / Seat Pin Vetta Gel Turbo Lycra ATB / Matrix bonded, heat treated cro-moly and alloy.

Colour Black with White splash with White logo.

THE CARBON FIBRE 8900 will do more than
 win bike races - it will win your heart
 state of
 the art

MODEL 8900
rrp £1999.95



Sizes 16.5, 18, 20, and 22".

Frame / Forks Graphite Epoxy / Tange Big Fork.

Hubs Bullseye precision 32h SF QR.

Rims Matrix Mt Aero ATB, hard anodised with 14G stainless spokes.

Tyres Matrix Single Track Comp, KL Kevlar folding.

Drive Train Suntour XC Pro Accushift Plus X-press indexing / Matrix by G Cook black alloy 48/36/24 round ALS rings.

Freewheel Suntour New Winner Pro, 12-28.

Pedals Suntour XC Pro competition alloy with clips and straps.

Brakeset Grafton speed control cantilevers with Aztec pads, XC Pro comp levers.

Stem / Bars AMB TIG welded alloy / Matrix - Easton alloy Taper Lite.

Saddle / Seat Pin Sella Italia Turbo / Matrix bonded, heat treated cro-moly and alloy.

Colour Green, Yellow and Black.

TREK GORE-TEX RAIN SUITE JACKET rrp £169.95



This top passes W.L. Gore's stringent outerwear test: "Gore performance Standard 2 - for Wet Weather", their highest standard. Longer sleeves, pull down rear flap, front air vents, zip pockets and velcro cuffs make the ultimate jacket.

Jacket colour Black / Purple
Sizes SM, MD, LG, XL.

BOPPIN BIKE SHORTS rrp £29.95



poly-Lycra inner short with fleece pad and a stylish Nylon



BOOGIE BIKE SHORTS rrp £24.95

LONG SLEEVE T-SHIRT rrp £15.95
SHORT SLEEVE T-SHIRT rrp £12.95



100% US-made cotton. **Colours** White, Yellow, Black, Blue.
Also available in various colours.

A-TRAINER SHORT rrp £29.95

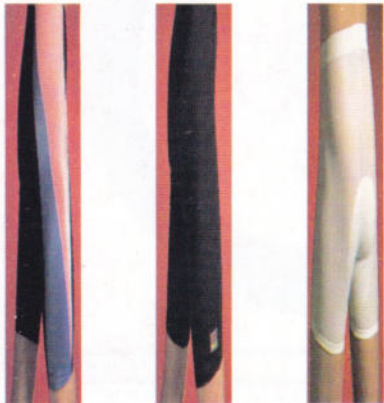

BOOGIE SHORT LINER rrp £9.95

Boogie inner liner provides riding comfort under any short.

Anatomically cut six panel short featuring Micro-Suede pad with Coolmax front, Soft-Grip leg bands and adjustable waist.

Sizes Women's - SM, MD, LG.

Sizes Men's - SM/MD, LG, XL.

Colours Women's - Black with Melon.

Colours Men's - Black Zio-Zag. Black with Logo.



COTTON RACING CAP rrp £4.95 Available in various colours.



A full function riding short. As Boogie plus two front pockets and an adjustable waist band.
Sizes Men's - as Boogie. **Sizes Women's** - as Boogie.
Colours Men's - Fantasy Pink with Lime
Colours Women's - Fantasy Navy, Fluorescent Yellow + logo.

outer with velcro close rear pocket. **Sizes Women's** - XS, SM, MD, LG. **Sizes Men's** - SM, MD, LG, XL.



Extra cool 100% cotton jersey for all day comfort. Zip neck, reinforced rear pockets.
Sizes Women's - SM, MD, LG. **Sizes Men's** - SM/MD, LG, XL.
Colours Women's - Melon, Lilac and White.
Colours Men's - White with logo, Neon Lime, Multicolour



COTTON CLUB JERSEY rrp £29.95



HT1 BUM BAG rrp £9.95

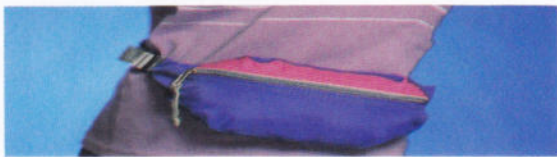

HT2 BUM BAG rrp £12.95



SEAT PACK SPX rrp £14.95



HT1 BUM BAG

Constructed of lightweight pack cloth with two zip compartments and Fastex buckle closure. 150cu.in" capacity.

Colours Turquoise / Black
Black - Lime - Pink

HT2 BUM BAG

Same quality construction and design as HT1 but with extra capacity of 275cu.in"

Colours Turquoise / Black
Cobolt / Black.

SEAT PACK SPX

70cu.in" cordura pack with zipped extension pocket to increase capacity to 130cu.in".

Colours Black, Red / Blue
Black, Lime,
Pink.



MATRIX HELMETS

are not an accessory, they're a necessity. The most critical factor in any helmet design is its ability to provide maximum protection. The three Matrix helmets all meet or exceed the Ansi Z90 and Snell 84 standards for bicycle helmets and all weigh in at eight ounces or less. Advanced venting systems include large vents with airflow channels to keep your head cool in the warmest conditions.

Matrix Lite single density foam with Nylon Lycra cover, rrp £29.95 (not shown).

Matrix Ultra-lite dual density foam with Nylon Lycra cover, rrp £39.95 (pictured above).

Matrix Micro-lite dual density foam with hard shell plastic outer, rrp £59.95 (not shown).
Sizes **XS, SM, MD, LG.**



Race shoe



ATB boot



ATB 500 shoe

Model 500 ATB shoe rrp £39.95

An all purpose shoes suitable for all aspects of off or on road riding. Sturdy heel counter decreases lateral movement and dual density midsole provides optimum rider comfort. Colour as shown.
Sizes **39 to 46** metric.

Model 600 ATB boot rrp £44.95

A versatile and durable shoe for all off road conditions. Special dual density sole is designed for optimum pedal grip and walking in muddy conditions. Colour as shown.
Sizes **39 to 46** metric.

Model 900 Race shoe rrp £59.95

A race, performance shoe for the serious competitor. Lightweight, cool, non stretch upper and ventilated ACCUJUST sole makes the 900 a design and quality leader. Colour as shown.
Sizes **39 to 46** metric.



TITAN 2 ROAD

Super finish hard coat anodising. Good shock absorption and lateral strength. **390 grams, 700c x 36h, 700c x 32h, rrp £34.95 pair**

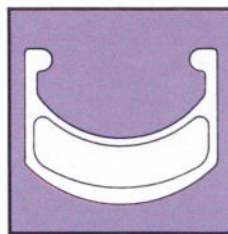

TITAN TOUR ROAD

Tall, flat sidewalls allow for best braking performance. Easy mounting for large section touring tyres. **425 grams, 700c x 36h, 27" x 36h, rrp £34.95 pair**



ISO - C2 ROAD

Improved braking surface and comfort. Hard anodised finish and better torsion rigidity. **325 grams, 700c x 36h, 700c x 32h, rrp £39.95 pair.**

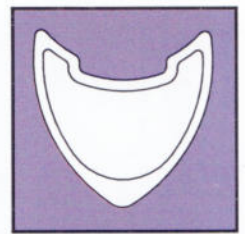

ISO 2 ROAD

Tubular rim with special well design allowing for easier mounting and better adhesion. Heat treated and hard anodised finish. **375 grams, 32h, 28h, rrp £39.95 pair**



SINGLE TRACK ATB

Tall profile sheds mud and provides better braking surface. Hard coat anodised. **500 grams, 26" x 36h, 26" x 32h, rrp £34.95 pair**

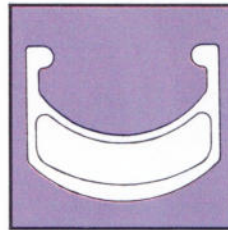

SINGLE TRACK C ATB

Offset hole drilling designed to angle nipples toward hub flanges to improve fatigue life of the spoke. Hard anodised finish. **450 grams, 26" x 36h, 26" x 32h, rrp £39.95 pair.**

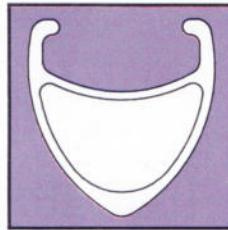

Mt AERO ATB

This 26" ATB version of the ISO-C 2 is a unique narrow aero ATB rim. Provides improved radial rigidity and sheds mud! **350 grams, 26" x 36h, 26" x 32h, rrp £44.95 pair.**



Mt TITAN ATB

Amazingly light mountain bike rim. Hard anodised finish. The ultimate race rim. **345 grams, 26" x 36h, 26" x 32h, rrp £49.95.**



MATRIX ATB TYRES

SINGLE TRACK AT best-selling ATB tyre, **825g/35-70psi**. Size **26x2.0**, rrp **£12.95**. **SINGLE TRACK COMP** with low rolling resistance, **800g/45-80psi**. Size **26x1.95**, rrp **£14.95**. **SINGLE TRACK COMP L** with folding Kevlar bead, **800g/45-80psi**. Size **27x1 1/4**, **700x25c**, rrp **£12.95**. **CD5** with folding Kevlar bead for better performance, **195g/125psi**. Sizes **700x20c**, **700x25c**, rrp **£14.95**. **CD5K** with puncture resistant Kevlar belt, **205g/125psi**. Sizes **700x25c**, **700x20c**, rrp **£19.95**.

MATRIX ROAD TYRES

CDI economical quality replacement tyre, **275g/100psi**. Size **27x1**, **700x28c**, **27x1 1/4**, rrp **£7.49**. **CD3** popular performance tyre, **225g/100psi**. Sizes **27x1 1/4**, **700x25c**, rrp **£9.95**. **CD3K** with Kevlar belt for increased durability and puncture resistance **235g/100psi**. Sizes **27x1 1/4**, **700x25c**, rrp **£12.95**. **CD5** with folding Kevlar bead for better performance, **195g/125psi**. Sizes **700x20c**, **700x25c**, rrp **£14.95**. **CD5K** with puncture resistant Kevlar belt, **205g/125psi**. Sizes **700x25c**, **700x20c**, rrp **£19.95**.

A full range of complimentary quality Matrix tubes are also available.

WARRANTY TREK BICYCLE CORPORATION LIMITED ("TREK") warrants to any customer purchasing a **TREK** bicycle that the bicycle frame and fork will be free from defects in workmanship and materials for as long as the customer owns the bicycle and that all other original parts will be free from defects in workmanship and materials for a period of one year from the date of purchase. If a frame, fork or original part is found to be defective, **TREK** will repair or replace the defective item, as it thinks fit.

This warranty does not apply to normal wear and tear nor to defects arising out of any accident, incorrect handling or abnormal use, disregard of instructions, neglect, improper assembly or maintenance, or the fitting of non-original parts.

Claims under this warranty should be made through an authorised **TREK** dealer. Proof of purchase will be required.

THIS WARRANTY DOES NOT AFFECT THE STATUTORY RIGHTS OF A CUSTOMER

