

# The welding of aluminium and its alloys

---

Gene Mathers



**CRC Press**  
**Boca Raton Boston New York Washington, DC**

**WOODHEAD PUBLISHING LIMITED**  

---

**Cambridge England**

Published by Woodhead Publishing Limited, Abington Hall, Abington  
Cambridge CB1 6AH, England  
www.woodhead-publishing.com

Published in North America by CRC Press LLC, 2000 Corporate Blvd, NW  
Boca Raton FL 33431, USA

First published 2002, Woodhead Publishing Ltd and CRC Press LLC

© 2002, Woodhead Publishing Ltd  
The author has asserted his moral rights.

This book contains information obtained from authentic and highly regarded sources. Reprinted material is quoted with permission, and sources are indicated. Reasonable efforts have been made to publish reliable data and information, but the author and the publishers cannot assume responsibility for the validity of all materials. Neither the author nor the publishers, nor anyone else associated with this publication, shall be liable for any loss, damage or liability directly or indirectly caused or alleged to be caused by this book.

Neither this book nor any part may be reproduced or transmitted in any form or by any means, electronic or mechanical, including photocopying, microfilming and recording, or by any information storage or retrieval system, without permission in writing from the publishers.

The consent of Woodhead Publishing and CRC Press does not extend to copying for general distribution, for promotion, for creating new works, or for resale. Specific permission must be obtained in writing from Woodhead Publishing or CRC Press for such copying.

Trademark notice: Product or corporate names may be trademarks or registered trademarks, and are used only for identification and explanation, without intent to infringe.

British Library Cataloguing in Publication Data  
A catalogue record for this book is available from the British Library.

Library of Congress Cataloging in Publication Data  
A catalog record for this book is available from the Library of Congress.

Woodhead Publishing ISBN 1 85573 567 9  
CRC Press ISBN 0-8493-1551-4  
CRC Press order number: WP1551

Typeset by SNP Best-set Typesetter Ltd., Hong Kong  
Printed by TJ International, Padstow, Cornwall, England

Engineering is not an exact science and, of the many disciplines within engineering, welding is probably one of the most inexact – rather more of an art than a science. Much of the decision-making is based on experience and a ‘gut feel’ for what is or is not acceptable. When the difficulties of shop floor or site control are taken into account and the occasional vagaries of the welder and the sometimes inadequate knowledge of supervisory staff are added, the problems of the practising shop floor engineer can appear overwhelming. I hope that some of this uncertainty can be dispelled in this book, which is aimed at those engineers with little or no knowledge of metallurgy and perhaps only the briefest acquaintance with the welding processes. It does not purport to be a metallurgical or processes textbook and I make no apology for this. Having lectured fairly extensively on welding technology, I have come to realise that most engineers think of metals as being composed of a large number of small billiard balls held together by some form of glue. I have attempted to describe the metallurgical aspects of the aluminium alloys in these terms. I have therefore kept the contents descriptive and qualitative and have avoided the use of mathematical expressions to describe the effects of welding.

The book provides a basic understanding of the metallurgical principles involved in how alloys achieve their strength and how welding can affect these properties. I have included sections on parent metal storage and preparation prior to welding and have also described the more frequently encountered processes. There are recommendations on welding parameters that may be used as a starting point for the development of a viable welding procedure. Also included are what I hope will be useful hints and tips to avoid some of the pitfalls of welding these sometimes problematic materials.

I would like to thank my colleagues at TWI, particularly Bob Spiller, Derek Patten and Mike Gittos, for their help and encouragement during the writing of this book – encouragement that mostly took the form of ‘Haven’t you finished it yet?’. Well, here it is. Any errors, inaccuracies or omissions are mine and mine alone.

*Gene Mathers*

# Contents

---

	<i>Preface</i>	ix
<b>1</b>	<b>Introduction to the welding of aluminium</b>	<b>1</b>
1.1	Introduction	1
1.2	Characteristics of aluminium	4
1.3	Product forms	6
1.4	Welding: a few definitions	6
<b>2</b>	<b>Welding metallurgy</b>	<b>10</b>
2.1	Introduction	10
2.2	Strengthening mechanisms	10
2.3	Aluminium weldability problems	18
2.4	Strength loss due to welding	31
<b>3</b>	<b>Material standards, designations and alloys</b>	<b>35</b>
3.1	Designation criteria	35
3.2	Alloying elements	35
3.3	CEN designation system	36
3.4	Specific alloy metallurgy	40
3.5	Filler metal selection	46
<b>4</b>	<b>Preparation for welding</b>	<b>51</b>
4.1	Introduction	51
4.2	Storage and handling	51
4.3	Plasma-arc cutting	52
4.4	Laser beam cutting	58
4.5	Water jet cutting	63
4.6	Mechanical cutting	64
4.7	Cleaning and degreasing	66

<b>5</b>	<b>Welding design</b>	<b>69</b>
5.1	Introduction	69
5.2	Access for welding	70
5.3	Welding speed	71
5.4	Welding position	72
5.5	Edge preparation and joint design	72
5.6	Distortion	84
5.7	Rectification of distortion	88
5.8	Fatigue strength of welded joints	89
<b>6</b>	<b>TIG welding</b>	<b>97</b>
6.1	Introduction	97
6.2	Process principles	97
6.3	Mechanised/automatic welding	114
6.4	TIG spot and plug welding	115
<b>7</b>	<b>MIG welding</b>	<b>116</b>
7.1	Introduction	116
7.2	Process principles	116
7.3	Welding consumables	130
7.4	Welding procedures and techniques	135
7.5	Mechanised and robotic welding	141
7.6	Mechanised electro-gas welding	143
7.7	MIG spot welding	144
<b>8</b>	<b>Other welding processes</b>	<b>147</b>
8.1	Introduction	147
8.2	Plasma-arc welding	147
8.3	Laser welding	150
8.4	Electron beam welding	155
8.5	Friction welding	160
<b>9</b>	<b>Resistance welding processes</b>	<b>166</b>
9.1	Introduction	166
9.2	Power sources	167
9.3	Surface condition and preparation	169
9.4	Spot welding	171
9.5	Seam welding	175
9.6	Flash butt welding	176

<b>10</b>	<b>Welding procedure and welder approval</b>	<b>181</b>
10.1	Introduction	181
10.2	Welding procedures	181
10.3	Welder approval	191
<b>11</b>	<b>Weld defects and quality control</b>	<b>199</b>
11.1	Introduction	199
11.2	Defects in arc welding	199
11.3	Non-destructive testing methods	205
	<i>Appendix A British and ISO standards related to welding and aluminium</i>	216
	<i>Appendix B Physical, mechanical and chemical properties at 20°C</i>	226
	<i>Appendix C Principal alloy designations: cast products</i>	227
	<i>Appendix D Alloy designations: wrought products</i>	228
	<i>Bibliography</i>	230
	<i>Index</i>	235

## 1.1 Introduction

The existence of aluminium (Al) was postulated by Sir Humphrey Davy in the first decade of the nineteenth century and the metal was isolated in 1825 by Hans Christian Oersted. It remained as somewhat of a laboratory curiosity for the next 30 years when some limited commercial production began, but it was not until 1886 that the extraction of aluminium from its ore, bauxite, became a truly viable industrial process. The method of extraction was invented simultaneously by Paul Heroult in France and Charles M. Hall in the USA and this basic process is still in use today. Because of its reactive nature aluminium is not found in the metallic state in nature but is present in the earth's crust in the form of different compounds, of which there are several hundreds. The most important and prolific is bauxite. The extraction process consists of two separate stages, the first being the separation of aluminium oxide,  $\text{Al}_2\text{O}_3$  (alumina), from the ore, the second the electrolytic reduction of the alumina at between  $950^\circ\text{C}$  to  $1000^\circ\text{C}$  in cryolite ( $\text{Na}_3\text{AlF}_6$ ). This gives an aluminium, containing some 5–10% of impurities such as silicon (Si) and iron (Fe), which is then refined either by a further electrolytic process or by a zone-melting technique to give a metal with a purity approaching 99.9%. At the close of the twentieth century a large proportion of aluminium was obtained from recovered and remelted waste and scrap, this source alone supplying almost 2 million tonnes of aluminium alloys per annum in Europe (including the UK) alone. The resulting pure metal is relatively weak and as such is rarely used, particularly in constructional applications. To increase mechanical strength, the pure aluminium is generally *alloyed* with metals such as copper (Cu), manganese (Mn), magnesium (Mg), silicon (Si) and zinc (Zn).

One of the first alloys to be produced was aluminium–copper. It was around 1910 that the phenomenon of age or precipitation hardening in this family of alloys was discovered, with many of these early age-hardening

alloys finding a ready use in the fledgling aeronautical industry. Since that time a large range of alloys has been developed with strengths which can match that of good quality carbon steel but at a third of the weight. A major impetus to the development of aluminium alloys was provided by the two World Wars, particularly the Second World War when aluminium became *the* metal in aircraft structural members and skins. It was also in this period that a major advance in the fabrication of aluminium and its alloys came about with the development of the inert gas shielded welding processes of MIG (metal inert gas) and TIG (tungsten inert gas). This enabled high-strength welds to be made by arc welding processes without the need for aggressive fluxes. After the end of the Second World War, however, there existed an industry that had gross over-capacity and that was searching for fresh markets into which its products could be sold. There was a need for cheap, affordable housing, resulting in the production of the 'prefab', a prefabricated aluminium bungalow made from the reprocessed remains of military aircraft – not quite swords into ploughshares but a close approximation! At the same time domestic utensils, road vehicles, ships and structural components were all incorporating aluminium alloys in increasing amounts.

Western Europe produces over 3 million tonnes of primary aluminium (from ore) and almost 2 million tonnes of secondary or recycled aluminium per year. It also imports around 2 million tonnes of aluminium annually, resulting in a per capita consumption of approximately 17 kg per year. Aluminium now accounts for around 80% of the weight of a typical civilian aircraft (Fig. 1.1) and 40% of the weight of certain private cars. If production figures remain constant the European automotive industry is expected to be consuming some 2 million tonnes of aluminium annually by the year 2005. It is used extensively in bulk carrier and container ship superstructures and for both hulls and superstructures in smaller craft (Fig. 1.2). The new class of high-speed ferries utilises aluminium alloys for both the super-structure and the hull. It is found in railway rolling stock, roadside furniture, pipelines and pressure vessels, buildings, civil and military bridging and in the packaging industry where over 400 000 tonnes per annum is used as foil. One use that seems difficult to rationalise in view of the general perception of aluminium as a relatively weak and soft metal is its use in armoured vehicles (Fig. 1.3) in both the hull and turret where a combination of light weight and ballistic performance makes it the ideal material for fast reconnaissance vehicles.

This wide range of uses gives some indication of the extensive number of alloys now available to the designer. It also gives an indication of the difficulties facing the welding engineer. With the ever-increasing sophistication of processes, materials and specifications the welding engineer must have a broad, comprehensive knowledge of metallurgy and welding





1.1 BAC 146 in flight. Courtesy of TWI Ltd.

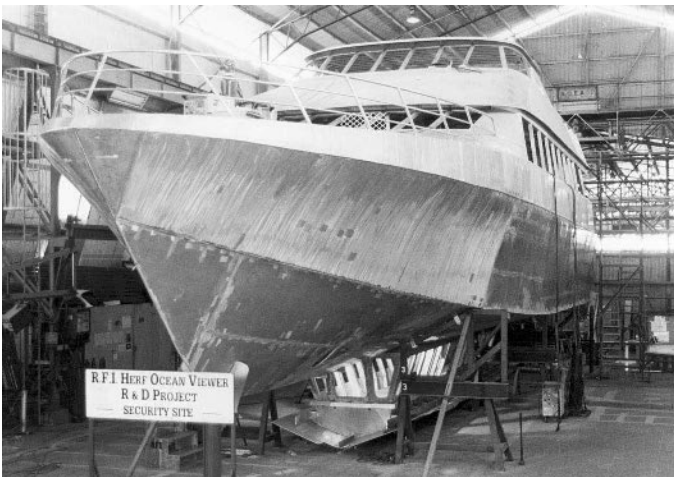

1.2 A Richardson and Associates (Australia) *Ocean Viewer* all-aluminium vessel. The hull is 5mm thick A5083. Courtesy TWI Ltd.



1.3 Warrior armoured fighting vehicle (AFV) utilising Al-Zn-Mg alloys.  
Courtesy of Alvis Vehicles.

processes. It is hoped that this book will go some way towards giving the practising shop-floor engineer an appreciation of the problems of welding the aluminium alloys and guidance on how these problems may be overcome. Although it is not intended to be a metallurgical textbook, some metallurgical theory is included to give an appreciation of the underlying mechanisms of, for instance, strengthening and cracking.

## 1.2 Characteristics of aluminium

Listed below are the main physical and chemical characteristics of aluminium, contrasted with those of steel, the metal with which the bulk of engineers are more familiar. As can be seen from this list there are a number of important differences between aluminium and steel which influence the welding behaviour:

- The difference in melting points of the two metals and their oxides. The oxides of iron all melt close to or below the melting point of the metal; aluminium oxide melts at  $2060^{\circ}\text{C}$ , some  $1400^{\circ}\text{C}$  above the melting point of aluminium. This has important implications for the welding process, as will be discussed later, since it is essential to remove and disperse this oxide film before and during welding in order to achieve the required weld quality.

- The oxide film on aluminium is durable, highly tenacious and self-healing. This gives the aluminium alloys excellent corrosion resistance, enabling them to be used in exposed applications without additional protection. This corrosion resistance can be improved further by *anodising* – the formation of an oxide film of a controlled thickness.
- The coefficient of thermal expansion of aluminium is approximately twice that of steel which can mean unacceptable buckling and distortion during welding.
- The coefficient of thermal conductivity of aluminium is six times that of steel. The result of this is that the heat source for welding aluminium needs to be far more intense and concentrated than that for steel. This is particularly so for thick sections, where the fusion welding processes can produce lack of fusion defects if heat is lost too rapidly.
- The specific heat of aluminium – the amount of heat required to raise the temperature of a substance – is twice that of steel.
- Aluminium has high electrical conductivity, only three-quarters that of copper but six times that of steel. This is a disadvantage when resistance spot welding where the heat for welding must be produced by electrical resistance.
- Aluminium does not change colour as its temperature rises, unlike steel. This can make it difficult for the welder to judge when melting is about to occur, making it imperative that adequate retraining of the welder takes place when converting from steel to aluminium welding.
- Aluminium is non-magnetic which means that arc blow is eliminated as a welding problem.
- Aluminium has a modulus of elasticity three times that of steel which means that it deflects three times as much as steel under load but can absorb more energy on impact loading.
- The fact that aluminium has a face-centred cubic crystal structure (see Fig. 2.2) means that it does not suffer from a loss of notch toughness as the temperature is reduced. In fact, some of the alloys show an improvement in tensile strength and ductility as the temperature falls, EW-5083 (Al Mg 4.5 Mn) for instance showing a 60% increase in elongation after being in service at  $-200^{\circ}\text{C}$  for a period of time. This crystal structure also means that formability is very good, enabling products to be produced by such means as extrusion, deep drawing and high energy rate forming.
- Aluminium does not change its crystal structure on heating and cooling, unlike steel which undergoes crystal transformations or *phase changes* at specific temperatures. This makes it possible to harden steel by rapid cooling but changes in the cooling rate have little or no effect on the aluminium alloys (but see precipitation hardening p 16–17).

### 1.3 Product forms

Aluminium is available in both wrought and cast forms. The wrought forms comprise hot and cold rolled sheet, plate, rod, wire and foil. The ductility and workability of aluminium mean that extrusion is a simple method of producing complex shapes, particularly for long, structural members such as I and H beams, angles, channels, T-sections, pipes and tubes. Forging, both hot and cold, is used extensively as a fast, economical method of producing simple shapes. Precision forging is particularly suitable for aluminium alloys, giving advantages of good surface finish, close tolerances, optimum grain flow and the elimination of machining.

The four most commonly used methods of casting are sand casting, lost wax casting, permanent steel mould casting and die-casting. The requirement for high fluidity in a casting alloy means that many are based on aluminium–silicon alloys although heat-treatable (age-hardening) alloys are often used for sand, lost wax and permanent mould castings. Lost wax and die-casting give products with smooth surfaces to close tolerances and are processes used extensively for aerospace products. A number of alloys, their product forms and applications are listed in Table 1.1.

### 1.4 Welding: a few definitions

Before dealing with the problems of welding aluminium alloys there are a few definitions required, not least of which is welding itself. Welding can be described as the joining of two components by a coalescence of the surfaces in contact with each other. This coalescence can be achieved by melting the two parts together – *fusion welding* – or by bringing the two parts together under pressure, perhaps with the application of heat, to form a metallic bond across the interface. This is known as *solid phase joining* and is one of the oldest of the joining techniques, blacksmith’s hammer welding having been used for iron implement manufacture for some 3500 years. The more modern solid phase techniques are typified by friction welding. *Brazing*, also an ancient process, is one that involves a *brazing metal* which melts at a temperature above 450 °C but below the melting temperature of the components to be joined so that there is no melting of the parent metals. *Soldering* is an almost identical process, the fundamental difference being that the melting point of the solder is *less* than 450 °C. The principal processes used for the joining of aluminium are listed in Table 1.2. Not all of these processes are covered in this book as they have a very limited application or are regarded as obsolescent.

Welding that involves the melting and fusion of the parent metals only is known as *autogenous* welding, but many processes involve the addition

*Table 1.1* Typical forms and uses of aluminium alloys

Aluminium alloy Grade	Product form	Application
Pure aluminium	Foil, rolled plate, extrusions	Packaging and foil, roofing, cladding, low-strength corrosion resistant vessels and tanks
2000 series (Al-Cu)	Rolled plate and sheet, extrusions, forgings	Highly stressed parts, aerospace structural items, heavy duty forgings, heavy goods vehicle wheels, cylinder heads, pistons
3000 series (Al-Mn)	Rolled plate and sheet, extrusions, forgings	Packaging, roofing and cladding, chemical drums and tanks, process and food handling equipment
4000 series (Al-Si)	Wire, castings	Filler metals, cylinder heads, engine blocks, valve bodies, architectural purposes
5000 series (Al-Mg)	Rolled plate and sheet, extrusions, forgings, tubing and piping	Cladding, vessel hulls and superstructures, structural members, vessels and tanks, vehicles, rolling stock, architectural purposes
6000 series (Al-Si-Mg)	Rolled plate and sheet, extrusions, forgings, tubing and piping	High-strength structural members, vehicles, rolling stock, marine applications, architectural applications.
7000 series (Al-Mg-Zn)	Rolled plate and sheet, extrusions, forgings	High strength structural members, heavy section aircraft forgings, military bridging, armour plate, heavy goods vehicle and rolling stock extrusions

*Table 1.2* Principal processes for the welding of aluminium

Process	Application
<b>Fusion welding</b>	
Tungsten inert gas	High-quality, all position welding process that utilises a non-consumable electrode; may be used with or without wire additions; may be manual, mechanised or fully automated; low deposition rate, higher with hot wire additions; straight or pulsed current.
Metallic arc inert gas shielded	High-quality, all position welding process that utilises a continuously fed wire; may be manual, mechanised or fully automated; can be high deposition rate; twin wire additions; straight or pulsed current.

Table 1.2 (cont.)

Process	Application
Manual metal arc	Limited application; uses a flux-coated consumable electrode; non- or lightly stressed joints; obsolescent.
Oxy-gas	Low-quality weld metal; unstressed joints; obsolescent.
Electron beam welding	High-quality, precision welding; aerospace/defence and electronic equipment; high capital cost; vacuum chamber required.
Laser welding	High-quality, precision welding; aerospace/defence and electronic equipment; high capital cost.
Electro-gas, electro-slag, submerged arc	Limited applications, e.g. large bus bars; porosity problems; largely obsolescent.
<b>Welding with fusion and pressure</b>	
Magnetically impelled arc butt welding	Butt joints in pipe; capital equipment required but lower cost than flash butt; fully automated.
<b>Resistance and flash welding</b>	
Spot, projection spot seam welding	Lap joints in sheet metal work, automotive, holloware, aerospace industry; high capital cost; high productivity.
Weld bonding	Combination of spot welding through an adhesively bonded lap joint; automotive industry; very good fatigue strength.
High-frequency induction seam	Butt joints; production of pipe from strip; high capital cost; high production rates.
Flash butt welding	In line and mitre butt joints in sheet, bar and hollow sections; dissimilar metal joints, e.g. Al-Cu; high capital cost; high production rates.
<b>Stud welding</b>	
Condenser, capacitor discharge	Stud diameters 6mm max, e.g. insulating pins, pan handles, automotive trim, electrical contacts.
Drawn arc	Stud diameters 5–12mm.
<b>Solid phase bonding</b>	
Friction welding	Butt joints in round and rectangular bar and hollow sections; flat plate and rolled section butt welds (friction stir); dissimilar metal joints; capital equipment required.
Explosive welding	Field pipeline joints; dissimilar metal joints, surfacing.
Ultrasonic welding	Lap joints in foil; thin to thick sections; Al-Cu joints for electrical terminations.
Cold pressure welding	Lap and butt joints, e.g. Al-Cu, Al-steel, Al sheet and wire.
Hot pressure welding	Roll bonded lap joints, edge to edge butt joints.

of a *filler metal* which is introduced in the form of a wire or rod and melted into the joint. Together with the melted parent metal this forms the weld metal. Definitions of the terms used to describe the various parts of a welded joint are given in Chapter 5.

## 2.1 Introduction

Ideally a weldment – by this is meant the *complete* joint comprising the weld metal, heat affected zones (HAZ) and the adjacent parent metal – should have the same properties as the parent metal. There are, however, a number of problems associated with the welding of aluminium and its alloys that make it difficult to achieve this ideal. The features and defects that may contribute to the loss of properties comprise the following:

- Gas porosity.
- Oxide inclusions and oxide filming.
- Solidification (hot) cracking or hot tearing.
- Reduced strength in the weld and HAZ.
- Lack of fusion.
- Reduced corrosion resistance.
- Reduced electrical resistance.

This chapter deals with the first four of these problem areas, i.e. those of porosity, oxide film removal, hot cracking and a loss of strength. Before discussing these problems, however, there is a brief introduction as to how metals achieve their mechanical properties. Some of the terms used to describe specific parts of a welded joint are shown in Fig. 2.1.

## 2.2 Strengthening mechanisms

There are five separate strengthening mechanisms that can be applied to the aluminium alloys. These are grain size control, solid solution alloying, second phase formation, strain hardening (cold work) and precipitation or age hardening.



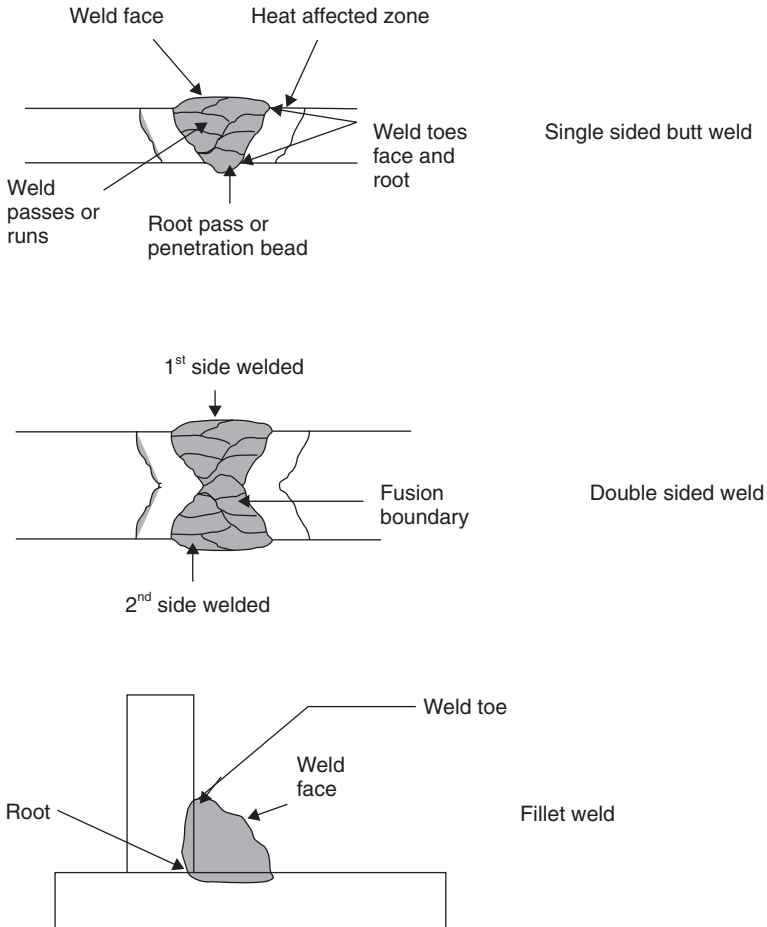

2.1 Definition of weld features.

### 2.2.1 Structure of metals

Before discussing the principles by which metals achieve their mechanical strength it is necessary to have an appreciation of their structure and how these structures can be manipulated to our benefit. The simple model of an atom is of a number of electrons in different orbits circling a central nucleus. In a metal the electrons in the outer orbit are free to move throughout the bulk of the material. The atoms, stripped of their outer electrons, become positively charged ions immersed in a 'cloud' of negatively charged electrons. It is the magnetic attraction between the positively charged ions and the cloud of mobile, negatively charged electrons that binds the metal together. These atomic scale events give metals their high thermal and

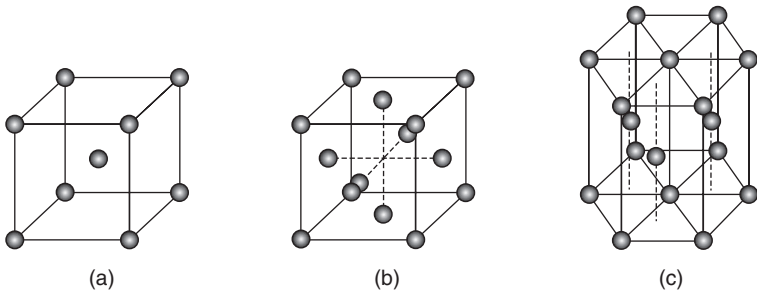

2.2 The three crystalline forms of metals: (a) body-centred cubic; (b) face-centred cubic; (c) close-packed hexagonal. (From John Lancaster, *Metallurgy of Welding*, 6th edn, 1999.)

electrical conductivity and the ability to deform extensively before fracturing by a process known as *slip*, where one *plane* of atoms slides over its neighbours.

In metals the atoms are arranged in a regular three-dimensional pattern repeated over a long distance on what is termed a *space lattice*. Conventionally, these atoms are visualised as solid spheres. The smallest atomic arrangement is the *unit cell*, the least complicated unit cell being the simple cube with an atom at each corner of the cube. In metals the three most common arrangements are *body-centred cubic* (BCC), *face-centred cubic* (FCC) and *hexagonal close packed* (HCP). Schematic views of the three structures are given in Fig. 2.2.

Each crystal structure confers certain physical properties on the metal. The face-centred cubic metals, of which aluminium is one, are ductile, formable and have high toughness at low temperatures. Although single crystals can be obtained it is more common for metals to be *polycrystalline*, that is, made up of a very large number of small grains. Each grain is a crystal with a regular array of atoms but at the boundaries between the grains there is a mismatch, a loss of order, in the orientation of these arrays. Both the grain boundaries and the size of the grains can have a marked effect on the properties of the metal.

### 2.2.2 Grain size control

Grain size is not generally used to control strength in the aluminium alloys, although it is used extensively in reducing the risk of hot cracking and in controlling both strength and notch toughness in C/Mn and low-alloy steels. In general terms, as grain size increases, the yield and ultimate tensile strengths of a metal are reduced. The yield strength  $\sigma_y$ , is related to the grain size by the Hall–Petch equation:

$$\sigma_y = \sigma_1 + k_y d^{-1/2}$$

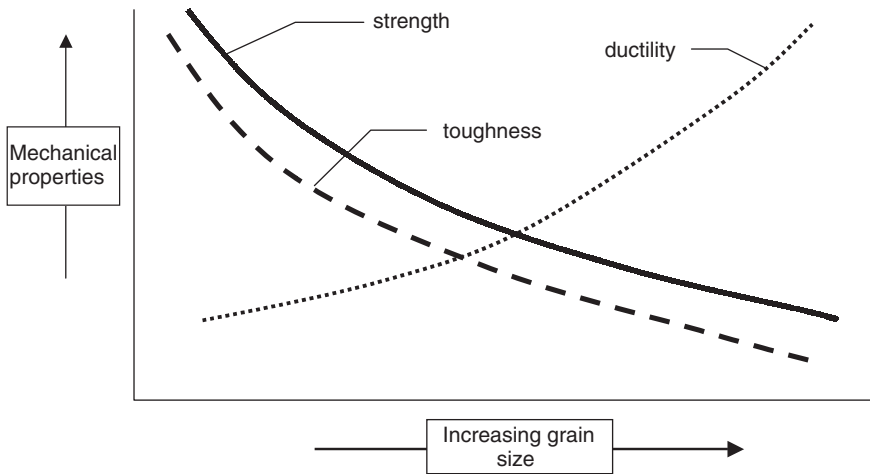

2.3 General relationship of grain size with strength, ductility and toughness.

where  $d$  is the average grain diameter, and  $\sigma_1$  and  $k_y$  are constants for the metal. Typical results of this relationship are illustrated in Fig. 2.3.

The practical consequence of this is that a loss of strength is often encountered in the HAZ of weldments due to *grain growth* during welding. A loss of strength may also be found in the weld metal which is an as-cast structure with a grain size larger than that of the parent metal. In the aluminium alloys the strength loss due to grain growth is a marginal effect, with other effects predominating. Grain size does, however, have a marked effect on the risk of hot cracking, a small grain size being more resistant than a large grain size. Titanium, zirconium and scandium may be used to promote a fine grain size, these elements forming finely dispersed solid particles in the weld metal. These particles act as nuclei on which the grains form as solidification proceeds.

### 2.2.3 Solid solution strengthening

Very few metals are used in the pure state, as generally the strength is insufficient for engineering purposes. To increase strength the metal is *alloyed*, that is mixed with other elements, the type and amount of the alloying element being carefully selected and controlled to give the desired properties. An alloy is a metallic solid formed by dissolving, in the liquid state, one or more *solute* metals, the alloying elements, in the bulk metal, the *solvent*. On cooling the alloy solidifies as a *solid solution* which can exist over a range of compositions, all of which will be homogeneous. Depending upon the metals involved a *limit of solid solubility* may be

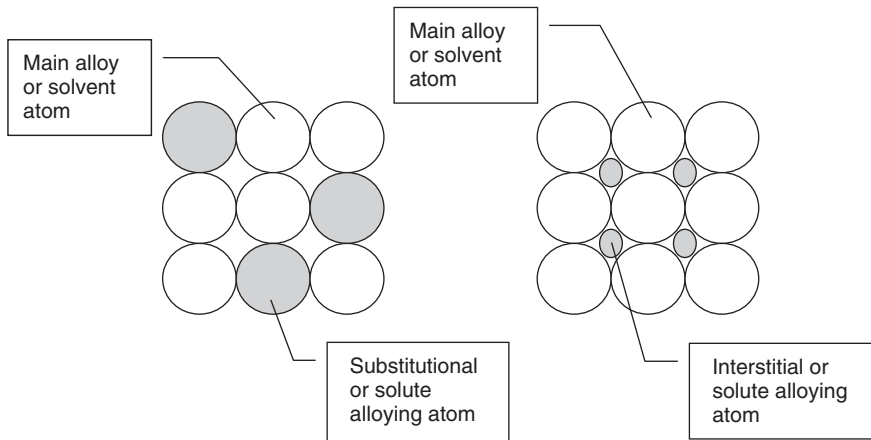

2.4 Schematic illustration of substitutional and interstitial alloying.

reached. Microscopically a solid solution is featureless but once the limit of solid solubility is reached a second component or *phase* becomes visible. This phase may be a *secondary solid solution*, an *inter-metallic compound* or the pure alloying element. The introduction of a second phase results in an increase in strength and hardness, for instance iron carbide ( $\text{Fe}_3\text{C}$ ) in steels, copper aluminide ( $\text{CuAl}_2$ ) in the aluminium–copper alloys and silicon (Si) in the aluminium–silicon alloys.

In solid solution alloying the alloying element or solute is completely dissolved in the bulk metal, the solvent. There are two forms of solid solution alloying – *interstitial* and *substitutional* – illustrated in Fig. 2.4. Interstitial alloying elements fit into the spaces, the interstices, between the solvent atoms, and substitutional elements *replace or substitute for* the solvent atoms, provided that the diameter of the substitutional atom is within  $\pm 15\%$  of the solvent atomic diameter. The effect of these alloying elements is to distort the space lattice and in so doing to introduce a strain into the lattice. This strain increases the tensile strength but as a general rule decreases the ductility of the alloy by impeding the slip between adjacent planes of atoms.

Many elements will alloy with aluminium but only a relatively small number of these give an improvement in strength or weldability. The most important elements are silicon, which increases strength and fluidity; copper, which can give very high strength; magnesium which improves both strength and corrosion resistance; manganese, which gives both strength and ductility improvements; and zinc, which, in combination with magnesium and/or copper, will give improvements in strength and will assist in regaining some of the strength lost when welding.

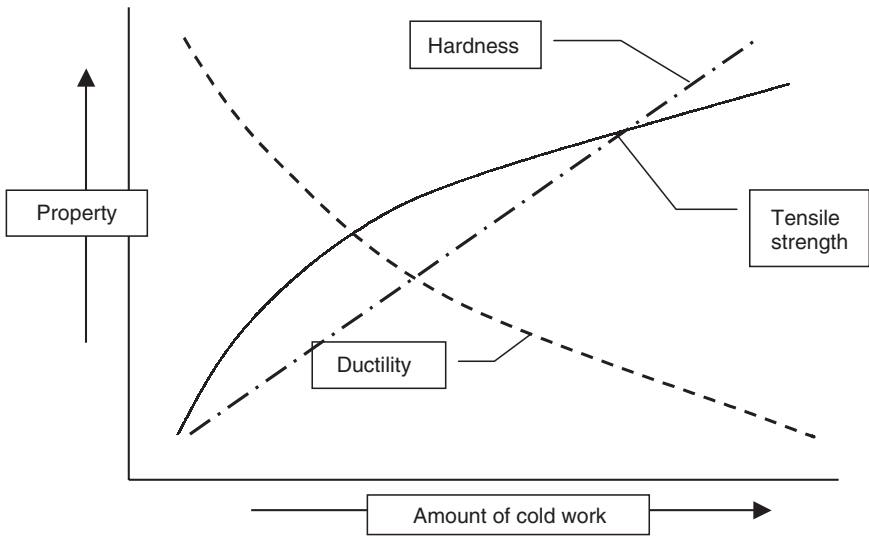

2.5 Illustration of the effect of cold work on strength, hardness and ductility.

## 2.2.4 Cold working or strain hardening

*Cold work, work hardening or strain hardening* is an important process used to increase the strength and/or hardness of metals and alloys that cannot be strengthened by heat treatment. It involves a change of shape brought about by the input of mechanical energy. As deformation proceeds the metal becomes stronger but harder and less ductile, as shown in Fig. 2.5, requiring more and more power to continue deforming the metal. Finally, a stage is reached where further deformation is not possible – the metal has become so brittle that any additional deformation leads to fracture. In cold working one or two of the dimensions of the item being cold worked are reduced with a corresponding increase in the other dimension(s). This produces an elongation of the grains of the metal in the direction of working to give a *preferred grain orientation* and a high level of internal stress.

The increase in internal stress not only increases strength and reduces ductility but also results in a very small decrease in density, a decrease in electrical conductivity, an increase in the coefficient of thermal expansion and a decrease in corrosion resistance, particularly stress corrosion resistance. The amount of distortion from welding is also likely to be far greater than from a metal which has not been cold worked.

If a cold worked metal is heated a temperature is reached where the internal stresses begin to relax and *recovery* begins to take place. This restores most of the physical properties of the unworked metal but without any observable change in the grain structure of the metal or any major change in mechanical properties. As the temperature is increased, *recrystallisation* begins to occur where the cold worked and deformed crystals are replaced by a new set of strain-free crystals, resulting in a reduction in strength and an increase in ductility. This process will also result in a fine grain size, perhaps finer than the grain size of the metal before cold working took place. It is possible therefore to *grain refine* a metal by the correct combination of working and heat treatment. On completion of recrystallisation the metal is said to be *annealed* with the mechanical properties of the non-cold-worked metal restored.

At temperatures above the recrystallisation temperature the new grains begin to grow in size by absorbing each other. This *grain growth* will result in the formation of a coarse grained micro-structure with the grain size depending upon the temperature and the time of exposure. A coarse grain size is normally regarded as being undesirable from the point of view of both mechanical properties and weldability.

## 2.2.5 Precipitation (age) hardening

Microstructures with two or more phases present possess a number of ways in which the phases can form. The geometry of the phases depends on their relative amounts, whether the minor phase is dispersed within the grains or is present on the grain boundaries and the size and shape of the phases. The phases form by a process known as *precipitation*, which is both time and temperature controlled and which requires a reduction in solid solubility as the temperature falls, i.e. more of the solute can dissolve in the solvent at a high temperature than at a low temperature. A simple analogy here is salt in water – more salt can be dissolved in hot water than in cold. As the temperature is allowed to fall, the solution becomes *saturated* and crystals of salt begin to precipitate.

A similar effect in metals enables the microstructure of a precipitation hardenable alloy to be precisely controlled to give the desired mechanical properties. To precipitate or age harden an alloy the metal is first of all heated to a sufficiently high temperature that the second phase goes into solution. The metal is then ‘rapidly’ cooled, perhaps by quenching into water or cooling in still air – the required cooling rate depends upon the alloy system. Most aluminium alloys are quenched in water to give a very fast cooling rate. This cooling rate must be sufficiently fast that the second phase does not have time to precipitate. The second phase is retained in solution at room temperature as a *super-saturated* solid solution which is *metastable*,

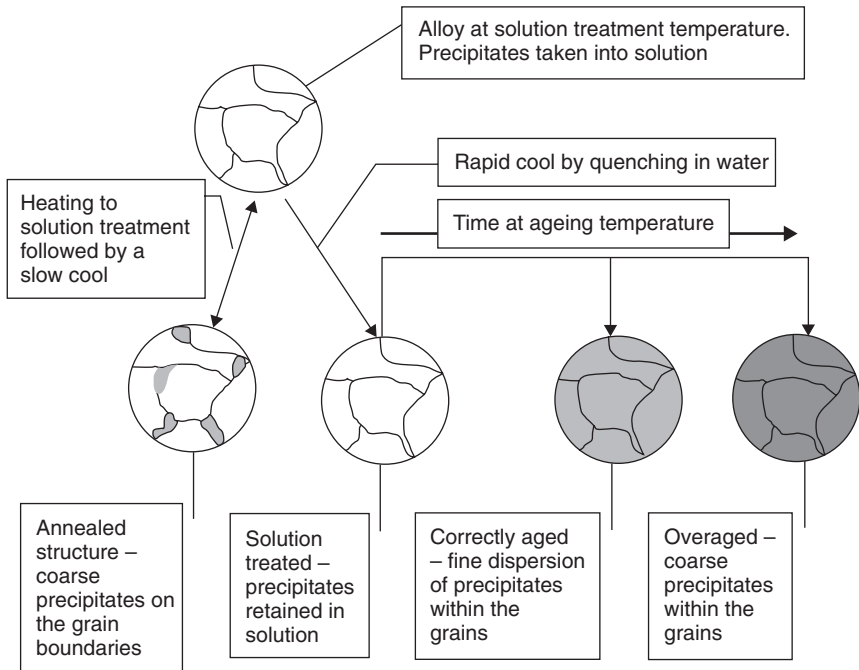

2.6 Illustration of the solution treatment and age-(precipitation) hardening heat treatment cycle.

that is, the second phase will precipitate, given the correct stimulus. This stimulus is *ageing*, heating the alloy to a low temperature. This allows diffusion of atoms to occur and an extremely fine precipitate begins to form, so fine that it is not resolvable by normal metallographic techniques. This precipitate is said to be *coherent*, the lattice is still continuous but distorted and this confers on the alloy extremely high tensile strength. In this world, there is no such thing as a free lunch, so there is a marked drop in ductility to accompany this increase in strength.

If heating is continued or the ageing takes place at too high a temperature the alloy begins to *overage*, the precipitate coarsens, perhaps to a point where it becomes metallographically visible. Tensile strength drops but ductility increases. If the overageing process is allowed to continue then the alloy will reach a point where its mechanical properties match those of the annealed structure.

Too slow a cooling rate will fail to retain the precipitate in solution. It will form on the grain boundaries as coarse particles that will have a very limited effect on mechanical properties. The structure is that of an annealed metal with identical mechanical properties. The heat treatment cycle and its effects on structure are illustrated in Fig. 2.6.

*Table 2.1* Summary of mechanical properties for some aluminium alloys

Alloy	Condition	Proof (Nmm <sup>2</sup> )	UTS (Nmm <sup>2</sup> )	Elongation (%)
1060	O	28	68	43
1060	H18	121	130	6
5083	O	155	260	14
5083	H34	255	325	5
6063	O	48	89	32
6063	TB(T4)	100	155	15
6063	TF(T6)	180	200	8
2024	O	75	186	20
2024	TB(T4)	323	468	20

UTS: ultimate tensile strength

## 2.2.6 Summary

This chapter is only the briefest of introductions to the science of metals, how crystal structures affect the properties and how the fundamental mechanisms of alloying, hardening and heat treatment, etc., are common to all metals. Table 2.1 gives the effects of solid solution strengthening, cold working and age hardening. It illustrates how by adding an alloying element such as magnesium, the strength can be improved by solid solution alloying from a proof strength of 28 N/mm<sup>2</sup> in an almost pure alloy, 1060, to 115 N/mm<sup>2</sup> in an alloy with 4.5% magnesium, the 5083 alloy. Similarly, the effects of work hardening and age hardening can be seen in the increases in strength in the alloys listed when their condition is altered from the annealed (O) condition. Note, however, the effect that this increase in strength has on the ductility of the alloys.

## 2.3 Aluminium weldability problems

### 2.3.1 Porosity in aluminium and its alloys

Porosity is a problem confined to the weld metal. It arises from gas dissolved in the molten weld metal becoming trapped as it solidifies, thus forming bubbles in the solidified weld (Fig. 2.7).

Porosity can range from being extremely fine micro-porosity, to coarse pores 3 or 4 mm in diameter. The culprit in the case of aluminium is hydrogen, which has high solubility in molten aluminium but very low solubility in the solid, as illustrated in Fig. 2.8. This shows a decrease of solubility to the order of 20 times as solidification takes place, a drop in solubility so



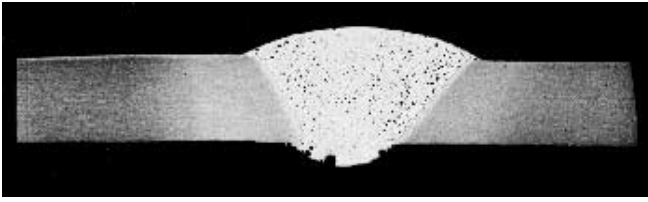

2.7 Finely distributed porosity in TIG plate butt weld 6mm thickness. Courtesy of TWI Ltd.

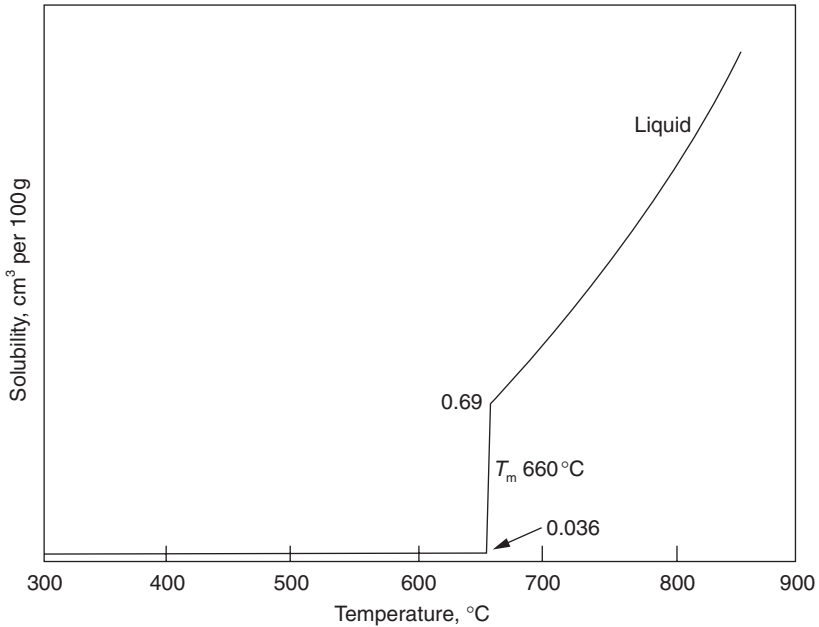

2.8 Solubility of hydrogen in aluminium.

pronounced that it is extremely difficult to produce a porosity-free weld in aluminium.

Porosity tends to be lowest in autogenous welds. When filler metal is used porosity levels tend to increase because of contamination from the wire. Of the conventional fusion welding processes TIG has lower levels of porosity than MIG due to this hydrogen contamination of the wire. Increasing the arc current increases the temperature of the weld pool and thereby increases the rate of absorption of hydrogen in the molten metal. Conversely, in the flat welding position increasing the heat input can reduce porosity when the rate of gas evolution from the weld exceeds the rate of absorption – slowing the rate at which the weld freezes allows the

hydrogen to bubble out of the weld. A similar effect can be achieved by reducing the travel speed. Increasing arc voltage and/or arc length increases the exposure of the molten metal to contamination, and porosity will thereby increase. The alloy composition can also influence the amount of porosity by changing the solubility of hydrogen – magnesium in particular has a beneficial effect. It is thought that magnesium raises the solubility and reduces absorption of hydrogen by as much as twice at 6% Mg. Copper and silicon have the opposite effect. A conclusion that can be drawn from this is that when porosity is encountered the use of Al-Mg filler can assist in reducing the problem. This assumes of course that such filler metal is acceptable in the specific application.

The sources of hydrogen are many and varied but one of the primary sources is the welding consumables. Moisture is an intrinsic part of the flux in any of the flux shielded processes such as manual metallic arc (MMA) or SMA (shielded metal arc), and submerged arc (SA) welding. During welding this moisture decomposes in the arc to give hydrogen, resulting in a large amount of porosity. This is one reason why these processes are not widely used to weld aluminium.

The gas used in the gas shielded processes is another source of moisture which is easy to overlook. Ideally gas with a dew point of less than  $-50^{\circ}\text{C}$  (39 ppm water) should be used. To achieve such a high purity it is essential to purchase the gas with a guaranteed low dew point. It is also necessary to ensure that when it is delivered to the weld pool it has maintained this high degree of purity. This means that the gas supply system should be checked at regular intervals for leaks, that damaged hoses are replaced immediately and joints are sound. When faced with a porosity problem the gas purity should be checked first of all at the *torch nozzle* before working back along the gas delivery system in a logical manner to locate the source of contamination. If the workshop layout permits it is recommended that the gas is supplied from a bulk tank rather than from cylinders and distributed around the workplace in copper or steel piping. Despite the best efforts of the gas suppliers it is not always possible to guarantee completely the purity of individual bottles except at great expense. Bulk supplies are generally of superior quality. Screwed or bolted flanged connections are potential sources of contamination and leaks and are best avoided by the use of a brazed or welded system.

A further source of contamination may come from the gas hoses themselves. Many of the plastics used for gas hoses are porous to the water present in the air. This results in moisture condensing on the *inside* of the hose and being entrained in the shield gas. A number of reports published recently have identified the permeability of hose compositions and a summary of the results is presented in Table 2.2. From this it can be seen that only a limited number of hose compositions will maintain gas purity.

Table 2.2 Moisture permeability of gas hoses

Permeability	Common name	Hose composition
Highest	Natural rubber	Isoprene
	Neoprene	Polychloroprene
	PVC	Polyvinylchloride
		Low-density polyethylene
		Polypropylene
		High-density polyethylene
Lowest	Teflon	Polytetrafluoroethylene Polytrifluoro-chloroethylene

Of the plastic tubing the most porous is neoprene rubber, the least porous polytrifluoro-chloroethylene. The best of all is an all-metal system. Any plastic hoses should be kept as short and as small a diameter as possible consistent with the application.

Also important is the fact that the moisture collects in the tube over a period of time when no gas is flowing. The implication of this is that if welding equipment is left idle for long periods of time the first few welds to be made on recommencing welding may contain unacceptable porosity. A systematic porosity problem always occurring, for example, at the commencement of the first shift after a weekend break may be an indication of this problem. Flushing the hoses through for a short time by operating the torch trigger may help to reduce the amount of porosity. If this is done with the MIG (GMAW, gas metal-arc welding) torch do not forget to slacken off the wire drive rolls!

TIG welding wire should be cleaned with a lint-free cloth and a good degreasant before use. Once the wire has been cleaned do not handle the wire with bare hands but use a clean pair of gloves, store the wire in clean conditions and weld within a short time of cleaning. For the MIG process there are devices available that can be fitted around the wire where it enters the torch liner in the wire feed unit and that will clean the wire as it passes through. Best of all the wire should be shaved to remove any contaminants and oxides that may have been pressed into the surface during the wire drawing operation.

Cleanliness of the parent metal is also extremely important in achieving low levels of porosity – it cannot be emphasised too strongly how important this is. Thorough degreasing is essential, followed by a mechanical cleaning such as stainless steel wire brushing to remove the oxide layer which may be hydrated. Once degreased and wire brushed the parent material should be welded within a short period of time, a period of four hours frequently being regarded as acceptable. Further details of mechanical cleaning, degreasing and workshop conditions are given in Chapter 4.

Table 2.3 Summary of causes and prevention of porosity

Mechanism of porosity formation	Potential causes	Remedial measures
Hydrogen entrapment	Oxide film, grease, drawing soap on filler wire; oxides, grease, dirt on parent plate; dirt/grease in liner; contaminated shield gas; water leaks in torch; spatter on weld face.	Clean wire, use high-quality gas, change liner, protect wire from contamination, change torch, clean plate, minimise spatter.
Gas/air entrapment	(a) Weld pool turbulence due to high current. (b) Gas expanding from root of partial penetration/fillet welds.	(a) Use lower current, reduce travel speed, change gun angle. (b) Use full pen weld, allow gap in fillet weld root, use high heat input.
Rapid freezing trapping gas	Heat input too low, rapid heat loss, viscous weld pool, cold backing bar.	Increase current, slow travel speed, consider preheat, heat backing bar, replace argon shield gas with helium.
Erratic wire feed	Kinked, blocked or wrong size liner, incorrect or badly adjusted drive rolls, damaged contact tip, unstable power supply.	Straighten wire conduit, replace contact tip, adjust drive roll pressure, fit correct liner, fit grooved rolls.

A last source of porosity may be hydrogen dissolved within the aluminium. Although solubility of hydrogen is low in the solid phase there can be sufficient in the parent metal to give a problem on welding. This is unlikely in wrought products but may arise when welding castings or sintered products. For this reason some purchasers specify in their purchase orders a limit on hydrogen, typically 2ppm. Avoidance of porosity when hydrogen is present in the parent metal is impossible to avoid.

Table 2.3 summarises the causes and prevention of porosity.

### 2.3.2 Oxide film removal during welding

The need to remove the oxide film prior to welding to reduce the risk of porosity has been covered above. It is also necessary to disperse this film

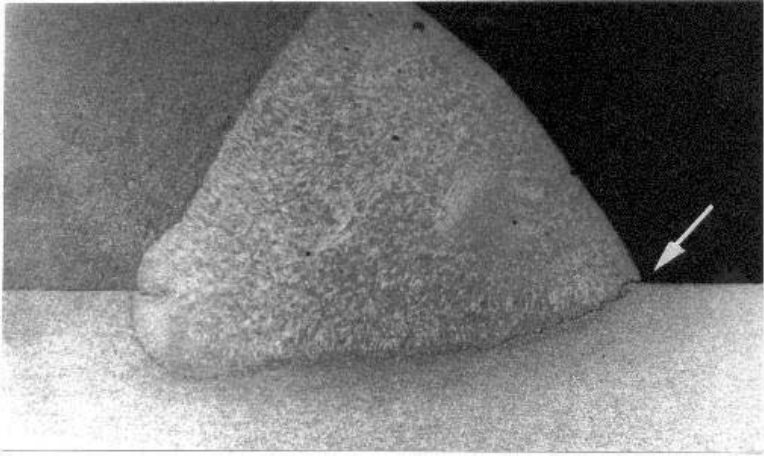

2.9 Oxide entrapment in fillet weld. Courtesy of Roland Andrews.

during welding if defects such as lack of fusion and oxide film entrapment are to be avoided. Figure 2.9 illustrates oxide filming in a fillet weld that will obviously have a pronounced effect on joint strength.

Aluminium oxide ( $\text{Al}_2\text{O}_3$ ) is a very tenacious and rapid-forming oxide which gives aluminium its excellent corrosion resistance. Aluminium oxide has a very high melting point,  $2060^\circ\text{C}$  compared with the pure metal which melts at  $660^\circ\text{C}$ . The oxides of most other metals melt at temperatures at or below that of their metals and during welding will float on top of the weld pool as a molten slag. Heating aluminium to its melting point without dispersing the oxide film will result in a molten pool of aluminium enclosed in a skin of oxide, rather like a rubber toy balloon filled with water. This skin has to be removed by some suitable means. With fluxed processes, soldering, brazing, MMA and SA welding, the flux needs to be very aggressive to dissolve the film. Failure to remove these fluxes on completion can give rise to service failures from corrosion and, in addition to porosity, is a further reason why MMA and SA welding are rarely used.

Fortunately, in gas shielded arc welding there is a phenomenon known as *cathodic cleaning* which can be employed to give the desired result. When the electrode is connected to the positive pole of the power source and direct current is passed there is a flow of electrons from the workpiece to the electrode with ions travelling in the opposite direction and bombarding the workpiece surface. This ion bombardment breaks up and disperses the oxide film and permits the weld metal to flow and fuse with the parent metal. The MIG welding process uses only DC electrode positive (DCEP) current – using DC electrode negative (DCEN) results in an unstable arc,

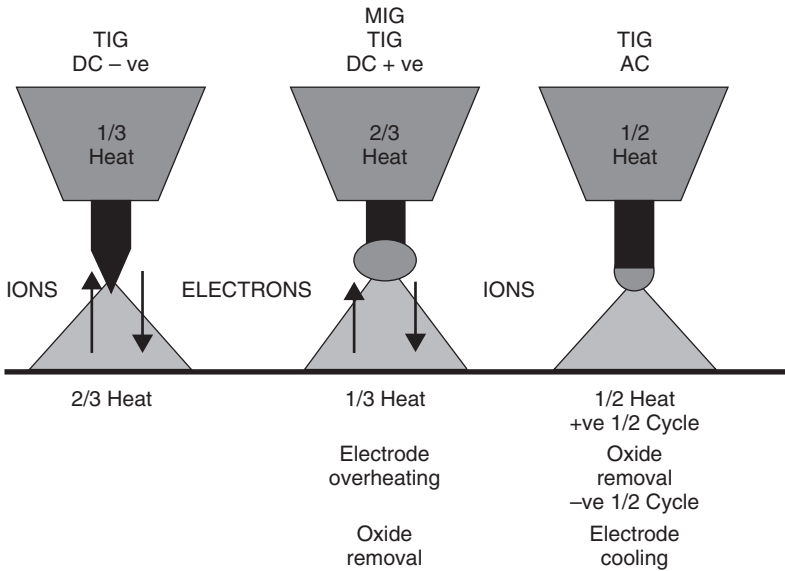

2.10 Effect of polarity on cathodic cleaning and heat balance.

erratic metal transfer and poor weld quality. Oxide film removal is therefore an intrinsic part of the MIG process.

TIG welding, on the other hand, conventionally uses DCEN, which, if used on aluminium, can result in poor weld quality. Using DCEP with TIG, however, results in the tungsten electrode overheating as some 60–70% of the heat generated in a TIG welding arc may be produced at the positive pole. (Conventionally a rule of thumb for the heat balance in a TIG arc is regarded as being two-thirds at the positive pole, one-third at the negative pole. This, however, varies widely depending upon the shield gas, current, arc length, etc.) This can cause melting of the electrode and bring the welding operation to a premature end. A compromise is therefore reached by using AC where oxide film removal takes place on the positive half cycle and electrode cooling on the negative half cycle as illustrated in Fig. 2.10. TIG welding of aluminium is therefore normally carried out with AC, although there are a couple of techniques that use either DCEP or DCEN. These will be discussed in Chapter 6 on TIG welding.

### 2.3.4 Hot cracking

Hot cracking is a welding problem that does not occur in pure metals but may be found in certain alloy systems. It is not confined to the aluminium alloys but is also encountered in steels, nickel and copper alloys. The funda-

mental mechanism is the same in all of the alloy systems and is a function of how metal alloy systems solidify. As the name suggests, this is a high-temperature cracking mechanism which, because of its prevalence, is known by a number of different names – hot cracking, hot fissuring, hot shortness, liquation cracking, centre-line cracking or solidification cracking.

The addition of alloying elements to a pure metal will cause a change in the freezing temperature of the alloy from that of the pure metal and may result in a number of different *phases* – a solid solution, a eutectic and an intermetallic compound, for instance, being produced. These changes of state and the relative proportions of each phase are represented on *phase diagrams*. It is not intended to go into any greater detail than this – for further information refer to the books listed in the Bibliography. The lowest melting point composition of the alloy is known as the *eutectic* composition which freezes at one specific temperature. The other non-eutectic compositions freeze over a range.

It is necessary next to look at how a metal solidifies. Figure 2.11 shows the way in which the lowest melting point constituents are pushed to the grain boundaries by the solidification fronts as the solid particles grow in size.

The first solid to form is a unit cell that acts as a nucleus to which atoms attach themselves, forming what is known as a *dendrite*. The dendrite increases in size until such time as it begins to collide with its neighbours that have been nucleating and growing in a similar manner. The point at which this collision takes place becomes the boundary between adjacent dendrites, *crystals* or *grains* – the grain boundary. Since almost all alloy systems, except eutectics, solidify over a range of temperatures, it is common sense to expect that the first metal to solidify will be the highest melting/freezing point alloy and the last to be the lowest melting point composition, always the eutectic if one has formed. The consequence of this solidification process is that the lowest melting point alloy composition is pushed ahead of the solidifying dendrite until it becomes trapped between the adjacent dendrites, i.e. along the grain boundaries. If the difference in melting point between the low melting point eutectic and the bulk of the metal is sufficiently great then the liquid film along the grain boundaries may part as the metal cools and contracts. The results of this are illustrated in Fig. 2.12.

In most metals this effect is caused by tramp elements or impurities. Sulphur in steel and nickel alloys is a good example where low melting point sulphide eutectics are formed. In the aluminium alloys, however, it is the *deliberately added* alloying elements themselves that form a range of eutectics with freezing points substantially lower than the bulk metal. This means that *all* aluminium alloys are susceptible to some degree to this form of cracking, differing only in their degree of susceptibility. Cracking tests have

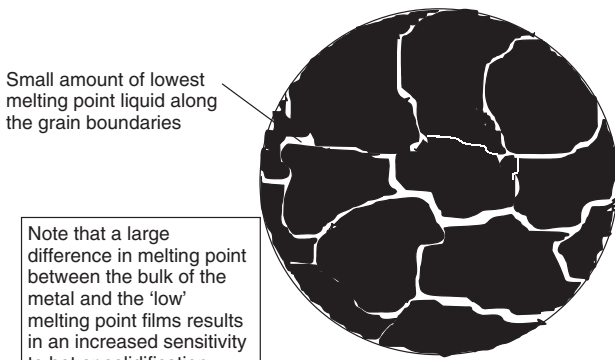
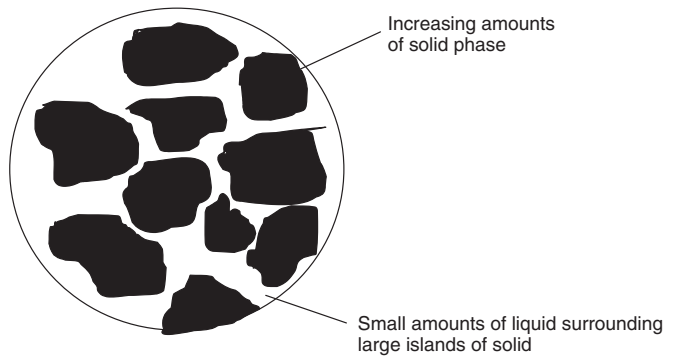
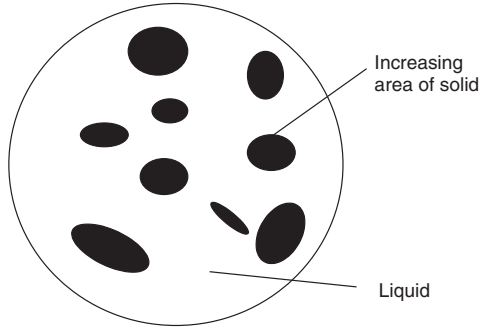
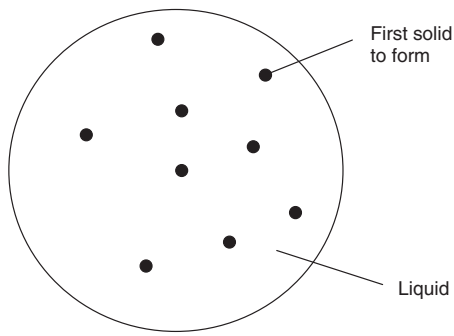

Note that a large difference in melting point between the bulk of the metal and the 'low' melting point films results in an increased sensitivity to hot or solidification cracking

2.11 Solidification of a metal.



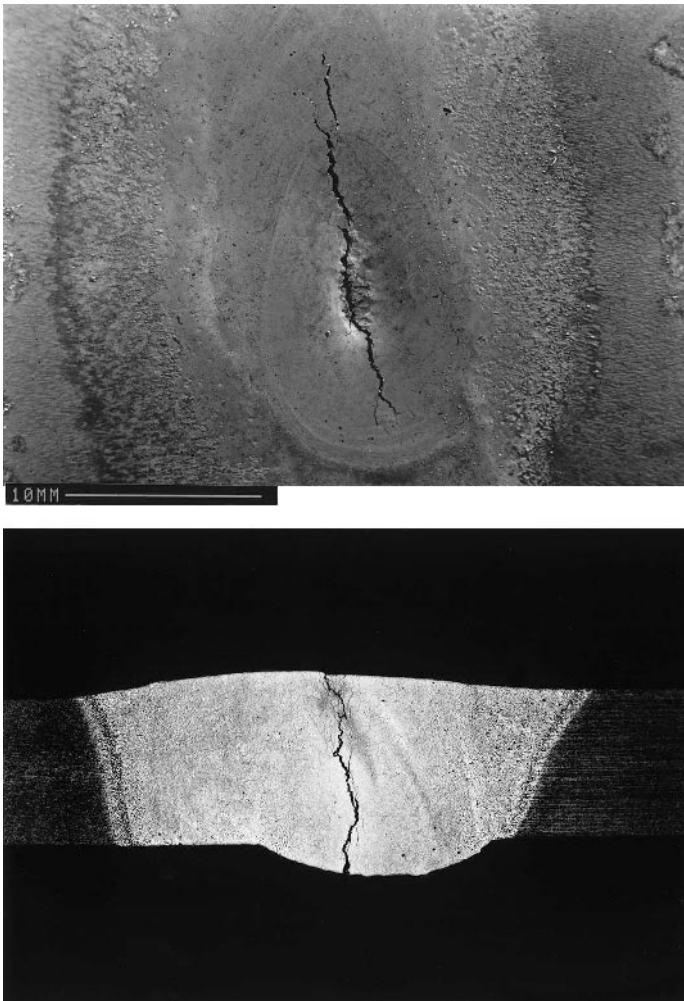

2.12 Solidification cracking: (a) in the finish crater of a TIG weld in A5083 alloy; (b) in a 3 mm thick A6082 plate/4043 filler metal TIG weld. Courtesy of TWI Ltd.

determined what is termed the *hot short range*, the range of composition within which the alloy has a high risk of hot cracking. The hot short range of the common alloying elements is given in Table 2.4.

These results are produced by performing standard cracking tests. These tests are designed to load the weld transversely under controlled conditions to give cracks, the length of which will be a measure of the crack sensitivity of the specific alloy being tested. This enables the alloys to be ranked in order of sensitivity and characteristics such as the hot short range to be determined.

Table 2.4 Hot short range and eutectic characteristics

Alloy system	Hot short range composition %	Eutectic	
		Temp. (°C)	Composition (%)
Al-Si	0.5 to 1.2	577	12.6
Al-Cu	2.0 to 4.0	548	33
Al-Mn	1.5 to 2.5	658	1.5
Al-Mg	0.5 to 2.5	450	36
Al-Zn	4.0 to 5.0	381	94
Al-Fe	1.0 to 1.5	655	2
Al-Li	Not available	596	7.5
Al-Ni	Not available	640	5.7

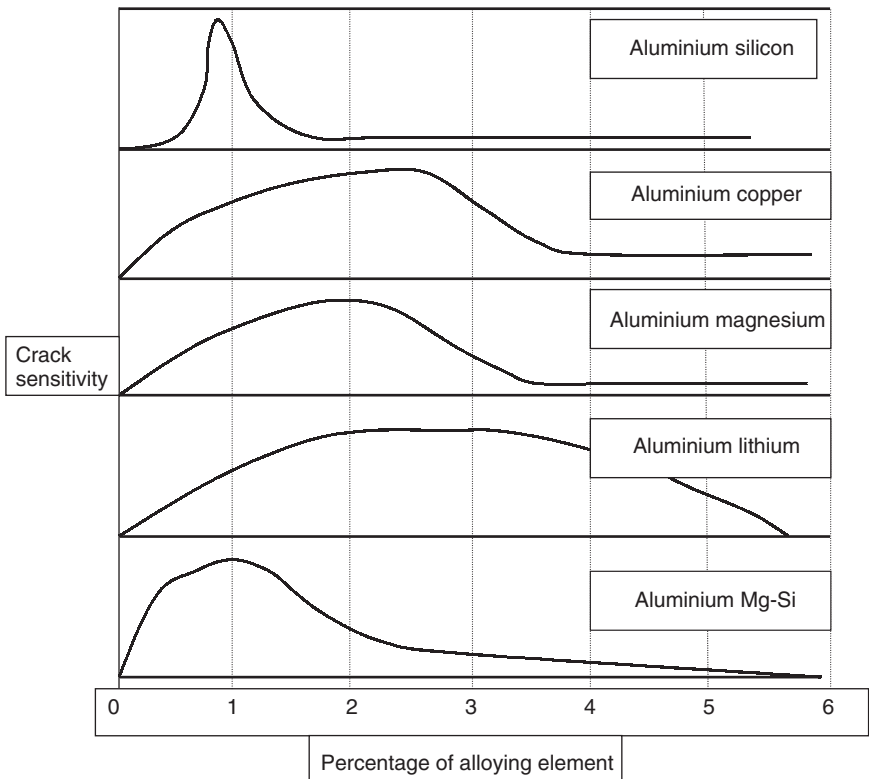

2.13 Effect of solute concentration on crack sensitivity.

The aluminium alloys all exhibit a peak in sensitivity with a high resistance to hot cracking at both low and high alloy content, as shown in Fig. 2.13. At low levels of alloy content there is only a small amount of eutectic present. This results in the liquid film on the grain boundaries being

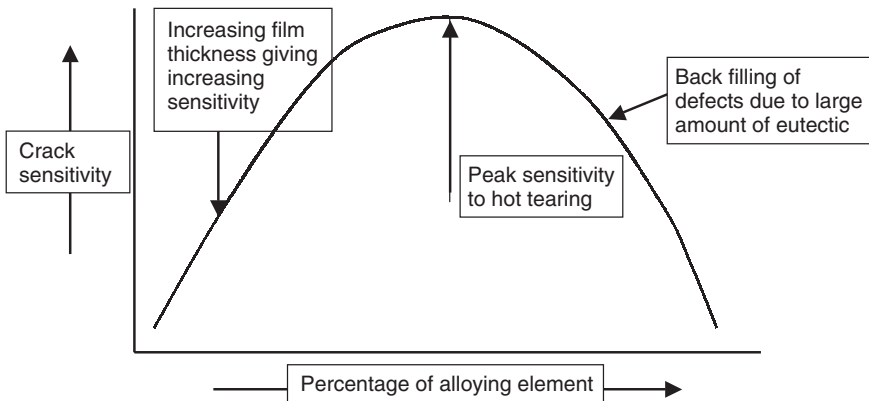

2.14 Generalised picture of crack sensitivity.

either discontinuous or very thin. The strength of a liquid film can be derived from

$$F = \frac{k\gamma A}{t}$$

where  $F$  = force required to tear the liquid;

$k$  = a constant;

$\gamma$  = the liquid/solid interfacial tension;

$A$  = cross-sectional area;

$t$  = liquid film thickness.

Therefore, as the liquid film thickness  $t$  increases, the force required to tear the film  $F$  reduces. The force required for cracking begins to increase, however, once there is sufficient eutectic available that it can begin to flow into and fill any cracks that form. The crack sensitivity therefore drops, the cracks heal themselves and a crack-free structure results. This is a very useful feature when welding alloys that are sensitive to liquation cracking in the HAZ. Figure 2.14 illustrates this graphically, where it can be seen that the shape of the curve is essentially the same as that in Fig. 2.13.

The practical consequence of this is that the crack susceptibility of the weld metal is very sensitive to changes in composition. In very many situations when welding aluminium alloys, the filler metal does not match the parent material. It is *most important* that this fact is realised and that account is taken of the composition of the resultant weld metal. There are a number of other factors, apart from filler metal and parent metal composition, which affect the weld metal composition. Fit-up of the component parts can affect the amount of *dilution* in a joint, dilution being the amount of parent metal dissolved into the weld metal during welding. In the root pass a wide gap will give low dilution, a narrow gap high dilution, as illustrated in Fig. 2.15.

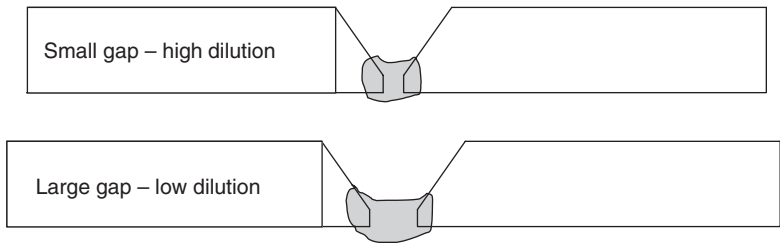

2.15 Effect of variations in root gap.

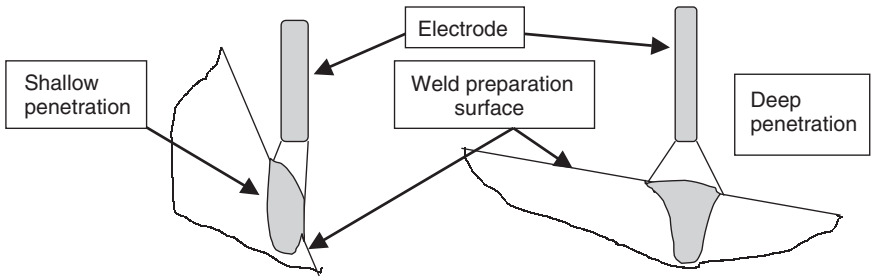

2.16 Effect of electrode angle on dilution.

A steep weld preparation bevel angle will give lower dilution than a wide shallow weld preparation because of the change in the angle of the electrode to the weld bevel, as shown in Fig. 2.16. Changing the welding process or the welding parameters, particularly the welding current, may also affect penetration and therefore dilution. From a shop-floor point of view this means that weld bevel angles, joint fit up and welding parameters need to be controlled far more closely than in the case of steel welding if problems of hot cracking are to be avoided.

In summary, if hot cracking is encountered it may be eliminated by one or more of the following:

- A small grain size. It has been found that small additions of elements such as titanium, zirconium or scandium will act as nuclei for the formation of a very fine grain during solidification. Filler metals can be purchased that are alloyed with titanium and/or zirconium.
- Control the composition of the weld pool by adding filler metal to produce an alloy that is not in the hot short range.
- Use an edge preparation and joint spacing to permit sufficient filler metal to be added to achieve a weld metal composition outside the hot short range.
- Use the highest welding speed. High speeds reduce the length of time the weld is within the hot short temperature range. High welding speeds

also reduce the size of the HAZ and consequently the shrinkage stresses across the joint.

- Use high-speed, small-volume multi-run procedures instead of large volume, single run deposits.
- Select welding and assembly sequences that minimise restraint and residual stresses.
- Apply an external force to maintain the weld in compression while it is in the hot short range.
- Select a filler metal with a melting point close to that of the parent metal, see Appendixes C and D.

## 2.4 Strength loss due to welding

In order to effect a weld the components to be joined are heated to a high temperature, in the case of fusion welding above the melting point of the parent metals, and brought together to enable the components to coalesce. The heat of the welding operation is conducted into the parent metal such that in any welded joint there are three distinct areas – the weld metal in a fusion welded joint, the HAZ in the parent material and the unaffected parent metal. The HAZ may be further subdivided into areas with particular properties depending upon the alloy system involved. Since the HAZ will have experienced one or more cycles of heating and cooling the properties may be radically different from those of the unaffected parent metal. This is particularly the case with those aluminium alloys that have been strengthened by either cold working or precipitation hardening. One aspect of this is the width of the HAZ, a function of the high thermal conductivity of aluminium and the consequent size of the area where there has been a substantial loss of strength. Only when the alloy is in the as-cast or annealed condition will the properties of the HAZ match those of the parent metal.

### 2.4.1 Weld metal

In a fusion weld the weld metal is an as-cast structure consisting of a mixture of the filler metal, if added, and the parent metal(s). The properties of this weld depend upon the composition, the quality and the grain size of the deposit. These in their turn depend on the parent and filler metal compositions, the amount of dilution, the quality of the welding process and the welder and, lastly, the rate of solidification. With the exception of a couple of 2XXX filler wires most filler metals available are not capable of being age hardened, although dilution with parent metal may enable some age hardening to take place. Fast solidification rates will give a finer grain size and hence better mechanical properties than slow solidification rates. Small weld beads therefore generally have better properties than large weld

beads and a higher resistance to hot cracking. In the root pass, however, a small cross-section weld bead may increase the risk as it will be required to carry the contractional stresses and restraint.

There is very little that can be done to improve the properties of the weld metal. Solid solution strengthening can be useful and the selection of the appropriate filler metal can significantly contribute to a high weld metal strength. As a general rule the weld metal will match the parent metal properties only when the parent metal itself is in either the as-cast or annealed condition. Where cold work has been used to increase the strength of the parent metal it is not practicable to match these by cold working the weld. The lower strength in the weld metal must therefore be accepted and compensated for in the design. With some of the precipitation-hardening alloys a post-weld ageing treatment can be carried out to increase the strength of the weld metal, provided that the weld metal contains those alloying elements which will give precipitation hardening as mentioned above. The effectiveness of this heat treatment will depend upon the filler metal composition and dilution. For example, a single pass AC-TIG weld in a 6061 series alloy made with a 4043 filler metal will give an ultimate tensile strength of around  $300\text{ N/mm}^2$  in the post-weld aged condition, a multi-pass MIG weld made with a 4043 filler will give approximately  $230\text{ N/mm}^2$ . Changing the 4043 filler to a 4643, which contains only 0.2% of magnesium, will improve the strength after post-weld ageing to match that of the auto-genous AC-TIG weld. This is a further example of the importance of the correct selection of filler metals and the control of consistency during welding of the aluminium alloys.

## 2.4.2 Heat affected zone

As mentioned earlier, alloys in the as-cast or annealed condition may be welded without any significant loss of strength in the HAZ, the strength of the weldment matching that of the parent metal. Where the alloy has had its strength enhanced by cold work or precipitation hardening then there may be a substantial loss of strength in the HAZ.

The cold worked alloys will experience a loss of strength due to recrystallisation in the HAZ. Recrystallisation begins to take place when the temperature in the HAZ exceeds  $200^\circ\text{C}$  and progressively increases with full annealing taking place over  $300^\circ\text{C}$  as illustrated in Fig. 2.17. This shows a 1XXX alloy cold worked to different amounts and heat treated at a range of temperatures, showing how the annealing heat treatment results in a major loss of strength. The result of this in practice is illustrated in Fig. 2.18 which shows a 5XXX alloy TIG welded.

A similar picture can be seen in the heat-treatable alloys. The situation here is somewhat more complex than with the work-hardened alloys but

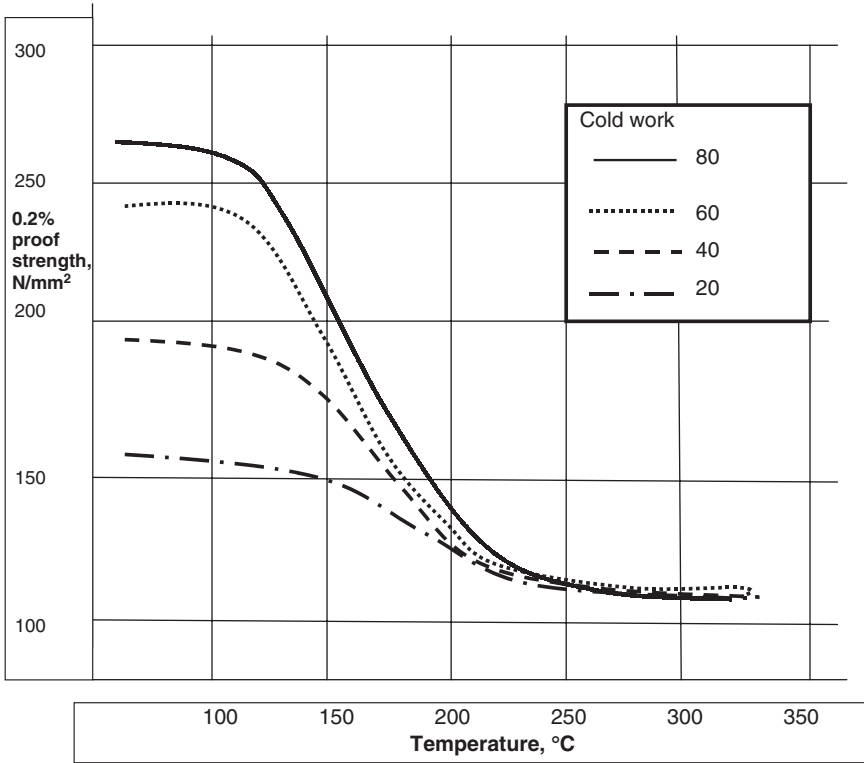

2.17 Effect of annealing temperature on cold work and strength.

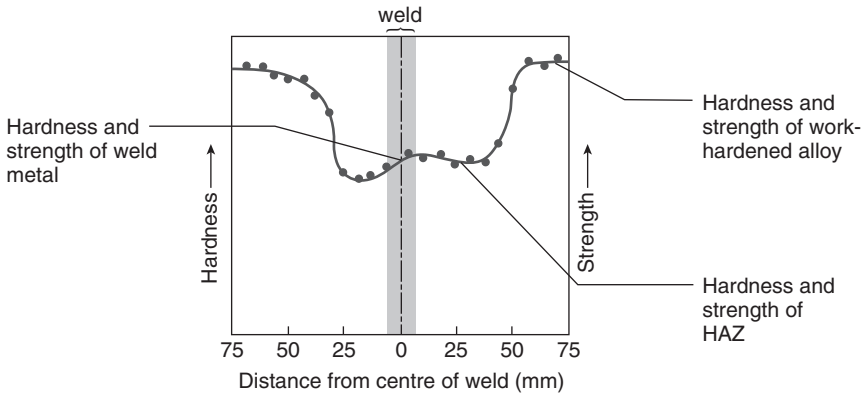

2.18 Effect of welding on strength in cold worked alloy.

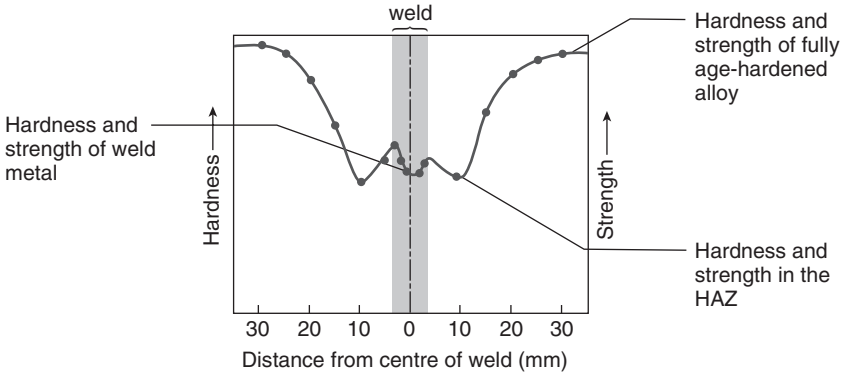

2.19 Effect of welding on 6061 T6 age-hardened alloy – as welded.

similar losses in tensile strength can be found. The loss is caused by a dissolution of the precipitates in the 2XXX series alloys and a coarsening or overageing of the precipitates in the 6XXX and 7XXX alloys. These effects are illustrated in Fig. 2.19. Greater detail on these effects for individual alloys can be found in Chapter 3.

One last comment is the potential for the loss of alloying elements from the weld pool that may result in a reduction in strength. It is true that some elements, mainly magnesium with its low boiling point and lithium which is highly reactive with oxygen, may be lost or oxidised during welding. There is, however, a dearth of information quantifying any effects, which suggests that it is not perceived as being a problem. Loss of magnesium is worst when MIG welding, resulting in the sooty deposit occasionally seen along the weld toes but in this case, and in the case of lithium, careful attention to gas shielding will minimise any problem.



### 3.1 Designation criteria

Aluminium alloys may be divided into two broad classes, cast and wrought products. These two classes can be further subdivided into families of alloys based on chemical composition and finally on *temper designation*. Temper designations are used to identify the *condition* of the alloy, in other words the amount of cold work the alloy has undergone or its heat treatment condition. There are a number of schemes available for identification of the alloy and its condition. In this book the numeric method adopted by the European Committee for Standardisation (CEN) will be used as standard. This system uses four digits to identify the wrought alloys and five digits to identify the cast alloys, and is broadly the same as the ISO and US numerical methods of identification where a four digit number identifies the unique alloy composition. This is in agreement with the recommendation made in the early 1970s for an International Designation System issued by the Aluminum Association in the USA. The chemical composition limits specified in the CEN specifications are identical with those registered with the Aluminum Association for the equivalent alloys. This should simplify the sourcing of alloys and remove the confusion that can surround the identification of specific grades. One perennial problem for the welding engineer is the use of superseded specification designations to identify alloy compositions. As an aid to identification a table of comparative specification designations is included as Appendices C and D.

### 3.2 Alloying elements

The principal alloying elements are copper, silicon, manganese, magnesium, lithium and zinc. Elements such as nickel, chromium, titanium, zirconium and scandium may be added in small amounts to achieve specific properties. Other elements may also be present in small amounts as unwanted impurities. These elements, known as tramp or residual elements, have no

beneficial effects on mechanical properties and the aluminium producers attempt to eliminate these from their products. The main effects of the alloying elements are as follows:

- Magnesium (Mg) increases strength through solid solution strengthening and improves work hardening ability.
- Manganese (Mn) increases strength through solid solution strengthening and improves work hardening ability.
- Copper (Cu) gives substantial increases in strength, permits precipitation hardening, reduces corrosion resistance, ductility and weldability.
- Silicon (Si) increases strength and ductility, in combination with magnesium produces precipitation hardening.
- Zinc (Zn) substantially increases strength, permits precipitation hardening, can cause stress corrosion.
- Iron (Fe) increases strength of pure aluminium, generally residual element.
- Chromium (Cr) increases stress corrosion resistance.
- Nickel (Ni) improves elevated temperature strength.
- Titanium (Ti) used as a grain-refining element, particularly in filler metals.
- Zirconium (Zr) used as a grain-refining element, particularly in filler metals.
- Lithium (Li) substantially increases strength and Young's modulus, provides precipitation hardening, decreases density.
- Scandium (Sc) substantially increases strength by age hardening, grain-refining element particularly in weld metal.
- Lead (Pb) and bismuth (Bi) assist chip formation in free machining alloys.

### 3.3 CEN designation system

#### 3.3.1 Alloy composition identification

A full listing of all of the British and European specifications dealing with any aspect of aluminium alloys, product forms, supply conditions and welding is given in Appendix A at the end of the book.

There are two methods in the CEN system for identifying aluminium alloys, one based on the numerical designation adopted by ISO and as recommended by the Aluminum Association, the other on the basis of chemical composition. The details of the European system are contained in the specification BS EN 573. This is divided into four parts as follows:

- Part 1 Numerical Designation System.
- Part 2 Chemical Symbol Based Designation System.

- Part 3 Writing Rules for Chemical Composition.
- Part 4 Form of Products.

In the European system the prefix 'AB' denotes ingots for remelting, 'AC' denotes a cast product, 'AM' a cast master alloy, the prefix 'AW' a wrought product. For the wrought alloys this is followed by the four digit number which uniquely identifies the alloy. The first digit indicates the main alloying element, with numbers 1 to 9 being used as follows:

- AW 1XXX – commercially pure aluminium.
- AW 2XXX – aluminium–copper alloys.
- AW 3XXX – aluminium–manganese alloys.
- AW 4XXX – aluminium–silicon alloys.
- AW 5XXX – aluminium–magnesium alloys.
- AW 6XXX – aluminium–magnesium–silicon alloys.
- AW 7XXX – aluminium–zinc–magnesium alloys.
- AW 8XXX – other elements e.g. lithium, iron.
- AW 9XXX – no alloy groups assigned.

Except in the case of the commercially pure aluminium alloys, the last three digits are purely arbitrary and simply identify the specific alloy. In the case of the pure aluminium, however, the last two digits indicate the minimum percentage aluminium in the product to the nearest 0.01%, e.g. AW-1098-99.98% Al, AW-1090-99.90% Al. The second digit gives the degree of control on impurities: a zero indicates natural impurity limits, a figure between 1 and 9 that there is special control of one or more of the individual impurities or alloying elements.

There are a total of 36 separate compositions of casting alloys, divided into 11 subsections as follows. It is worth mentioning that 29 of the alloys are based on the Al-Si system.

- AC 2 1 XXX – Al Cu.
- AC 4 1 XXX – Al SiMgTi.
- AC 4 2 XXX – Al Si7Mg.
- AC 4 3 XXX – Al Si10Mg.
- AC 4 4 XXX – Al Si.
- AC 4 5 XXX – Al Si5Cu.
- AC 4 6 XXX – Al Si9Cu.
- AC 4 7 XXX – Al Si(Cu).
- AC 4 8 XXX – Al SiCuNiMg.
- AC 5 1 XXX – Al Mg.
- AC 7 1 XXX – Al ZnMg.

As with the wrought alloys the third and fourth digits identify the specific alloy in the group and are arbitrary.

Master alloys, which will not concern the shop-floor welding engineer, are identified with the prefix 'AM' followed by the number '9', the second and third figures are the atomic number of the main alloying element, e.g. 14 for silicon, 29 for copper, the last two digits being chronological and issued in the order of registration of the alloy. For example, an aluminium–silicon master alloy could carry the designation AM 91404, identifying the alloy as being the fourth Al-Si alloy to be registered.

### 3.3.2 Temper designations

The mechanical properties of the alloys are affected not only by their chemical composition but also by their condition, e.g. annealed, cold worked, precipitation hardened. It is obviously important that this condition is clearly and unequivocally identified for both the designer and the welding engineer. To do this CEN has developed a system of suffixes that identify the amount of strain hardening the alloy has undergone or its heat treatment condition. There are five basic designations identified by a single letter which may be followed by one or more numbers to identify the precise condition.

The basic designations are as follows:

- F – as fabricated. This applies to wrought products where there is no control of the amount of strain hardening or the thermal treatments. There are no mechanical properties specified for this condition.
- O – annealed. This is for products that are annealed to produce the lowest strength. There may be a suffix to indicate the specific heat treatment.
- H – strain hardened (cold worked). The letter 'H' is always followed by at least two digits to identify the amount of cold work and any heat treatments that have been carried out to achieve the required mechanical properties.
- W – solution heat treated. This is applied to alloys which precipitation harden at room temperature (natural ageing) after a solution heat treatment. It is followed by a time indicating the natural ageing period, e.g. W 1 h.
- T – thermally treated. This identifies the alloys that are aged to produce a stable condition. The 'T' is always followed by one or more numbers to identify the specific heat treatment.

The first digit after 'H' identifies the basic condition:

- H1 – strain hardened only.
- H2 – strain hardened and partially annealed. This applies to the alloys that are hardened more than is required and that are then annealed at

a low temperature to soften them to the required degree of hardness and strength.

- H3 – strain hardened and stabilised. Stabilisation is a low-temperature heat treatment applied during or on completion of fabrication. This improves ductility and stabilises the properties of those strain-hardened alloys that soften with time.
- H4 – strain hardened and painted. This is for alloys that may be subjected to low-temperature heat treatment as part of a paint baking or adhesive curing operation.

The second digit after ‘H’ indicates the amount of strain hardening in the alloy. H18 is strain hardened only and in the most heavily cold worked condition. It is therefore the hardest and highest strength condition. Ductility will be very low and further cold work may cause the component to crack. Intermediate conditions are identified by the numbers 1 to 7 and are based on the strength relative to that of the annealed alloy, O condition and the H18 condition, e.g. an H14 alloy will have a strength halfway between the annealed and fully hard condition, H12 halfway between O and H14. There is an H9 condition in which the ultimate tensile strength exceeds that of the H8 condition by a minimum of  $10\text{N/mm}^2$ .

The third digit after ‘H’ is not mandatory and is used when the alloy requires special control to achieve the specific temper identified by the second digit or when some other characteristic of the alloy is affected. Examples of such characteristics are exfoliation corrosion resistance, seam welded tube or additional working after the final temper has been achieved, e.g. by embossing.

The ‘T’ designations are applied to those alloys that are age hardened, the first digit identifying the basic heat treatment:

- T1 – cooled from an elevated temperature-shaping treatment and naturally aged.
- T2 – cooled from an elevated temperature-shaping process, cold worked and naturally aged.
- T3 – solution heat treated, cold worked and naturally aged.
- T4 – solution heat treated and naturally aged.
- T5 – cooled from an elevated temperature-shaping process and artificially aged.
- T6 – solution heat treated and artificially aged.
- T7 – solution heat treated and overaged or stabilised.
- T8 – solution heat treated, cold worked and artificially aged.
- T9 – solution heat treated, artificially aged and cold worked.

More digits may be added to the designation to indicate variations in heat treatments or cold work. For example, TX51, 510, 511, 52 or 54 all indicate

those alloys that are stress relieved after heat treatment by some form of cold working such as stretching or restriking cold in the finish die. These additional digits are also used to indicate the temper condition of those alloys designated 'W'.

The T7, artificially aged, temper designation may be supplemented by a second digit to indicate if the alloy is overaged and by how much. Other numbers are used to identify underaged conditions and increasing degrees of cold work etc.

The full details of these designations are contained in the specification EN 515 'Aluminium and Aluminium Alloys – Wrought Products – Temper Designations'.

### 3.4 Specific alloy metallurgy

#### 3.4.1 Non-heat treatable alloys

##### 3.4.1.1 Pure aluminium (1XXX series)

The principal impurities in 'pure' aluminium are silicon and iron, residual elements remaining from the smelting process. Copper, manganese and zinc may also be present in small amounts. The maximum impurity levels vary with the specified purity, e.g. 1098 (Al99.98) contains a maximum impurity content of 0.02%, comprising 0.010% Si max., 0.006% Fe max., 0.0035% Cu max. and 0.015% Zn max. The 1050 (Al99.5) alloy contains a maximum of 0.05% of impurities. In the high-purity grades of these alloys the impurities are in such low concentrations that they are completely dissolved. From the welding viewpoint the alloys can be regarded as having no freezing range and a single phase microstructure which is unaffected by the heat of welding. The less pure alloys such as 1200 (Al99.0) can dissolve only small amounts of the impurity elements and, as the metal freezes, most of the iron comes out of solution to form the intermetallic compound  $\text{FeAl}_3$ . When silicon is present in more than trace quantities, a *ternary* or three-element compound, Al-Fe-Si phase, is formed. With higher silicon contents free primary silicon is formed. All of these phases contribute to an increase in strength, attributed to slight solution hardening and by a dispersion of the phases.

The effects of welding on the structure of a fusion welded butt joint in an annealed low-purity aluminium such as 1200 is to produce three distinct zones. The unaffected parent material will have a fine-grained structure of wrought metal with finely dispersed particles of Fe-Al-Si. The heat affected zones show no significant change in microstructure except close to the fusion boundary where partial melting of the low melting point constituents along the grain boundaries occurs, leaving minute intergranular shrinkage

cavities that result in a slight loss of strength. There will also be a loss of strength in the cold work alloys where the structure has been annealed and softened. The weld metal has an as-cast structure. When the filler metal has the same nominal composition as the parent metal the low melting point constituents such as Fe-Al-Si are the last to solidify and will be located at the grain boundaries.

#### 3.4.1.2 Aluminium–manganese alloys (3XXX series)

When iron is present as an impurity the solubility of manganese in aluminium is very low. The rate of cooling from casting or welding is sufficiently rapid for some manganese to be left in supersaturated solution. Further processing to provide a wrought product causes the manganese to precipitate as  $\text{FeMnAl}_6$ , this precipitate giving an increase in strength due to dispersion hardening. Any uncombined iron and silicon impurities may be present as an insoluble Al-Fe-Mn-Si phase.

The weld zones are similar to those seen in pure aluminium, the only major difference being the composition of the precipitates. The heat of welding has the same effect on the structure as on pure aluminium, with the precipitates arranged along the grain boundaries and a loss of strength in the annealed regions of cold worked alloys.

The 3103 (AlMn1) alloy is more hot short (see Section 2.5) than pure aluminium, despite having a similar freezing range. In practice, however, hot cracking is rarely encountered. Those alloys containing copper (alloy 3003) or magnesium (alloys 3004, 3005 and 3105) are more sensitive to hot cracking. Weld cracking may be sometimes encountered when autogenous welding but this is easily prevented by the use of an appropriate filler metal composition.

#### 3.4.1.3 Aluminium–silicon alloys (4XXX series)

The aluminium silicon alloys form a binary eutectic at 11.7% silicon with a melting point of 577°C, the two phases being solid solutions of silicon in aluminium, 0.8% maximum at room temperature, and aluminium in silicon. There are no intermetallic compounds. Sodium may be added in small amounts to refine the eutectic and increase the strength by improved dispersion hardening. Iron, even in small amounts, can seriously degrade toughness although manganese may be added to reduce this effect.

The 4XXX series has very high fluidity and is extensively used for casting purposes, often being alloyed with copper and magnesium to provide some degree of precipitation hardening and with nickel to improve high temperature properties. Because of its high fluidity and low sensitivity to hot shortness it is commonly used as a weld filler metal.

### 3.4.1.4 Aluminium–magnesium alloys (5XXX series)

Up to about 5% magnesium can be dissolved in aluminium to provide a substantial amount of solid solution strengthening: the higher the magnesium content, the higher the strength. The amount of magnesium that can be dissolved under equilibrium conditions at ambient temperature is only some 1.4%, meaning that there is always a tendency for the magnesium to come out of solution when the higher magnesium content alloys are heated and slowly cooled. This reaction is very sluggish and welding processes do not cause any appreciable change in the microstructure except in the cold worked alloys where mechanical strength will be reduced.

The standard aluminium–magnesium alloys have iron and silicon as impurities and deliberate additions of around 0.4–0.7% of manganese to increase strength further, mainly by dispersion hardening. Chromium may be added in place of or in addition to manganese to achieve the same strength increase, 0.2% chromium being equivalent to 0.4% manganese. The iron forms  $\text{FeMnAl}_6$ ; the silicon combines with magnesium to form magnesium silicide,  $\text{Mg}_2\text{Si}$ , most of which is insoluble.

The magnesium alloys may all have their microstructure changed by the heat of welding. The microstructure of a butt weld in 5083 ( $\text{AlMg}_4.5\text{Mn}_0.7$ ) in the annealed condition, welded with a 5356 filler shows the following features. The parent metal will have a fine-grained structure composed of a matrix of a solid solution of magnesium in aluminium, dispersion strengthened with a fine precipitate of the compound  $\text{Mg}_2\text{Al}_3$  together with coarser particles of Al-Fe-Si-Mn. In the HAZ where the temperature has been raised to around 250 °C further  $\text{Mg}_2\text{Al}_3$  will be formed which may begin to coalesce and coarsen. Where temperatures begin to approach 400 °C some of the  $\text{Mg}_2\text{Al}_3$  will be redissolved and closer to the weld, where temperatures are above 560 °C, partial melting occurs, causing some shrinkage cavitation. The weld metal is an as-cast structure of a supersaturated solution of magnesium in aluminium with particles of the insoluble intermetallics such as  $\text{Mg}_2\text{Si}$ . The cooling rates of the weld metal are generally fast enough to prevent the precipitation of  $\text{Mg}_2\text{Al}_3$ .

The strength of aluminium–magnesium weld metal is generally close to that of the annealed wrought parent metal of the same composition and it is not difficult to achieve joint strengths at least equal to the annealed condition. Butt joints in parent metal with more than 4% magnesium sometimes show joint strengths less than that of the annealed parent alloy. In MIG welding this may be due to the loss of magnesium in the arc and it may be advisable to use a more highly alloyed filler such as 5556 ( $\text{AlMg}_5.2\text{Cr}$ ).

5083 is normally welded with a filler metal of similar composition because the higher magnesium contents increase the risk of stress corrosion



cracking. A continuous network of  $Mg_2Al_3$  along the grain boundaries may make the alloy sensitive to stress corrosion in the form of intergranular corrosion. The alloy can be sensitised by prolonged exposure to temperatures above  $80^\circ C$ . In service at or above this temperature in mildly corrosive environments the magnesium content should be limited to a maximum of 3%. Alloys for service in these conditions are generally of the 5251 or 5454 type, welded with a 5554 (AlMg3) filler metal. In multi-pass double-sided welds a 5% Mg filler may be used for the root passes to reduce the risk of hot cracking, followed by 5554 filler for the filling and capping passes.

The 5XXX alloys containing between 1% and 2.5% magnesium may be susceptible to hot cracking if welded autogenously or with filler metal of a matching composition. The solution is to use more highly alloyed filler metal containing more than 3.5% magnesium.

### 3.4.2 Heat-treatable alloys

#### 3.4.2.1 Aluminium–copper alloys (2XXX series)

The aluminium–copper alloys are composed of a solid solution of copper in aluminium which gives an increase in strength, but the bulk of the strength increase is caused by the formation of a precipitate of copper aluminate  $CuAl_2$ . To gain the full benefits of this precipitate it should be present as a finely and evenly distributed submicroscopic precipitate within the grains, achieved by solution treatment followed by a carefully controlled ageing heat treatment. In the annealed condition a coarse precipitate forms along the grain boundaries and in the overaged condition the submicroscopic precipitates coarsen. In both cases the strength of the alloy is less than that of the correctly aged condition.

The early aluminium–copper alloys contained some 2–4% of copper. This composition resulted in the alloys being extremely sensitive to hot shortness, so much so that for many years the 2XXX were said to be unweldable. Increasing the amount of copper, however, to 6% or more, markedly improved weldability owing to the large amounts of eutectic available to back-fill hot cracks as they formed. The limit of solid solubility of copper in aluminium is 5.8% at  $548^\circ C$ ; at ambient this copper is present as a saturated solid solution with particles of the hardening phase copper aluminate,  $CuAl_2$ , within the grains as a fine or coarse precipitate or at the grain boundaries.

The effect of welding on the age-hardened structure is to re-dissolve the precipitates, giving up to a 50% loss in ultimate tensile strength in a T6 condition alloy. The weldable alloy 2219 (AlCu6) can recover some of this strength loss by artificial ageing but this is usually accompanied by a reduction in ductility. The best results in this alloy are obtained by a full solution

treatment and ageing after welding, not often possible in a fully fabricated structure. The less weldable alloy 2014 (AlZnMgCu) may also be heat treated to recover some tensile strength but the improvement is not as great as in 2219 (AlCu6) and may exhibit an even greater reduction in ductility.

Filler metals of similar composition such as 2319 (AlCu6) are available and weld metal strengths can therefore be matched with the properties in the HAZ.

#### 3.4.2.2 *Aluminium–magnesium–silicon alloys (6XXX series)*

The hardening constituent in 6XXX series alloys is magnesium silicide  $Mg_2Si$ . These alloys contain small amounts of silicon and magnesium, typically less than 1% each, and may be further alloyed with equally small amounts of manganese, copper, zinc and chromium. The alloys are sensitive to weld metal cracking, particularly when the weld metal is rich in parent metal such as in the root pass of the weld. Fortunately the cracking can be readily prevented by the use of filler metals containing higher proportions of silicon such as 4043 or, with a slightly increased risk of hot cracking, the higher magnesium alloys such as 5356.

With these heat-treatable alloys the changes in the structure and mechanical properties, briefly discussed in Chapter 2, are complex and strongly dependent on the welding conditions employed. Welding without filler metal or with filler metal of parent metal composition is rarely practised because of the risk of weld metal hot cracking. A weld metal with a composition close to that of the parent metal may age-harden naturally or may be artificially aged to achieve a strength approaching, but never matching, that of the aged parent metal.

In the overheated zone in the HAZ closest to the fusion line, partial melting of the grain boundaries will have taken place. Temperatures have been high enough and cooling rates sufficiently fast that solution treatment has taken place, enabling some ageing to occur after welding. Adjacent to this is the partially solution-treated zone where some of the precipitates have been taken into solution, enabling some post-weld hardening to occur, but those not dissolved will have been coarsened. Outside this will be the overaged zone where precipitate coarsening has taken place and there has been a large drop in strength.

The strength losses in the 6000 alloys are less in the naturally aged metal than in the artificially aged alloys. The strength of the weld and HAZ in the artificially aged condition generally drop to match that of the naturally aged alloy with a narrow solution-treated zone either side of the weld and an overaged zone beyond this, which is weaker than the T6 condition. With controlled low-heat input welding procedures the strength of the weldment

will not drop to that of an annealed structure but will be close to that of the T4 condition.

### 3.4.2.3 Aluminium–zinc–magnesium alloys (7XXX series)

7XXX series alloys may, from a welding point of view, be conveniently divided into two groups. The first group is the high-strength alloys containing more than 1% copper, normally used in the aerospace industry and joined by non-welding methods. The second group is the medium strength alloys which have been developed for welding.

Aluminium and zinc form a eutectic containing solid solutions of 83% zinc in aluminium and 1.14% aluminium in zinc. The addition of magnesium complicates the situation with additional ternary eutectics and complex intermetallics being formed, these intermetallics providing dispersion hardening and precipitates of composition  $MgZn_2$ . Copper provides further precipitation hardening, forming  $CuAl_2$  and an intermetallic of the copper–zinc system.

Welding of the hardened high-strength alloys results in a major loss of strength, the high-strength alloys such as 7022 (AlZn5Mg3Cu) or 7075 (AlZn5.5MgCu1.6) in particular suffering a considerable reduction in strength. Although almost all of this strength loss can be recovered by a full heat treatment, the loss in ductility is so great that brittle failure is a real possibility. The alloys are also very prone to hot cracking and the combination of these adverse features is such that the high-strength alloys are rarely welded. Joining techniques such as riveting or adhesive bonding are often used to avoid these problems.

The lower-strength non-copper-containing alloys such as 7017 (AlZn5Mg2.5Mn0.7), 7020 (AlZn4.5Mg1) and 7039 (AlZn4Mg2.5Mn0.7) are more readily weldable. The response of these alloys is very similar to that of the 6XXX series, with a loss of strength in the heat affected zones, some of which can be recovered by suitable heat treatment. The alloys will age naturally but it may take up to 30 days for ageing to proceed to completion. The strength loss in the 7XXX alloys is less than that in the 6XXX series and this, coupled with the natural ageing characteristic, makes this alloy a popular choice for structural applications where on-site repair and maintenance work may be required.

One problem peculiar to the 7XXX series is that the zinc rapidly forms an oxide during welding, affecting the surface tension of the weld pool and increasing the risk of lack of fusion defects. This requires the use of welding procedures in which the welding current is some 10–15% higher than would be used for a 5XXX alloy. It has also been found to be beneficial to use a shorter arc than normal so that metal transfer is almost in the globular range.

#### 3.4.2.4 *Unassigned (or other alloys) (8XXX series)*

The 8XXX series is used to identify those alloys that do not fit conveniently into any of the other groups, such as 8001 (Al-Ni-Fe) and 8020 (Al-Sn). However, contained within this 8XXX group are the aluminium–lithium (Al-Li) alloys, a relatively new family that gives substantial weight savings of up to 15% and a higher Young's modulus compared with some of the other high-strength alloys. Each 1% of lithium added results in an approximate 3% reduction in weight. These advantages mean that significant weight savings can be achieved in the design of aerospace structures and that the very high-strength unweldable alloys, such as those in the 2XXX series, may be replaced by the weldable, lighter Al-Li alloys.

The Al-Li alloys generally contain some 2–3% of lithium and small amounts of copper and magnesium. They are fully heat treatable, with a number of different precipitates, the principal one being  $\text{Al}_3\text{Li}$ . Typical of these alloys are 8090 ( $\text{AlLi}_2.5\text{Cu}_1.5\text{Mg}_0.7\text{Zr}$ ) and 8091 ( $\text{AlLi}_2.6\text{Cu}_1.9\text{Mg}_0.8\text{Zr}$ ). Lithium has a great affinity for oxygen and this reactivity requires great care to be taken during any process that involves heating the alloy. These processes comprise melting, casting, high-temperature heat treatment and welding. Failure to remove the oxidised layer will result in gross porosity – some 0.2 mm should be machined off to be certain of complete removal. It may also be necessary to purge the back face of the weld with an inert gas to prevent oxidation and porosity. As with the 7XXX alloys the Al-Li alloys have a similar response to the heat of welding, losing strength in the HAZ, although a post-weld artificial ageing treatment can restore a large proportion of this strength.

A further family of alloys that may fall into this group once they have been assigned a designation are those containing scandium. These are new alloys, still to a great extent in the development phase. Scandium is a rare earth element that has been found to be highly effective in increasing strength by age hardening and by grain refinement, the latter being particularly useful in weld metal. Scandium is likely to be used in conjunction with other alloying elements such as zirconium, magnesium, zinc or lithium where tensile strengths of over  $600\text{N/mm}^2$  have been achieved in laboratory trials.

### 3.5 Filler metal selection

Filler metal specifications are to be found in BS 2019 Part 4, although this will be replaced in the near future by a CEN specification. The BS specification lists 11 filler metal types in the 1XXX, 3XXX, 4XXX and 5XXX series and details the delivery conditions. BS 2901 does not include any filler metals capable of being age hardened. The American Welding Society has

Table 3.1 General guidance on filler metal selection

Parent metal	Al-Si Castings	Al-Mg Castings	1XXX	2XXX	3XXX	4XXX	5XXX	6XXX	7XXX
Al-Si Castings	<b>4XXX</b>	NR	4XXX	NR	4XXX	4XXX	NR	4XXX	NR
	<b>NS</b>	NR	NS	NR	NS	NS	NR	NS	NR
	<b>NS</b>	NR	NS	NR	NS	NS	NR	NS	NR
Al-Mg Castings	NR	<b>5XXX</b>	5XXX	NR	5XXX	NR	5XXX	5XXX	5XXX
	NR	<b>NS</b>	NS	NR	3XXX	NR	NS	NS	NS
	NR	<b>NS</b>	NS	NR	NS	NR	NS	NS	NS
1XXX	4XXX	5XXX	<b>4XXX</b>	NR	4XXX	4XXX	5XXX	4XXX	5XXX
	NS	NS	<b>1XXX</b>	NS	3XXX	1XXX	NS	NS	NS
	NS	NS	<b>NS</b>	4047	NS	NS	NS	NS	NS
2XXX	NR	NR	NR	<b>NR</b>	NR	NR	NR	NR	NR
	NR	NR	NR	<b>NR</b>	NR	NR	NR	NR	NR
	NR	NR	4047	<b>4047</b>	4047	4047	NR	4047	NR
3XXX	4XXX	5XXX	4XXX	NR	<b>4XXX</b>	4XXX	5XXX	5XXX	5XXX
	NS	3XXX	3XXX	NR	<b>3XXX</b>	3XXX	NS	NS	NS
	NS	NS	NS	4047	<b>NS</b>	NS	NS	NS	NS
4XXX	4XXX	NR	4XXX	NR	4XXX	<b>4XXX</b>	NR	5XXX	5XXX
	NS	NR	1XXX	NR	3XXX	<b>NS</b>	NR	4XXX	4XXX
	NS	NR	NS	4047	NS	<b>NS</b>	NR	NS	NS
5XXX	NR	5XXX	5XXX	NR	5XXX	NR	<b>5XXX</b>	5XXX	5XXX
	NR	NS	NS	NR	NS	NR	<b>NS</b>	NS	NS
	NR	NS	NS	NR	NS	NR	<b>NS</b>	NS	NS
6XXX	4XXX	5XXX	4XXX	NR	5XXX	5XXX	5XXX	<b>5XXX</b>	5XXX
	NS	NS	NS	NR	NS	4XXX	NS	<b>NS</b>	NS
	NS	NS	NS	4047	NS	NS	NS	<b>4XXX</b>	NS
7XXX	NR	5XXX	5XXX	NR	5XXX	5XXX	5XXX	5XXX	<b>5XXX</b>
	NR	NS	NS	NR	NS	4XXX	NS	NS	<b>NS</b>
	NR	NS	NS	NR	NS	NS	NS	NS	<b>NS</b>

*Table 3.2* Guidance on filler metal selection – dissimilar metal joints for specific alloys

Parent metal	1050 1080 1200	2219	3103 3105	5005 5083 5251 5454	6061 6063 6082	7005 7019 7020 7039	8090
8090				5556			<b>5556</b>
7039	5556		5556	5356	5556	<b>5556</b>	
7019	5356		5356		5356	<b>5356</b>	
7020	5183		5183		5183	<b>5183</b>	
7005						<b>5039</b>	
6061	5356		4043	5356	<b>5556</b>		
6063	NS		5356		<b>5356</b>		
6082	4043				<b>5183</b>		
5454	5356		5356	<b>5356</b>			
5251	5356		5356	<b>5056</b>			
5083	5356		5356				
5005	5356						
3103	5356	2319	<b>5356</b>	5356	5356	5556	5556
3105		NS	<b>4043</b>		5056	5356	
	4043	4043					
2219	2319 4043	<b>2319</b>					
1050	<b>4043</b>	2319					
1080	<b>1050</b>	4043					
1200	<b>1080</b>						

published a similar specification, AWS A5.10 ‘Specification for Bare Aluminium and Aluminium Alloy Welding Electrodes and Rods’, which fulfils a similar role. This specification includes 15 separate filler metal compositions, comprising alloys in the 1XXX, 2XXX, 4XXX and 5XXX series. In addition there are five age-hardening filler metals designed for use in the welding of castings. AWS A5.10 also includes delivery conditions and the testing requirements for usability and soundness.

As mentioned earlier, filler metal selection is crucial to producing crack-free, optimum strength welded joints but there are other considerations that may need to be included when making the choice. Unlike selecting consumables for welding steel, where the composition of the filler metal generally matches that of the parent metal with respect to composition, mechanical properties, corrosion resistance and appearance, aluminium alloys are often welded with filler metals that do not match the parent metal in some or all of these properties. This presents the engineer with some problems when it comes to deciding on the optimum filler metal composition. In addition to strength and crack resistance the choice may also need to include colour match, corrosion resistance, response to anodising and

*Table 3.3* Filler metal selection to achieve specific properties for the commoner structural alloys

Base material	Highest strength	Best ductility	Salt water corrosion resistance	Least cracking tendency	Best for anodising
1100	4043	1050	1050	4043	1100
2219	2319	2319	2319	2319	2319
3103	4043	1050	1050	4043	1050
5052	5356	5356	5554	5356	5356
5083	5183	5356	5183	5356	5356
5086	5356	5356	5183	5356	5356
5454	5356	5554	5554	5356	5554
5456	5556	5356	5556	5356	5556
6061	5356	5356	4043	4043	5654
6063	5356	5356	4043	4043	6356
6082	4043	4043	4043	4043	4043
7005	5556	5356	5356	5356	5356
7039	5556	5356	5356	5356	5356

creep strength. Guidance on suitable fillers can be found in Table 3.1, for specific alloys, in Table 3.2 and to achieve specific properties in some of the commoner structural alloys in Table 3.3. In Table 3.1 there are three recommendations based on the best strength, the upper figure; the highest crack resistance, the middle figure; and an acceptable alternative, the lower figure. Note that the alloys are arranged in families – for a recommendation on filler metal read directly across and down from the alloys of interest.

There are a number of specific points to be made to amplify the guidance given in Tables 3.1–3.3:

- When welding alloys containing more than 2% magnesium avoid the use of fillers containing silicon as the intermetallic compound magnesium silicide,  $Mg_3Si$ , is formed. This embrittles the joint and can lead to failure in joints that are dynamically loaded. The converse is also true, that  $Mg_3Si$  will be formed when welding alloys containing more than 2% silicon with 5XXX fillers.
- 5XXX filler metals with more than 5% Mg should be avoided if the service temperature exceeds  $65^\circ C$  as  $Al_2Mg$  is formed, which makes the alloy susceptible to stress corrosion. Filler metals such as 5454 or 5554 containing less than 3% Mg should be used.
- High-purity 5654 is preferred for the welding of high-purity aluminium in hydrogen peroxide service.
- 4643 may be used to weld the 6XXX alloys as the small amount of magnesium improves the response to solution treatment.

- The pure aluminium 1XXX alloys are very soft and wire feeding problems can be experienced.
- Low magnesium (<2%) 5XXX alloys such as 5251 may suffer hot cracking if matching composition fillers are used. Use Al-Mg5 type instead.
- When welding the 7XXX alloys 5039 filler metal may give more effective age hardening in low-dilution applications.
- 6XXX alloys exhibit solidification cracking if welded autogenously.
- Titanium and zirconium are sometimes added to filler metals to reduce the risk of weld metal hot cracking by means of grain refinement.
- 4047 may be used to prevent weld metal cracking in joints involving high dilution or restraint but remember the first point above.
- The 2XXX series of copper containing alloys were generally regarded as unweldable until the higher (>4%) copper alloys such as 2219 became available. If it is necessary to weld the lower copper-containing alloys then 4047 is the best choice as a filler metal.



## 4.1 Introduction

The need for degreasing and oxide removal has been covered in Chapter 2. This chapter will review both the handling and storage of aluminium and the options available for cutting, machining and pickling and cleaning of the alloys prior to welding. There are a number of thermal processes available to the fabricator for either cutting or weld preparing, as discussed in this chapter. One process that is not available for the cutting of aluminium, however, is the oxy-gas process used so widely to cut the carbon and low-alloy steels. Instead, arc or power beam processes or machining must be used to provide the correct edge preparations for welding.

Correct and accurate edge preparations are essential for the production of sound, defect-free welds in aluminium. Edge preparations are required to achieve full penetration to the root of the joint, to enable the correct analysis of weld metal to be achieved, to assist the welder to produce defect-free joints and to do this at an acceptable cost. The design of edge preparations for specific welding processes will be dealt with in the chapters dealing with the individual processes.

## 4.2 Storage and handling

Good handling practices are required if aluminium components are to be supplied to the customer in an unmarked condition. Aluminium is a relatively soft material and is easily scored or dented by clumsy handling or the use of inappropriate lifting equipment. Over-centre edge clamps, commonly used on steels, can score plate edges and steel chains can produce scratches and dents. A solution to marking by clamps is to face the jaws with a soft material – wood or polythene blocks are excellent as packing materials. Lifting should be carried out with nylon ropes or webbing straps. Remember that these softer materials are far more easily damaged than steel and more regular maintenance of any lifting equipment will be necessary. Hard

particles can also become embedded in the packing or lifting strops, resulting in marking of the components.

Storage is important if the surface condition of the aluminium is not to suffer. Ideally, items should be stored indoors in a dry, clean and well-ventilated storage area. Storing plates flat may give rise to water staining from condensation collecting on the surface. This can be particularly damaging if the plates are stacked directly one on top of another, when a thick layer of hydrated oxide can rapidly form at the interface. Plates should always be separated in storage and ideally stacked on edge to provide good air circulation. This reduces the risk of accumulating water and dirt on the flat surfaces and prevents other items being stored on top. It also assists in reducing the risk of scratches from dragging plates off the stack.

### 4.3 Plasma-arc cutting

Plasma-arc may be used for either cutting or welding and is the most widely used thermal process for cutting of aluminium alloys in manual, mechanised or fully automated modes (Fig. 4.1). In the latter case cuts of excellent quality can be achieved in material of up to 250mm thickness at high cutting speeds.

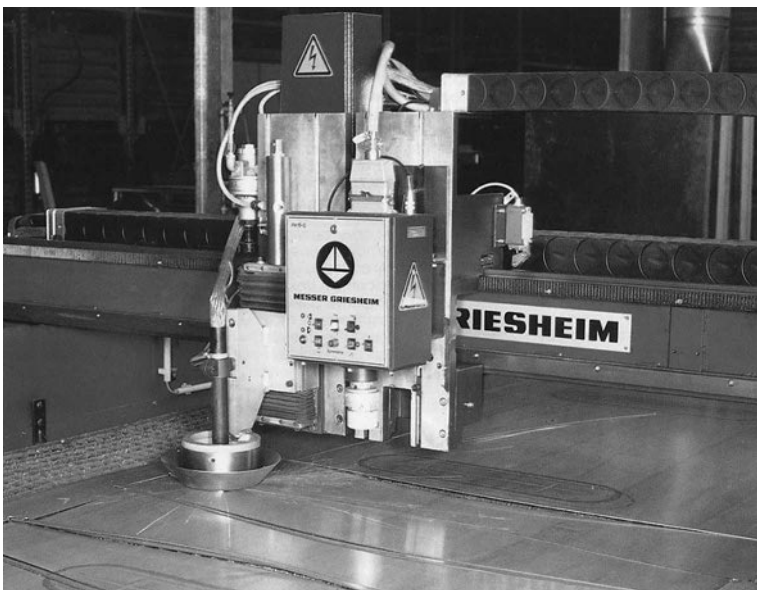

4.1 Fully programmable CNC plasma-jet cutting system. Courtesy of Messer Griesheim.

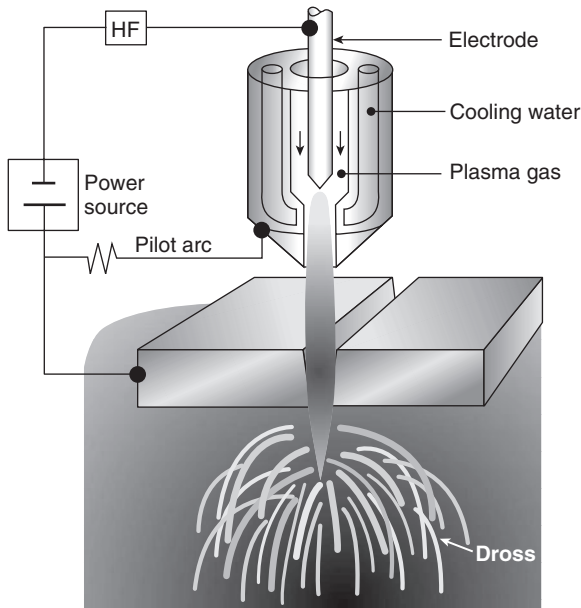

4.2 Schematic illustrating the principles of plasma-jet cutting.  
Courtesy of TWI Ltd.

Plasma-arc utilises a specially designed torch in which a tungsten electrode is recessed inside a water-cooled copper annulus, through which is passed the plasma gas. An arc is struck between the electrode and the work-piece, *transferred arc plasma-arc*, or between the electrode and the annulus, *non-transferred arc plasma-arc*. Transferred arc plasma-arc is used for cutting purposes (Fig. 4.2). The plasma gas is heated by the arc to an extremely high temperature within the annulus and is ionised – it becomes a *plasma*. At the same time it expands in volume due to the high temperature and, being forced through the constriction of the nozzle, reaches very high velocity. The heat for welding and cutting is therefore provided by a ‘flame’ or plasma jet of high-velocity gas at temperatures of up to 15000 °C, which has the characteristics of being highly concentrated, virtually insensitive to stand-off distance and extremely stiff. This makes it an ideal candidate for cutting purposes.

The cut is made by the plasma jet piercing the component to be cut to form a *keyhole*, a hole that penetrates completely through the item. This is filled with the gas and is surrounded by molten metal. The force of the plasma jet alone may be sufficient to remove this molten metal but with thicker material a secondary cutting gas may be required to assist in metal removal. This secondary gas is supplied via a series of holes around the plasma nozzle designed to blow away the molten metal to give a clean,

high-quality and narrow cut. Plasma gases include air, argon, argon–hydrogen, nitrogen and carbon dioxide. Cutting can be performed manually or mechanised with higher cutting speeds being achievable with mechanised and automated systems.

A plasma cut edge is generally not completely square. The top edge of the cut may be rounded by some 1 or 2 mm, particularly if the cutting energy is high for the thickness of plate being cut or when high-speed cutting of thin material is being carried out. The plasma jet also tends to remove more metal from the upper part of the component than the lower part, resulting in a cut wider at the top than the bottom with non-parallel sides. This ‘bevel’ angle may be between  $3^\circ$  and  $6^\circ$ . The cut surface may also be rough. The quality of the cut is affected by gas type, gas flow rate, cutting speed and operating voltage. High gas flow rates and high voltages will improve the squareness of the cut and mechanised cutting will give an improved appearance.

Arc cutting produces a HAZ and may cause melting at the grain boundaries. This results in micro-cracking, primarily of the heat-treatable alloys – the 7000 series being particularly sensitive. As the thickness increases, the likelihood of such cracking also increases. For this reason it is advisable to machine back the plasma cut edges by about 3 mm, particularly if the component is to be used in a dynamic loading environment.

The composition of the gas for plasma cutting depends on the required quality of the cut, the thickness of the metal to be cut and the cost of the gas. Air is the cheapest option and single gas systems utilising air and a hafnium electrode have been developed for the cutting of materials up to approximately 6 mm in thickness (Fig. 4.3).

Above this thickness nitrogen, carbon dioxide, argon–hydrogen or mixtures of these gases may be used. For the thicker materials over, say,

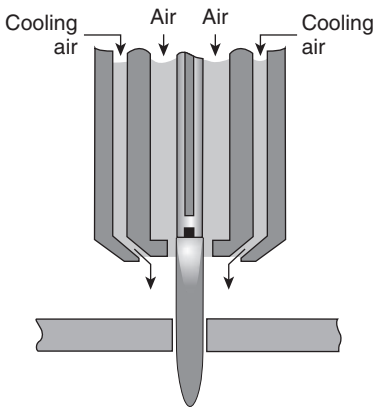

4.3 Air plasma cutting. Courtesy of TWI Ltd.

Table 4.1 Suggested parameters for plasma-jet cutting

Metal thickness	Plasma gas	Gas flow (l/min)	Shield gas	Gas flow (l/min)	Current (amps)	Voltage (volts)	Cutting speed (mm/min)	Method
1.0	Air	98					4800	Manual
1.5	Air	98					6300	Manual
3	Air	98					3000	Manual
6.5	Air	98					1000	Manual
6.5	N <sub>2</sub>	34	CO <sub>2</sub>	100			1800	Manual
6.5	Ar + H <sub>2</sub>	25			200	50	1500	Manual
10	N <sub>2</sub>	35	CO <sub>2</sub>	100	200		1250	Manual
12.5	Ar + H <sub>2</sub>	28			280	55	1000	Manual
25	Ar + H <sub>2</sub>	33			330	70	500	Manual
50	Ar + H <sub>2</sub>	45			400	85	500	Manual
6	Ar + H <sub>2</sub>	55			300	140	7500	Mechanise
6	N <sub>2</sub>	32	CO <sub>2</sub>	100	115		1800	Mechanise
10	N <sub>2</sub>	32	CO <sub>2</sub>	100	120		900	Mechanise
12.5	N <sub>2</sub>	32	CO <sub>2</sub>	100	120		480	Mechanise
12.5	N <sub>2</sub>	32	CO <sub>2</sub>	100	300		3200	Mechanise
12.5	Ar + H <sub>2</sub>	60			300	140	5000	Mechanise
25	N <sub>2</sub>	70	CO <sub>2</sub>	100	400		1800	Mechanise
25	Ar + H <sub>2</sub>	60			375	160	2300	Mechanise
50	N <sub>2</sub>	32	CO <sub>2</sub>	100	400		800	Mechanise
50	Ar + H <sub>2</sub>	60			375	165	500	Mechanise
75	Ar + H <sub>2</sub>	95			420	170	380	Mechanise
75	Ar + H <sub>2</sub>	45	N <sub>2</sub>	100	400		500	Mechanise
75	Ar + H <sub>2</sub>	45	N <sub>2</sub>	100	700		650	Mechanise
100	Ar + H <sub>2</sub>	95			450	180	750	Mechanise
125	Ar + H <sub>2</sub>	95			475	200	250	Mechanise

12.5 mm, argon–hydrogen is regarded as the best choice for the plasma gas, this gas mixture giving the best quality cut, irrespective of thickness. The secondary cutting gas may be carbon dioxide or nitrogen. Table 4.1 lists the recommended cutting/shielding gases and typical parameters for plasma cutting the aluminium alloys. Water injection into the nozzle can be used in addition to the orifice gas. This restricts the plasma jet further and produces a better quality, more square, cut, although above 50mm thickness these advantages are reduced.

A development of the process known as high-tolerance plasma-arc cutting (HT-PAC), also known as plasma-constricted arc, fine plasma or high-definition plasma, has been developed and is being used as a cheaper alternative to laser cutting of material less than 12mm in thickness. This variation to the plasma-arc process achieves a better quality cut with more perpendicular faces, a narrower kerf and a less rough finish than the

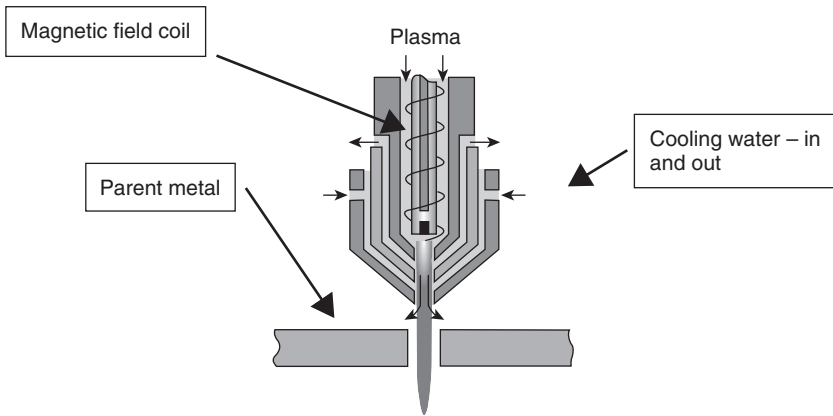

4.4 HT-PAC torch. Courtesy of TWI Ltd.

Table 4.2 Suggested parameters for HT-PAC

Metal thickness (mm)	Plasma gas	Shield gas	Current (A)	Stand off (mm)	Cutting speed (mm/min)
1.2	Air	Air	70	2	3800
2	Air	Air	70	2.5	2540
4	Air	Air	70	2	1800

plasma-arc cut by a combination of a redesigned nozzle and a constricting magnetic field (Fig. 4.4). Typical cutting parameters are given in Table 4.2.

A variation to the conventional plasma cutting process is the plasma gouging technique. This utilises a plasma-jet torch which, as shown in Fig. 4.5, is presented to the surface at a glancing angle. In doing so the surface is blown away and a groove is formed. The technique may be used to remove excess metal, to excavate for defect removal, to back-gouge the reverse side of welds and to establish a weld preparation. Needless to say it requires a skilled operator to achieve an acceptable surface and should not be entrusted to unskilled personnel since it is capable of removing large amounts of metal very rapidly.

#### 4.3.1 Health and safety

The plasma-arc process uses higher open circuit and arc voltages than does the TIG process, with operating voltages as high as 400 volts in some applications. These voltages present a serious risk of electric shock and suitable

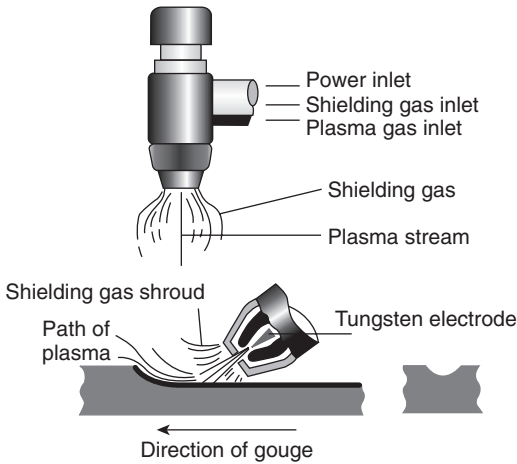

4.5 Plasma-arc gouging principles. Courtesy of TWI Ltd.

precautions must therefore be taken to ensure that cutting operations are carried out in a safe manner. Only fully trained operators should be permitted to operate the cutting equipment. All frames, casings, etc., should be connected to a good electrical earth and all electrical connections and terminals must be adequately protected. Any equipment maintenance or modification must be carried out by suitably trained and qualified staff and connections, insulation, etc. inspected at regular intervals for soundness and deterioration.

The plasma-arc produces large amounts of infra-red and ultra-violet radiation. All personnel in the vicinity of plasma-arc cutting operations therefore need to be provided with protective clothing, goggles and helmets to protect both eyes and skin. The operator must use the correct filter lenses for electric arc welding, with shade numbers ranging from 9 to 14, depending upon the current.

As with any thermal cutting process copious amounts of fume are produced. The fume will contain not only aluminium oxide but the oxides of the other elements present in the alloy, ozone, oxides of nitrogen, any surface plating or coating, any contamination and the cutting gases. These present a health hazard that is best dealt with at source by local fume extraction. Fume extraction, either local or general, will almost certainly be mandatory if the fume and gas limits set by the Control of Substances Hazardous to Health (COSHH) Regulations are to be complied with. Cutting in confined spaces presents a particular problem. Fume extraction and ventilation must be provided in these circumstances. It should be remembered that many of the cutting gases, although not toxic, are asphyxiant, are heavier than air and can accumulate in low-lying areas

such as pits and wells. Forced ventilation should be considered in such circumstances.

When plasma-arc cutting is carried out under water the dross that is produced may build up on the tank bottom. Over a period of time this dross reacts with the water, producing hydrogen which may accumulate under the item being cut, leading to a risk of explosion. This is best avoided by cleaning the tank of the dross at regular intervals or using a forced circulation water supply to carry away any gas as it is formed.

Plasma-arc cutting is a very noisy process, the noise level increasing as the cutting current is increased. Ear protection is required for the operator and personnel working in the vicinity to avoid discomfort or ear damage.

### 4.4 Laser beam cutting

A laser (light amplification by the stimulated emission of radiation) generates a coherent beam of light at an essentially constant wavelength. When this beam is focused on a surface there is sufficient energy concentrated in this focused spot that the material may be melted or vaporised (Fig. 4.6). This enables the laser to be used for either welding or cutting. The laser light is produced by exciting a lasing medium, this being either a suitable gas or solid. The excitation is provided by the passage of an electric current or by means of high-intensity light. There are two commonly used lasers to be found in industrial applications: the gas CO<sub>2</sub> laser and the solid state crystal laser, the neodymium-doped yttrium–aluminium–garnet (Nd-YAG) laser. Of the two, the CO<sub>2</sub> laser is the most powerful with average power outputs of up to 50 kilowatts. Both types of laser can be designed to provide

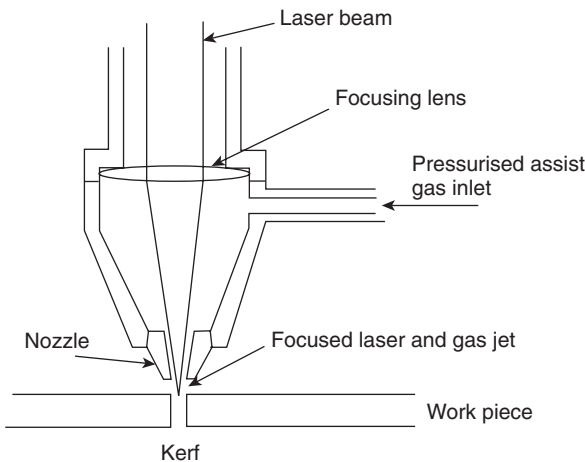

4.6 Laser cutting principles. Courtesy of TWI Ltd.



a steady output, continuous wave (CW) laser light or in a pulsed output mode. In this latter case the power output on the peak pulse may be as much as 20 times the average power.

The wavelength of light from the CO<sub>2</sub> laser is 10.6 microns (micrometres) and at this wavelength is easily absorbed by most solids, enabling the CO<sub>2</sub> laser to be used on a wide variety of materials. This long wavelength has a disadvantage, however, in that it cannot be transmitted by glass or fibre optics but requires reflecting metal mirrors for manipulating the beam and materials such as zinc selenide or gallium arsenide for focusing lenses. The Nd-YAG laser light is an order of magnitude less at 1.06 microns, allowing the use of glass lenses for focusing and fibre optic cable for beam transmission. This offers a clear advantage over the CO<sub>2</sub> laser, since it permits the marriage of commercially available manipulating equipment such as NC (numerically controlled) gantries and robots with the laser. The power output of currently available Nd-YAG lasers is limited to around 6 kilowatts, however, restricting the thickness of materials that can be cut.

The laser cutting process consists of focusing the beam through a cutting nozzle onto the surface to be cut, the concentration of energy being sufficient to vaporise the material, creating a 'keyhole'. With continuous wave lasers there is generally more melting than vaporisation and an assist gas is used to blow away the vapour and any molten metal, creating a narrow clean cut as the beam is traversed along the item. The pulsed lasers generally provide enough energy that the laser beam imparts sufficient force to the vapour that the vapour itself removes any molten metal. The assist gas, introduced either through the cutting nozzle or co-axially with it, is used not only to blow away any molten metal but also to protect the lens from spatter or debris ejected from the cut.

The assist gas for cutting aluminium may be oxygen, nitrogen or air. Oxygen is a reactive gas with aluminium and will give higher cutting speeds than nitrogen. Nitrogen, however, will give a better quality cut in terms of squareness and roughness than will oxygen. Air is a compromise but is the cheapest of the gases. Gas pressure is an important variable that needs to be controlled to give the best quality of cut – high gas pressures give the most effective metal removal but too high a pressure may damage the focusing lens, since this forms part of the pressure system. As the assist gas pressure is increased the lens also needs to be thickened in order to carry the increased pressure. The pressure of gas in the cut is also influenced by the distance between the nozzle and the workpiece. For example, high-pressure cutting may require a stand-off distance of only some 2.5 mm. The relationship between stand-off and pressure in the kerf is not simple, however, as most laser cutting is done with supersonic gas velocities. It is essential that the nozzle stand-off distance and nozzle condition are closely

controlled to provide consistent and high-quality cuts. Typical laser cutting parameters are given in Table 4.3.

A number of advantages accrue from using a laser for the cutting of weld preparations:

- Low heat input, resulting in minimal distortion and narrow heat affected zones.
- Edges that are smooth and perpendicular to the surface and often require no further cleaning before welding.
- Narrow kerfs and heat affected zones, meaning that more efficient nesting can be achieved, resulting in material savings.
- Very thin materials can be cut without distortion.
- Very accurate cuts can be made, resulting in more easy assembling for welding, this giving reduced fit-up time, more accurate fit-up and fewer weld defects.
- The process is easily automated and can be readily interfaced with other NC equipment (Fig. 4.7).

The main drawbacks to the use of lasers for the cutting of aluminium are as follows:

- The capital cost of equipment, which may be in the order of several hundreds of thousands of pounds for a laser interfaced with suitable manipulating equipment. A 1.5kW CW Nd-YAG laser interfaced with a robotic system, together with its appropriate safety equipment will cost in the region of £250k to £300k at today's (2002) prices.
- The coupling of the beam with the work surface is not very good since aluminium can be highly reflective. This means that higher power is needed to cut an aluminium component than a similar item in steel. Aluminium may also reflect the beam back into the lens, resulting in damage, although this problem has lessened with the development of more accurate lenses and focusing systems.
- Laser cut aluminium may have a heavy dross on the underside of the cut. Removal of this can make the process non-competitive with other processes. Higher gas pressures will assist in reducing or eliminating the problem.
- The cut edges of the age-hardening alloys may contain microfissures that will need to be removed.

#### 4.4.1 Health and safety

The laser cutting process is a thermal process and therefore metal fume mixed with the assist gas will be generated. This fume will need to be removed, preferably by local fume extraction at source. As laser cutting is

*Table 4.3* Parameters for laser cutting

Process	Thickness (mm)	Average power (kW)	Pulse frequency (Hz)	Pulse width (ms)	Assist gas	Gas pressure	Cutting speed (mm/min)
Pulsed Nd-YAG	1.2	0.174	120	1	oxygen	4	6000
	2	0.414	100	0.5	oxygen	6	540
	4	0.224	31	1.5	oxygen	7	60
CW Nd-YAG	2	2	na	na	oxygen		4500
	2	2	na	na	nitrogen		300
CW CO <sub>2</sub>	1.2	1.41	na	na	oxygen		3800
	2	1.2	na	na	oxygen		3000
	4	1.5	na	na	oxygen		1200



4.7 CNC CO<sub>2</sub> laser cutting machine. Courtesy of Messer Griesheim.

performed with mechanised or automated systems using remote control there is only a limited risk of fume exposure for the operator. However, a laser cutting system generally has a very high usage and fume extraction will be required to control the general fume level within the shop.

The voltages used in laser equipment are sufficiently high to present a serious risk of electric shock. Access panels should be secured and suitably marked to highlight the risks. Only authorised and trained personnel should be permitted access to the equipment for repair and maintenance purposes. A typical laser work cell is illustrated in Fig. 4.8.

There are two hazards associated with laser radiation which, depending upon the wavelength, can damage either the eye or the skin. The radiation can damage the retina and/or the cornea, particularly the shorter wavelength radiation which can be focused by the lens of the eye on to the retina. Exposure of the skin can result in burns. With high-power lasers these burns may be deep and can cause permanent damage. To prevent such damage it is generally necessary to position the laser inside a suitable enclosure with interlocks to prevent access when the laser is operating. Screening of the CO<sub>2</sub> laser beam can be provided by clear glass or acrylic screens. Tinted welding screens are required for the solid state lasers since the radiation is closer to the wavelength of visible light than that of the gas laser. Personal eye protection for the operator is also recommended, selected to filter out the appropriate wavelength of laser light.

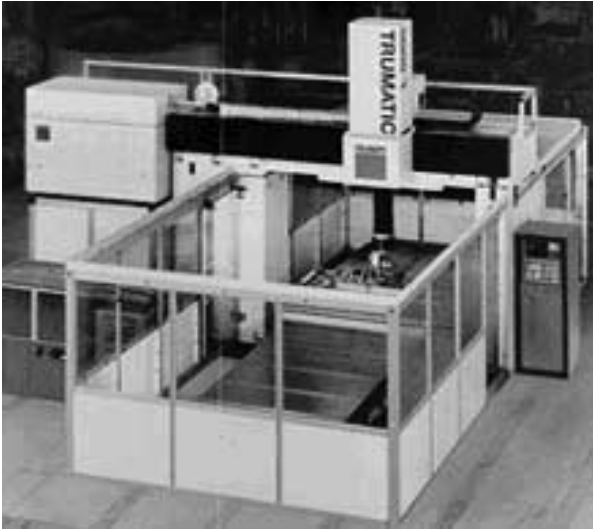

4.8 Laser welding and cutting work cell. Courtesy of TWI Ltd.

Visible radiation is also emitted during laser cutting, this light being similar to that produced from a welding arc containing both ultra-violet and infra-red light. To filter this out requires tinted filter glasses, the density of the shade being sufficient that no discomfort is felt when viewing the bright plume associated with the beam. This radiation may also cause skin reddening. It goes without saying that all personnel involved in laser processing operations should be fully trained in the use of eye and skin protection equipment.

## 4.5 Water jet cutting

Water jet cutting uses an abrasive powder introduced into a very high-pressure and velocity water jet and is capable of cutting both metallic and non-metallic materials essentially by a process of erosion. Water velocity is in the region of 2500 km/h (1600 mph) and water pressure between 2000 bar (30000 psi) and 4000 bar (60000 psi). One of the most important uses of water jet cutting is the roughing out of parts prior to finish machining. The great advantage that water jet cutting has over the laser or plasma-arc is that no heat is used in the process. There are therefore no heat affected zones and no thermal distortion. Parts can be cut very accurately and closely nested, resulting in material savings. Cut part tolerances are very small, simplifying the task of fitting up for welding.

Although aluminium up to 450 mm in thickness can be cut using the process, the limitations with water jet cutting are the cutting speed, which

may be only a quarter the speed of a laser cut component, particularly in thin sections. The other limitation is the bevel or taper of the cut face which may be twice that of laser cutting, some 25% of the nozzle diameter or around 0.2 mm at the optimum cutting speed. The bevel can be reduced by slowing the cutting speed with the penalty of an increased cost.

## 4.6 Mechanical cutting

Although the methods mentioned above can be applied to many fabricating activities, mechanical cutting techniques are used by most welding workshops as being the most cost-effective and versatile method. Cutting and machining equipment is freely available in most fabrication shops and is frequently less capital intensive than the sophisticated laser or plasma cutting systems discussed above. Furthermore, the systems described in Sections 4.2, 4.3 and 4.4 are capable of straight or simple bevel cuts only – if double bevel preparations are required then two or more cuts are necessary and J-preparations are not feasible. Edge preparations can be produced in a number of ways such as high-speed milling machines, edge planers, routers and various types of saws. Where air-powered equipment is used care needs to be taken to ensure that the air supply is clean, dry and oil-free to prevent contamination of the surfaces, which would give rise to porosity during welding.

Routers, planers and edge millers are capable of producing J- and U-preparations when fitted with the correct shape of tools. The equipment for these tasks can be hand-held and similar to that used for wood working, the only requirement being the need for slightly greater power or floor mounts for greater capacity. High cutting speeds can be used without the need for lubricants or coolants, although this does not remove the need for thorough cleaning. Hand-held rotary cutting machines are ideally suited to back-gouging and for removing excess weld metal. The depth of cut can be adjusted and various cutter forms are available, including V-blades for bevelling and flat blades for weld cap removal.

The guillotine can be used to shear sheets of up to 6 mm thickness without the need for further preparation work. Over this thickness some dressing of the sheared edges is necessary if the best weld quality is to be achieved. Shearing of the edges of alloys containing more than 3.5% Mg is not recommended if the edges are to enter service 'as sheared' because of the risk of the work-hardened edges suffering from stress corrosion cracking. Edges that are welded after shearing do not suffer from this problem.

Sawing is a very effective method of cutting and bevelling aluminium using either portable or floor-mounted equipment. To achieve a good quality cut high cutting speeds are necessary, around 2500 metres per minute (mpm) peripheral surface speed for high-speed steel circular saw

blades, 3500mpm for tungsten-tipped blades and 1800mpm for band saw blades. It is usual for band saw blades to have wider spacing on the teeth than for steel to prevent snagging, 8 to 16 teeth per centimetre being recommended. Band and circular saws can produce straight cuts and, when equipped with a tilting table, bevelled cuts. The saw cut surface tends to be rough and readily traps grease and dirt, making cleaning and degreasing difficult. It is recommended that the sawn faces are milled or filed to produce a smooth surface when the best quality of weld is required.

Grinding is best performed with high-speed, semi-flexible aluminium oxide grinding discs. Care needs to be taken to ensure that the grinding is controlled and is not heavy handed. Over-enthusiastic grinding can give a torn and rough surface which will be difficult to clean. Material may also be smeared over the surface, physically trapping dirt and grease and giving rise to porosity on welding. Rotational speed of the discs needs to be in the region of 8500rpm. Care should be taken that the grinding machines are capable of maintaining these speeds when under load – some machines are incapable of attaining or maintaining these speeds in operation. Grit sizes range from 24 to 120 and the discs selected should be of the non-loading type. Under these conditions the discs should not become clogged and the speed of metal removal should not be affected. Grinding can be used to clean the weld preparation prior to welding, to blend the weld into the parent metal, to remove excess weld metal and to back-grind a partially penetrated weld to sound metal. To achieve the best results this requires suitable and well-maintained equipment operated by trained personnel.

Hand-held abrasive belt sanders are readily available and enable finishing operations to be carried out without too great a risk of damage owing to incorrect manipulation of the sander. Belt widths of 3–100mm can be purchased; the narrow belts in conjunction with sander arms of up to 500mm in length enable dressing operations to be carried out when access is very restricted.

Most machining and grinding operations can be carried out without lubrication. Dust may therefore be a problem and operators may need to be equipped with dust masks or respirators and the equipment with dust collectors. Noise can also be a problem and ear defenders will be needed for some of the machining and grinding tasks.

One last but very important point to be made before ending this section on the cutting and machining of weld preparations is that the equipment must not be used on aluminium if it has been used on other metals. Cross-contamination of aluminium with copper, iron, etc., may result in welding or service problems. Wire brushes, grinding discs, cutters and milling heads must only be used on aluminium and should be identified as such if there is any possibility of cross-contamination. Machining equipment should be

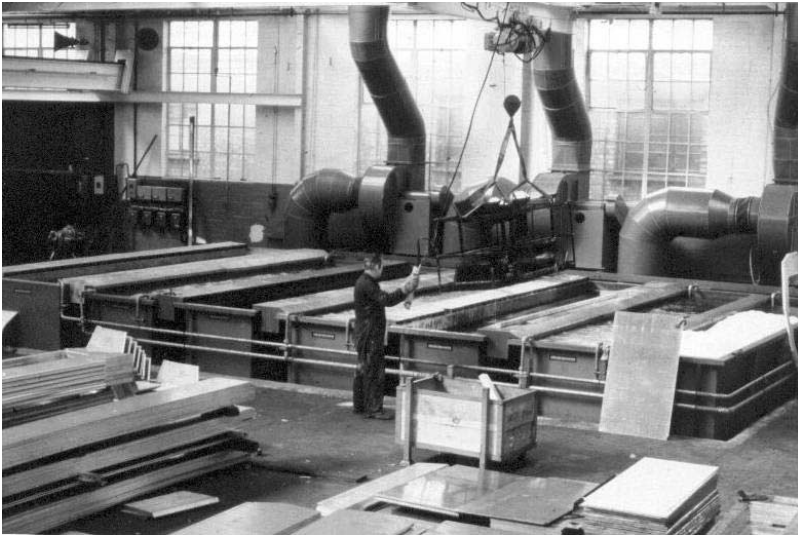

4.9 Typical pickling shop. Courtesy of R. Andrews.

thoroughly cleaned of any foreign metals before being used on aluminium alloys.

## 4.7 Cleaning and degreasing

Components for welding may be flat, preformed, sheared, sawn or milled to give the desired shape or to provide the weld preparation. Lubricants used during these processes *must* be removed if weld quality is to be maintained. Degreasing may be accomplished by wiping, brushing, spraying or vapour degreasing with commercially available solvents. This is best done before any mechanical cleaning takes place. Mechanically cut edges may carry burrs along the cut edge that will trap dirt and grease. These burrs should therefore be removed from weld preparations by scraping with a draw tool – do not wire brush only as this may fail to remove them completely. Scraping is also an excellent method for removing the oxide film. Stainless steel wire brushes, stainless steel wire wool or files may also be used to remove the oxide. As mentioned above in Section 4.6, under no circumstances should carbon steel, brass or copper brushes be used. Make sure that any cleaning tools are segregated and are used only on aluminium, otherwise cross-contamination can occur.

In certain cases, particularly when striving to achieve freedom from porosity, chemical cleaning or pickling may be required. A pickling shop is illustrated in Fig. 4.9 and a schedule of chemical cleaning treatments is given in Table 4.4.



Table 4.4 Chemical treatments for cleaning and oxide removal

Solution	Concentration	Temp (°C)	Procedure	Container material	Purpose
Nitric acid	50% water 50% HNO <sub>3</sub> (technical grade)	18–24	Immerse 15 min Rinse in cold water Rinse in hot water Dry	Stainless steel	Removal of thin oxide film for fusion welding
Sodium hydroxide followed by nitric acid	5% NaOH in water	70	Immerse 10 to 60s Rinse in cold water	Mild steel Stainless steel	Removal of thick oxide film for all welding and brazing operations
	Concentrated HNO <sub>3</sub>	18–24	Immerse 30s Rinse in cold water Rinse in hot water Dry		
Sulphuric – chromic acid	5 litres H <sub>2</sub> SO <sub>4</sub> 1.4kg CrO <sub>3</sub> 40 litres water	70–80	Dip for 2 to 3 min Rinse in cold water Rinse in hot water Dry	Antimonial lead lined steel tank	Removal of films and stains from heat treating and oxide coatings
Phosphoric – chromic acid	1.98 litres of 75% H <sub>3</sub> PO <sub>3</sub> 0.65kg of CrO <sub>3</sub> 45 litres of water	95	Dip for 5–10 min Rinse in cold water Rinse in hot water Dry	Stainless steel	Removal of anodic coatings

Once degreased and cleaned the parent material should be welded within a short period of time; typically four hours would be regarded as reasonable. The component must be maintained in a clean condition during this time and this may require the item to be covered with polythene sheets or brown paper. If the item is left standing overnight the joints may require an additional cleaning operation so it is advisable to clean only those parts that can be welded within a four or five hour production period.

There are a couple of points concerning cleanliness that are worth mentioning. If the chemical cleaning has been extremely good then it is possible to leave the components for a longer period of time, perhaps overnight if the storage conditions are clean and dry. It has also been noticed that when the items are 'super clean' the TIG or MIG welder can experience arc starting and stability problems. The reason for this is not clear but is probably associated with the complete absence of any oxide. It is thought that a small amount of oxide assists in the formation of an active anode spot, resulting in a more stable arc.

The aluminium fabrication area ideally should be separated physically from other fabrication areas. For example, dust from activities such as grinding, settling on the surface will cause problems, particularly if this is from the grinding of steel items in adjacent bays. Aluminium and steel should never be welded in the same welding booth. It cannot be emphasised too strongly how important attention to cleanliness is if sound, defect-free welds are to be made consistently.

## 5.1 Introduction

In all constructional applications where welded connections are used either a stress analysis is carried out or ample experience of acceptable performance exists for the specific joint design. The principles of stress analysis are outside the scope of this chapter – it deals instead with those shop-floor fabrication activities that the designer directly influences. There are many national and international specifications dealing with the design aspects of specific structures. For instance, BS 8118 deals with the structural use of aluminium, as does the US specification D 1.2. Pressure vessel design is covered by BS PD 5500 and ASME VIII. For advice on the design of such structures the designer can do no better than consult the relevant specifications. For a list of relevant specifications see Appendix A at the end of this book.

The objective of the designer is to provide an assembly with adequate strength for the specific application with the least amount of weld metal and the minimum number of joints. This requires the designer to plan for a smooth flow of stresses through the joint, to compensate for any strength loss due to welding, to design the component such that there is sufficient access for welding and to select the metal to be welded with optimum weldability in mind. As mentioned in Chapter 2 there is little that can be done to improve the strength of the weldment to match that of the cold worked or precipitation-hardened alloy. All that the designer can do to compensate for the loss is to thicken the component, either overall or locally, or to move the weld to an area of low stress. For advice consult British Standard BS 8118 or the AWS Structural Design Code D 1.2, as mentioned above.

There are a number of factors that the designer needs to take into account that are specific to designs in aluminium. Some of these have been mentioned in earlier chapters and include such physical properties as the high coefficients of thermal conductivity and expansion, the major loss of strength of certain alloys in the HAZ and the low Young's modulus. In

addition, the designer must consider access for both welding and inspection, joint design to enable high-quality welds to be made, the effects and minimisation of distortion and the effect of welding on stress concentrations and fatigue.

The ease with which a weld can be made is crucially dependent on joint design and this will have a direct effect on fabrication costs. It is thus essential that the designer is aware of certain fundamentals of welding practice in order to achieve the objectives of the lightest structure capable of performing its desired function at the lowest cost.

There are a number of 'golden rules' that the designer should keep in mind when detailing the drawings:

- Remember that weld metal is very expensive. Do not over-specify fillet weld throat thickness and specify the narrowest weld preparation angle that is consistent with quality. Specify these sizes clearly.
- Keep welding to a minimum – use formed sections instead of welded plate, keep stiffeners to a minimum. The cheapest weld of all is the one you do not make!
- Specify welds to be made in the flat position.
- Allow adequate access for the welder – see below.

## 5.2 Access for welding

The two most common design faults are failing to recognise that full vision of the weld pool is essential for manual welding and that the weld must be at a comfortable distance from the operator, neither too close nor at a distance where the welder's arm is at full stretch. These errors can frequently be recognised at the design stage and the benefits of requiring an experienced welding engineer to review draft drawings cannot be over-emphasised. The distance from the operator's head to the weld can easily be checked on drawings. Ideally this distance should be in the region of 200mm minimum to 450mm maximum. It should be remembered that the diameter of the welder's helmet is about 300mm and that this will affect the access requirements.

For a joint to be accessible for manual welding welders must be able comfortably to position themselves and their equipment if high-quality welds are to be produced. This requires sufficient space to permit free movement of the welding torch or electrode and to enable the torch to be presented to the weld pool at the correct angle. Detail design must also take into account the proximity of adjacent material which should be such that the welder is allowed an unrestricted view of the arc. The amount of space required will depend on the size of the equipment to be used, in particular the size of the torch. Welding aluminium with the gas shielded processes

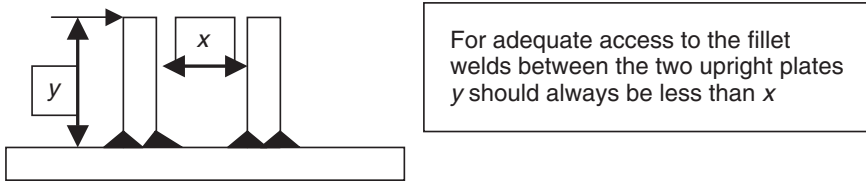

5.1 Access requirements for welding.

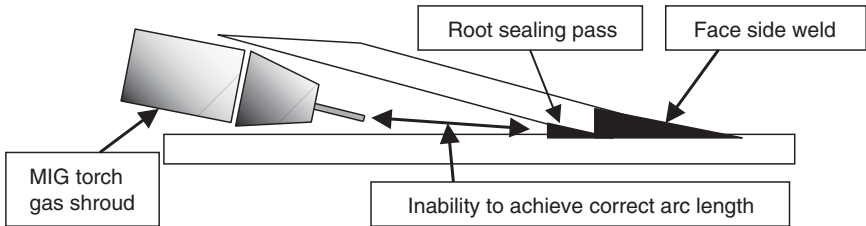

5.2 Access problems of angled plates or pipes.

requires a large diameter gas shroud and a short arc length. This means that the welder's view of the weld pool is more restricted than when welding a similar configuration in steel. The sketch in Fig. 5.1 illustrates a situation that is often encountered in practice where the designer has failed to take into account the need for adequate access. As a rule of thumb the distance between the plates should be as shown. A further limitation for TIG welding is the need to add a filler wire that restricts further the welder's view of the arc and the ease of manipulation as both of the welder's hands need to be in the work area.

The welding of attachments or nozzles to plates or pipes can present problems when the nozzle is presented to the surface at an angle less than  $45^\circ$ . Access into the acute angle is difficult, resulting in lack-of-fusion defects in the root of the weld as illustrated in Fig. 5.2.

### 5.3 Welding speed

Aluminium is normally welded at higher travel speeds than when welding steels, particularly when using the MIG process. The implication of this is that abrupt changes of direction are to be avoided. It is, for example, impossible to weld around a  $90^\circ$  corner as the MIG torch cannot be moved rapidly enough to keep the correct lead angle. It is also difficult to weld around small diameter bosses fixed in position. In this sort of application the boss needs to be rotated with the torch held stationary. Such comments do not necessarily apply when fully mechanised or robotic equipment is used.

Automation or the use of robots enables torch positioning and motion to be controlled with the precision required for the production of quality welds.

## 5.4 Welding position

Welding in the flat or downhand position is preferred for all arc welding activities. It is easier for the welder to deposit high-quality weld metal at high deposition rates in the flat position than in any of the other positions. The weld pool is larger in this position with slower solidification and cooling rates, permitting gases to evolve from the pool and reducing the amount of porosity. The force of gravity in positions such as the horizontal-vertical, however, means that the weld pool tends to sag, making it more difficult to achieve an acceptable weld profile. These effects are more marked with MIG than with TIG. Flat position welding therefore gives the best quality weld metal at the lowest cost.

The designer should take these points into account when considering the design of a structure. Wherever possible welding should be performed in the flat position. This may require the fabrication of sub-assemblies that are more easily manipulated. Manipulating equipment such as rotators or face-plate manipulators are useful for items too large for manual handling. The use of this equipment, however, may require the welding of temporary attachments to the component to facilitate fitting the component to the manipulator. As much care must be taken with the welding and removal of these attachments as is applied to the permanent joints – formal welding procedures should be considered in order to exercise control over this sometimes haphazard activity.

## 5.5 Edge preparation and joint design

There are few more important decisions that affect the success of welding than that of correct joint design. Problems with weld quality or performance can often be attributed to the wrong design of edge preparation. Joint design is determined by the strength requirements, the alloy, the thickness of the material, the type and location of the joint, the access for welding and the welding process to be used.

There are three fundamental forms of weld, the butt, the fillet and the edge weld, illustrated in Fig. 5.3, from which can be developed six basic joint types. These are the butt, T-joint, corner, cruciform, edge and lap joint, illustrated in Fig. 5.4.

The static tensile strength of these weld types is determined by the *throat thickness* (Fig. 5.5). The size of a fully penetrated butt weld is determined by the thickness of weld metal deposited within the plane of the plate or

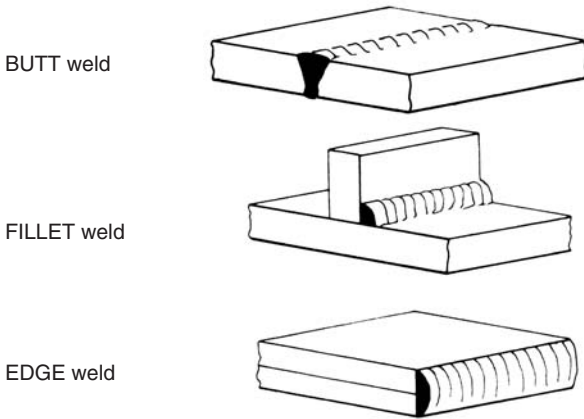

5.3 Butt, fillet and edge welds.

(a) BUTT joint

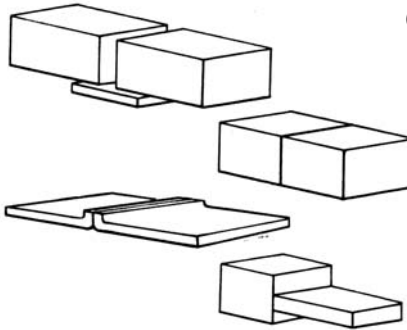

(b) T-joint

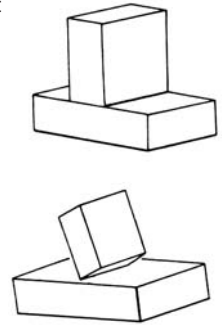

(c) LAP joint

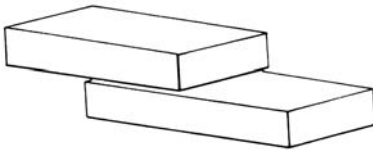

(d) CRUCIFORM joint

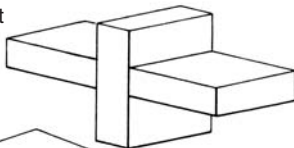

(f) CORNER joint

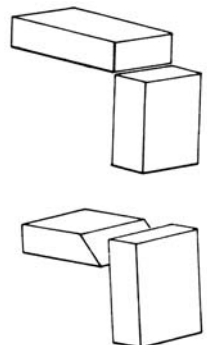

(e) EDGE joint

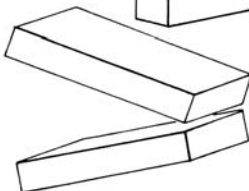

5.4 Joint types developed from the butt, fillet and edge weld.

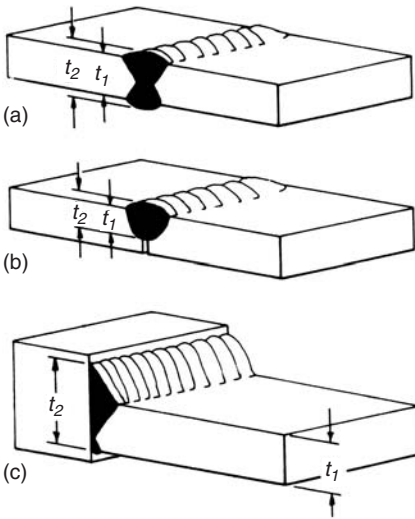

5.5 Throat thickness in a butt weld: (a) full pen butt weld; (b) partial pen butt weld; (c) T-butt weld.

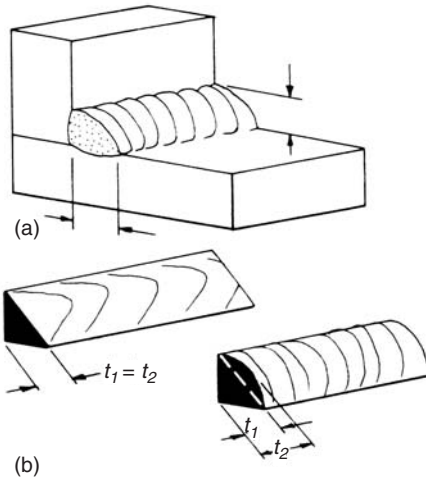

5.6 Throat thickness in a fillet weld: (a) fillet weld; (b) mitre and convex fillet weld.

pipe,  $t_1$  in Fig. 5.5. No credit is taken in calculating permissible static design stress of either a butt or fillet weld for the excess weld metal, i.e. that above the surface of the parent metal for a butt or outside the isosceles triangle of a fillet weld as given by  $(t_2 - t_1)$ .



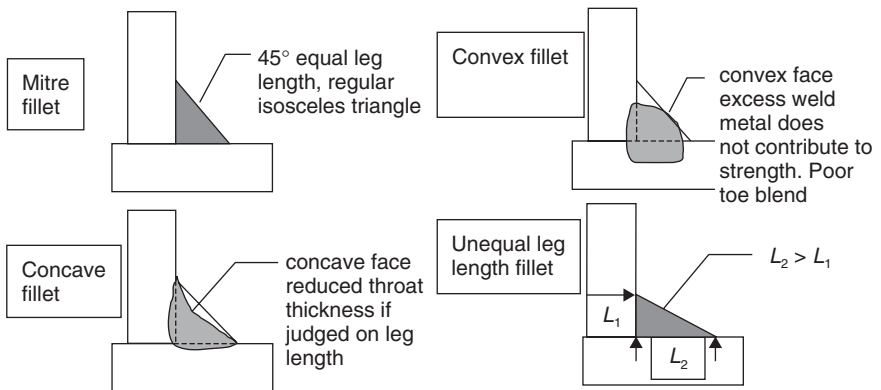

5.7 Mitre, convex, concave and unequal leg length fillet.

For the fillet weld the shape of the weld and the amount of penetration into the root will affect the throat thickness. The *effective* throat thickness is  $t_f$  in Fig. 5.6. The size of the fillet weld must be determined by the designer and should be of sufficient size to carry the load. The throat may therefore be completely different from the material thickness.

The fillet weld may also be described as a *mitre*, a *concave* or a *convex* fillet. In addition the fillet weld may have unequal *leg lengths*. These four types of fillet weld are illustrated in Fig. 5.7.

### 5.5.1 The butt weld

The butt weld, typical forms of which are illustrated in Fig. 5.8, is a simple and easily designed joint which uses the minimum amount of material. Figure 5.8 also includes definitions of some of the features of a *weld preparation* such as 'root face', 'angle of bevel' and 'included angle'. Butt welds, as illustrated in Fig. 5.5, may also be classified as *full penetration* or *partial penetration*.

With the conventional fusion welding processes of TIG and MIG penetration of weld metal into the surface of a flat plate from a bead-on-plate run is typically 3 mm and 6 mm respectively. To achieve a full penetration butt weld at thicknesses over these it is necessary for the two close square-butted edges to be bevelled, although leaving a small gap between the edges will increase penetration. Typical weld preparations for the various processes will be found in the relevant process chapter. Butt joints may be single or double sided – if double sided it is often necessary to back-gouge or back-grind the first side to be welded to achieve a joint that is free of any lack of penetration.

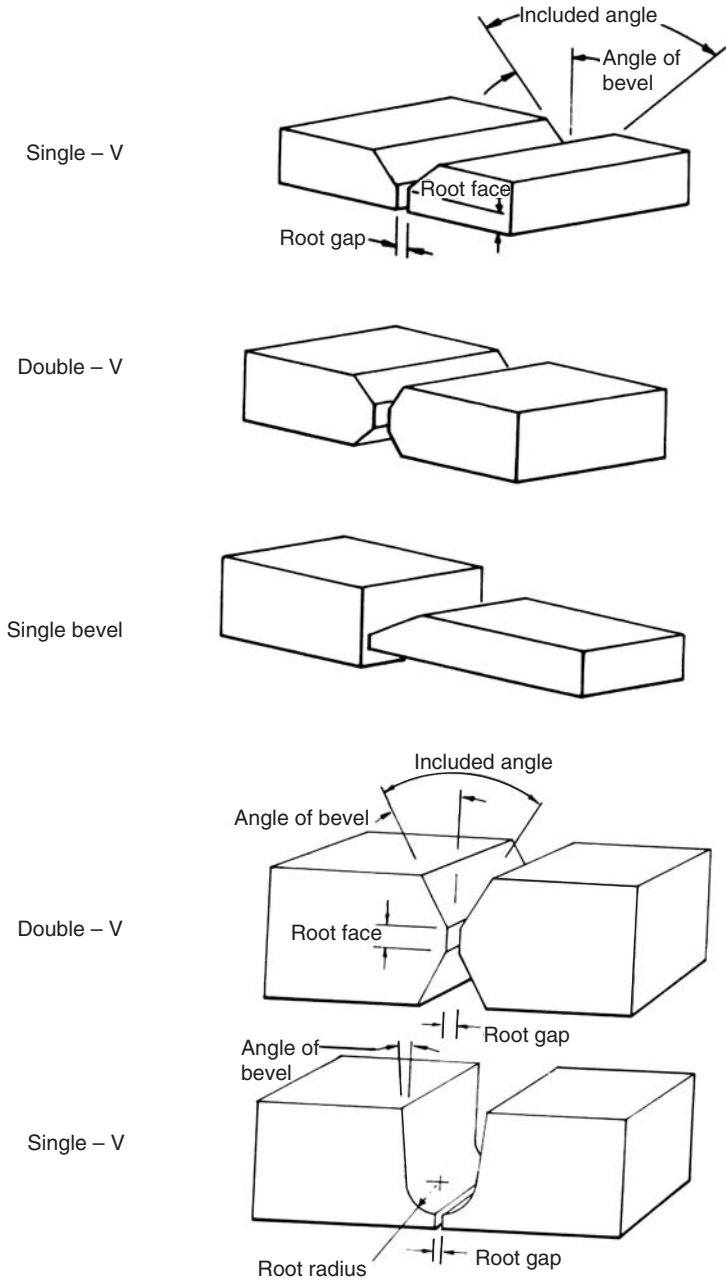

5.8 Various forms of the butt weld.

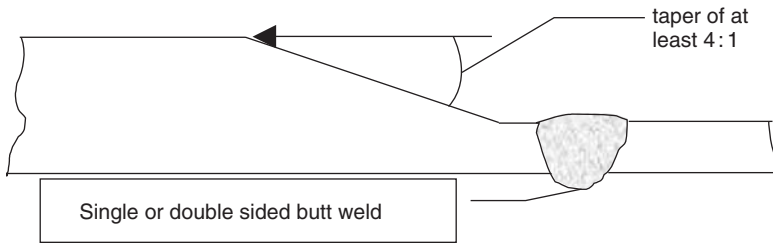

5.9 Suggested design for the joining of dissimilar thickness plates.

The effective size of a full penetration butt weld equals the design throat thickness, essentially the plate/pipe thickness of the thinner component. As mentioned elsewhere no credit is taken for the weld metal cap height or root penetration bead. Although not often used in aluminium fabrications because of the need to match joint strength and base metal strength, in lightly loaded joints a partial penetration joint (Fig. 5.5b), may be acceptable. Partial penetration can be achieved by the use of a close square butt joint or a thick root face. There are cost benefits associated with the partial penetration joint as little or no edge preparation is required, it is economical on filler metal and it is easy to assemble since the root gap does not need to be controlled. The limitations are that radiographic interpretation is difficult due to the lack of penetration, the fatigue life is compromised and static mechanical strength is reduced. The effective size in the case of the partial penetration weld is the throat of the weld minus the cap height.

Where two sections of unequal thickness are to be welded the welder's task will be eased and the best properties, particularly fatigue, will be achieved if the thicker of the two is bevelled or tapered to match the thinner. The taper on the thicker component to achieve this should be in the region of 4 to 1 to reduce the stress-raising effects of an abrupt change in thickness (Fig. 5.9).

The weld preparation shape may be selected to achieve root penetration and a sound root, to permit the required pass sequence or to control weld metal dilution from the parent metal. The MIG process can, but with difficulty, be used to produce a sound, defect-free penetration bead – for a sound joint either a backing bar or strip needs to be used or the weld must be cut-back and a second side weld made. These techniques are dealt with in greater detail elsewhere. The TIG process can be used to make a sound, fully penetrated root bead without a cut back or backing strip. A 'landed' bevel joint (Fig. 5.10) is designed to enable the highest quality root penetration bead to be made using the TIG process. This is of use in applications such as pipe butt welding, where the welds need to be single sided and to have a smooth root bead that will not hinder flow in the pipe.

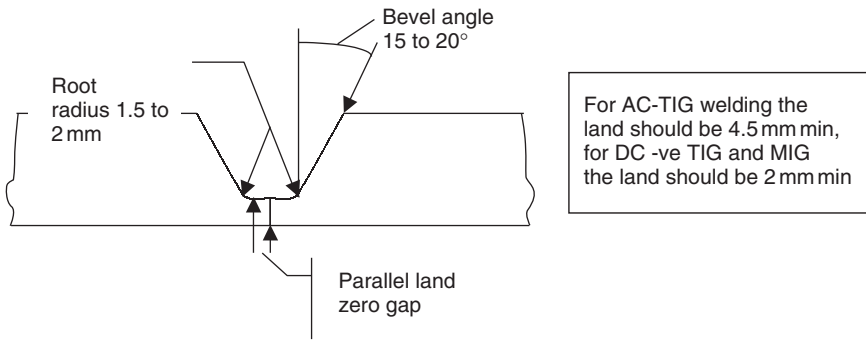

5.10 'Landed' single-V butt weld.

The strength of a sound, defect-free butt weld generally matches that of the filler metal or the annealed strength of the parent metal, as discussed in Chapter 2. The butt joint is the best in a dynamic loading environment, particularly if the excess weld metal is dressed flush. To achieve the best properties the two component parts require accurate alignment, which implies adequate tacking, jiggling and fixturing.

### 5.5.2 Backing bars and backing strips

Although it is possible to deposit a sealing run on the reverse side of a butt weld without a back-gouge, this cannot be relied upon to give a sound, defect-free weld. Single sided joints may be welded by TIG to produce a sound root pass but the conventional (non-pulsed) MIG process often requires either permanent or temporary backing on which to deposit the MIG root pass. The purpose of the backing bar or strip is to support the root pass where conditions make the control of the bead difficult. Conventionally, a backing *bar* is temporary and can be lifted away as soon as the weld has been completed, and a backing *strip* is a permanent part of the joint. A backing bar or strip can greatly simplify the task of setting up the joint – for example, root gap variations are easily coped with and joints can be self-jiggling, good root bead appearance can be achieved and costs can be reduced.

A grooved temporary backing bar will produce good penetration bead shape, the groove being used as a mould for the molten weld metal. This will provide a better dynamic performance than a permanent backing strip. Backing bar material can be an inexpensive mild steel but a longer life can be obtained from the bar with less risk of contamination if stainless steel is used. Ceramic backing, provided as a flexible strip of tiles or on adhesive tape, can also be used. Copper or copper alloys should be avoided because

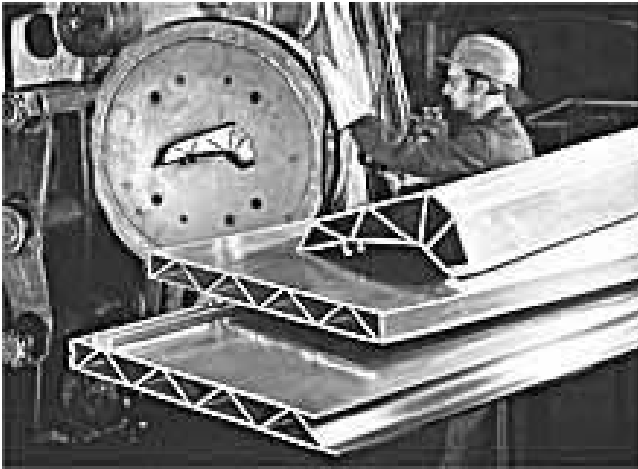

5.11 Typical self-jigging extrusions. Courtesy of ALCAN.

of the risk of contamination. An ungrooved backing bar will need the root pass to be back-ground and perhaps a sealing pass to be deposited to produce a sound weld. If TIG welding using a backing bar the weld should be made with no root gap. This is necessary to prevent the TIG arc acting directly on and perhaps melting the backing material.

The permanent backing strip is fused into the root pass and care must be taken to select an alloy that is compatible with the parent metal and the filler. The strip should be in the region of 4–6 mm thick and tacked in position. Many extrusions in aluminium, however, can be produced with the backing strip incorporated and in this way joint set-up is simplified. It is possible to design the extrusions with both the backing strip built in and of such a shape that the joint is self-jigging, as illustrated in Fig. 5.11.

The crevices associated with permanent backing strips result in local stress concentrations. These may reduce both impact and fatigue resistance if the root is in a highly stressed area. The crevice may also give rise to localised corrosion although even in marine environments this has not been reported as a major problem when the correct alloy has been chosen. Despite these potential drawbacks, permanent backing strips are a common feature in many structures used in challenging applications.

Inert gas backing can be used for critical applications such as food processing or pharmaceutical process pipework or vessels and is very useful when there is no access to the back of the weld to back-gouge and seal. An argon purge will prevent oxidation of the root penetration bead and oxide films being fused into the joint, giving a smooth, even TIG root bead. Typical designs of backing bars and strips are given in Fig. 5.12.

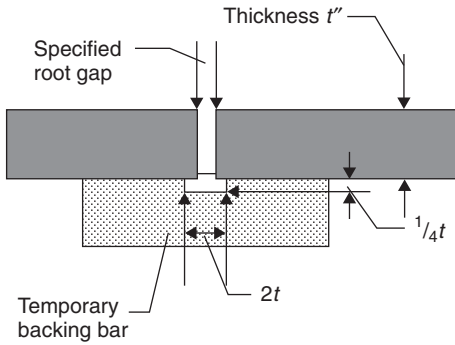

Suggested design of a temporary backing bar for plate or pipe less than 6mm thick

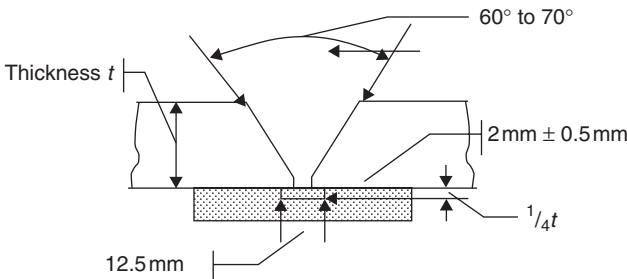

Temporary backing bar design for plate over 3mm thick (TIG) or 6mm thick (MIG)

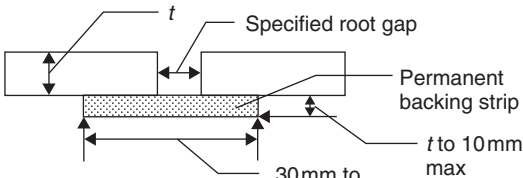

Permanent backing strip design for both thick and thin plate

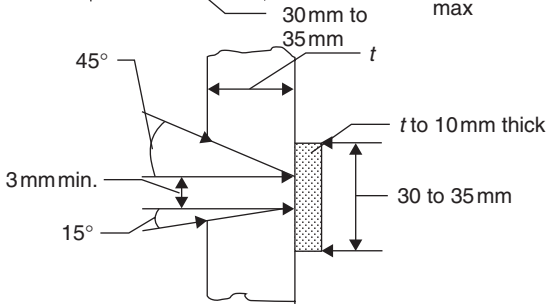

Suggested weld preparation and backing strip for horizontal-vertical (PC) welding position

5.12 Backing bar and strip designs.

### 5.5.3 The T-joint

As the name infers, the T-joint (Fig. 5.4b) is one where one member is positioned at approximately right angles to its partner with the most usual applications being plate to plate or branch connections. The upright of the T may be joined by a butt weld, by a fillet weld or welds or by a combination of

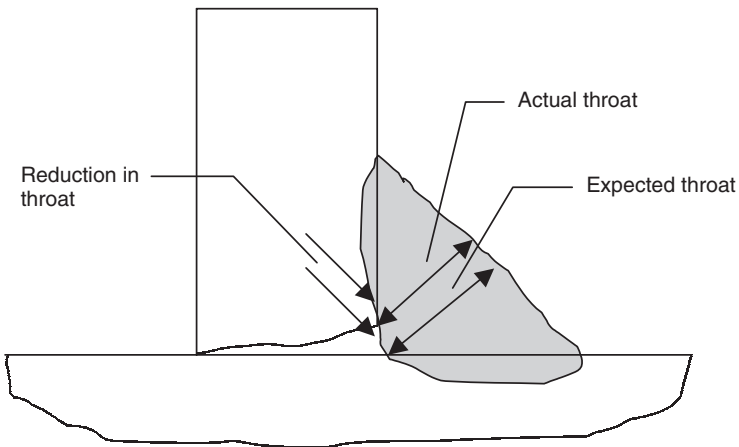

5.13 Effect of an irregular cut edge on the fillet weld throat thickness.

the two weld types (Fig. 5.5c). The T-joint is a simple, easily designed weldment which, except in the case of the T-butt, requires little or no edge preparation. The accuracy of the fit-up depends to a great extent on the accuracy with which the edge of the upright of the T is prepared. An irregular cut will give a variable gap, which may result in an inadequate throat thickness as illustrated in Fig. 5.13.

A fillet weld can present difficulties in achieving full penetration into the root, resulting in a void being formed in the corner. This is regarded as undesirable, particularly in critical applications, as this lack of fusion acts as a stress raiser in the root and also reduces the throat thickness. The welder needs to be made aware of this problem as the main cause is incorrect welder technique.

If the T-butt is a flanged joint, sufficient metal must be left that the weld does not melt away the corner of the flange and to allow for variations in fit-up. As a rule of thumb, some 2.5 to 3 times the fillet weld leg length is regarded as being adequate (Fig. 5.14). This may not prevent the edge of the flange from buckling due to distortion from the heat of welding, particularly where the fillet size is large in proportion to the flange thickness.

The strength of a fillet welded T-joint is determined by the shear strength of the fillet weld or welds, the strength of a butt-welded T-joint by the strength of the weld metal or the HAZ. If the joint is subjected to transverse shear loads the bending stresses in the joint can lead to premature failure, particularly if the joint is fillet welded on one side only. Fillet welds on both sides or a full penetration T-butt joint will permit substantially increased loads before failure occurs (Fig. 5.15). Dynamic performance of T-joints is not good: the change in section from the horizontal to vertical

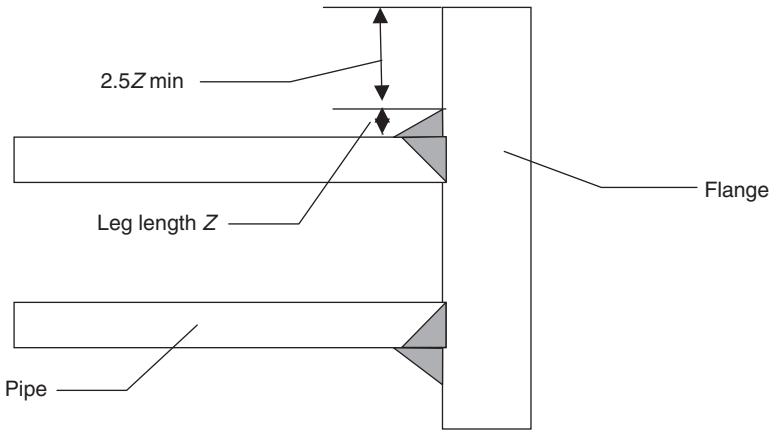

5.14 Recommended distance of weld toe from the flange edge.

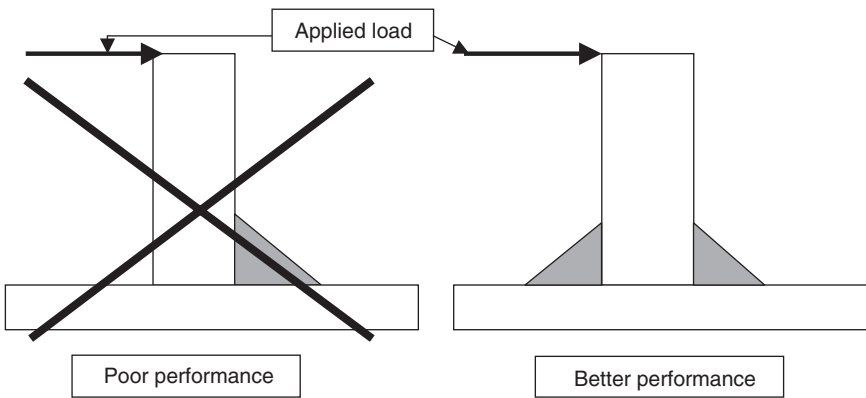

5.15 Redesign of side loaded fillet welds for improved performance.

member gives rise to high stresses at the weld toes, drastically shortening the fatigue life.

### 5.5.4 The corner joint

The corner joint may be regarded as a butt joint and is used to join two plates at right angles to each other (Fig. 5.4f). It can be difficult to assemble and maintain correct alignment, particularly in thin flexible sheet. The root of a single-sided weld when loaded in tension is very weak and for the highest strength the corner joint needs to be welded from both sides. The single-sided weld may also have a crease containing oxides along the centre line of the penetration bead, further reducing the strength of the weld. Pulsed AC-TIG has been found to be effective in reducing the occur-



rence of this feature. The corner joint is most often found in low load-carrying applications and in sheet metal work.

### 5.5.5 The edge joint

The edge joint (Fig. 5.4e) is simple to assemble and to hold in position during welding. Like the corner weld, it is weak in loading situations that put the root in tension and is rarely used in a structural application, being confined to non-load-carrying applications in thin sheet metal. Melting of the corners of the edges being joined can be a problem and may result in a shallow, low throat thickness weld.

### 5.5.6 The lap joint

The lap joint is perhaps the easiest joint of all to assemble. It comprises two overlapping plates joined by a fillet weld (Fig. 5.4c). Variations in component sizes are easily accommodated and no edge preparation is required, although a bevel, as in Fig. 5.16, may be used to guarantee full root fusion.

The joint is uneconomical in terms of material as the overlapping material is waste. The overlap should be at least three times the thickness of the thinner plate. Care also needs to be taken to ensure that the weld does not melt away the corner of the upper plate as this results in a reduction in the effective throat thickness of the fillet.

The joint strength is set by the shear strength of the fillet weld. Weld sizes and lengths should be specified by the designer to guarantee adequate load-carrying capacity.

### 5.5.7 Spot, plug and slot welds

Arc welded plug and spot welds are illustrated in Fig. 5.17. Both the TIG and MIG processes are capable of fully penetrating 2–3 mm through the upper sheet of a lap type joint to provide an acceptable weld. Laser and

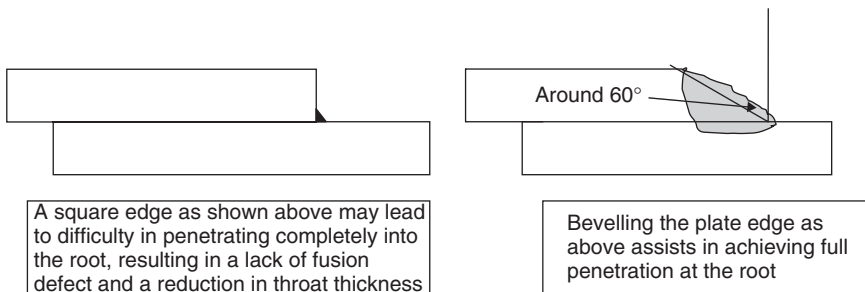

5.16 Bevelling the plate edge in a lap joint to improve penetration.

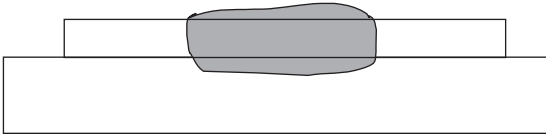

5.17 Plug and spot welds using TIG or MIG welding.

electron beam welding are capable of spot and ‘stake’ welding through a substantial plate thickness, in the case of electron beam up to 200 mm.

TIG welding tends to be confined to thin sheet, less than 2 mm thick, and finds only a very limited application in production. The bulk of spot welding is performed using MIG welding and is covered in greater detail in Chapter 7. The designer must be aware, however, of the variable quality of the spot weld which results in low strength and poor fatigue performance. The high restraint inherent in this weld form almost always results in distortion, particularly when the welds are close pitched, and may produce hot cracks in the HAZ. These features limit the applications of spot welding.

Plug welding is similar to spot welding except that the upper plate is cut to provide a hole which is either completely filled with weld metal or is fillet welded around its rim. This type of weld suffers from the same problems of variable quality and inadequate strength as do the spot welds. They both tend to be avoided when structural integrity is required.

The slot weld is rather more useful in a structural application than the spot or plug weld since there is a reasonable length of weld to be deposited. This permits a stable weld pool to be established and a sound joint to be made. The weld may be a single pass completely filling the slot or it may be fillet welded both sides. For best quality the start and stop positions should be on the upper plate, clear of the slot. Fillet welded slots are preferred when the plate thickness exceeds 5 mm. The strength of a slot weld is determined by the shear strength of the weld deposit.

## 5.6 Distortion

Residual stress due to heating and cooling of the HAZs and the contraction of the weld metal as it cools from a molten state to ambient temperature is an unavoidable feature of welded joints. The stress deriving from this shrinkage results in distortion. This distortion may be localised, evenly distributed and acceptable or may render the entire structure unfit for its purpose. In a ship’s hull, for instance, buckling of the hull plates can induce turbulence and increase drag; in piping it can restrict fluid flow; and in architectural applications it can be aesthetically unacceptable.

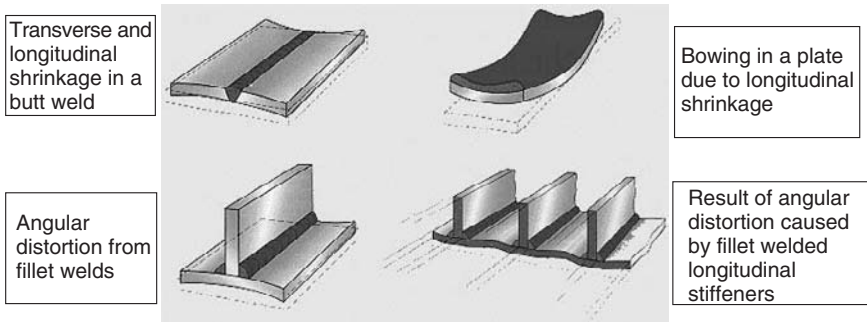

5.18 Longitudinal, transverse and angular distortion. Courtesy of TWI Ltd.

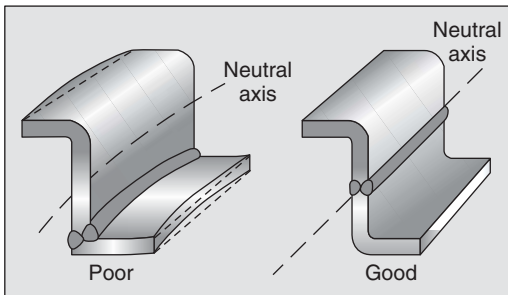

5.19 Welding around the neutral axis. Courtesy of TWI Ltd.

Distortion can appear as longitudinal shrinkage, transverse shrinkage, angular distortion, bowing or buckling. The various forms are shown in Fig. 5.18. The amount of distortion is affected by the heat input from the welding process, the welding sequence, joint design, the amount the joint is restrained, stresses in the parent metal and its physical characteristics.

Although the coefficient of thermal expansion of aluminium is about twice that of steel, its high thermal conductivity means that temperature gradients are less severe. However, the change that occurs when the weld metal solidifies is around a 5% volume shrinkage, compared with a 3% reduction in steel. The net result is that distortion in aluminium is somewhat greater than would be expected in a similar steel structure. If the metal is in a highly stressed state, such as being cold worked, this will also lead to greater distortion as these stresses are released by the heat of welding.

The measures that can be taken to minimise the problem are similar to those that would be used for steel:

- **Weld on or very close to the neutral axis.**
- **Balance the welds about the neutral axis of the component** (Fig. 5.19).

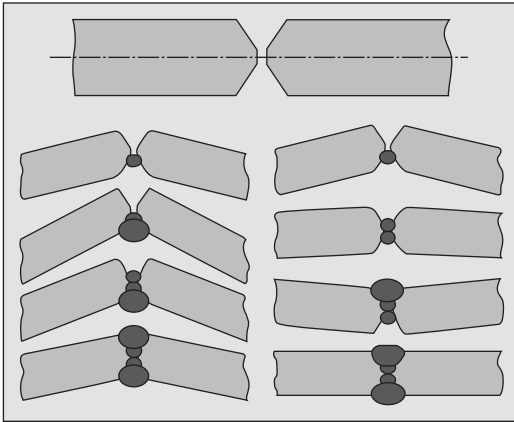

5.20 Balanced welding in a butt weld. Courtesy of TWI Ltd.

- Where appropriate **use a double-V preparation** and balance the welding about the plate centre line (Fig. 5.20).
- **Use the lowest heat input process and welding parameters**, consistent with achieving the required quality. Of the fusion welding processes the power beam processes – electron beam or laser welding – will give the least distortion.
- **Use the fewest number of weld passes to fill the joint**. This implies that a high heat input process will result in less distortion than a low heat input process. This may seem to be in conflict with the point above but it should be remembered that it is the *total* heat input to the joint that is significant. The sum of heat inputs from a large number of small passes will result in a higher total heat input than that from a small number of large beads for the same volume of weld metal. TIG welding, for instance, will almost always give more distortion than MIG welding the same component.
- On long welds, **weld from the centre towards the ends**. On items such as beams this will approximately halve the amount of bowing that would be expected if the beam was welded by starting at one end and welding through to the opposite end.
- **Use a ‘back-step’ sequence**, i.e. weld from a cold section of joint towards a hot section already welded (Fig. 5.21).
- **Break the construction down into sub-assemblies**, weld the individual sub-assemblies and assemble the complete item, balancing any distortion from the individual items to minimise the overall distortion.
- **Preset the components** (Fig. 5.22). If the amount of distortion is known or can be predicted, the items can be assembled and offset by the amount of expected distortion. On completion of welding the distortion

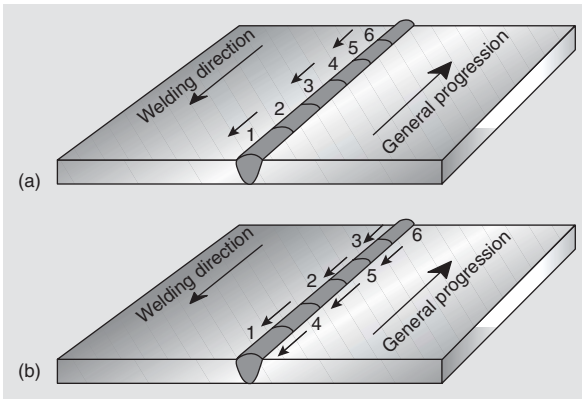

5.21 Backstep welding. Courtesy of TWI Ltd.

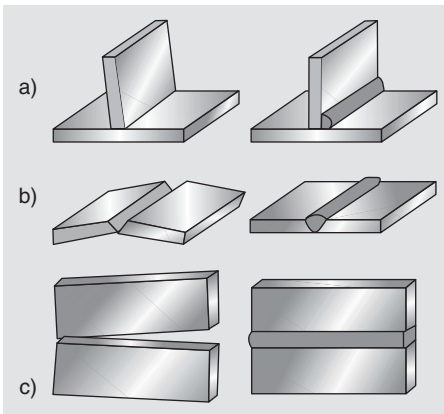

5.22 Presetting of components before welding. Courtesy of TWI Ltd.

has been used to pull the items to within tolerance. This technique is most easily used to cope with angular distortion on plates.

- **Use automatic welding.** This may enable faster travel speeds to be used and hence lower heat input to be achieved. Mechanised/automatic welding will also give more consistent distortion which enables the technique of pre-setting components to be used with greater confidence.
- **Use a planned welding sequence.** This is of use on fabrications such as lattice beams where a planned sequence can be of great benefit. The precise sequence to minimise distortion will vary from assembly to assembly and is best designed from experience. Staggered welds, back step and skip welding can also be employed.
- **Use adequate tack welds.** In a butt joint the contraction of the solidifying weld metal tends to pull together the two edges (Fig. 5.22). With thin

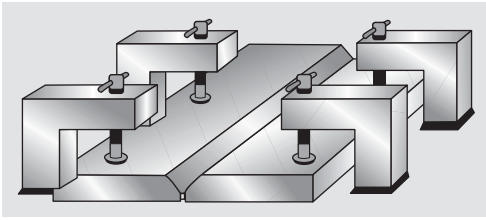

5.23 Jigging of plate to maintain flatness. Courtesy of TWI Ltd.

sheets this can result in the edges riding up over each other, requiring the tack welds to be more closely pitched. The length of tack welds should be in the region of 8 times the component thickness and spaced at intervals not greater than 35 times the thickness. They must be made with the same procedure and with as much care as the main weld. Tacks are expected to carry the assembly stresses and can therefore experience high loads that may well cause cracking problems. Incorporation of cracked tacks in the constructional weld will be an expensive problem to eliminate!

- **Ensure that the joint fit-up is accurate.** This is perhaps one aspect where the importance cannot be over-emphasised. Large root gaps, for instance, will always result in large amounts of distortion as the root weld metal contracts.
- **Do not over-weld** and avoid the use of wide bevel angles, large root gaps and large amounts of excess metal. Fillet welds should be as small as permitted by design – for example, an 8mm leg length fillet weld contains over 80% more weld metal than a 6mm leg length fillet. It is worth remembering that not only does excess weld metal increase distortion, it also costs a lot of money to deposit it!
- **Use jigs and fixtures** (Fig. 5.23), to hold and retain the components in the correct alignment. The use of rigid restraints will give increased levels of residual stress and may increase the risk of cracking. Jigs need to be designed to provide good access for welding, to be rigid and robust, to be foolproof in use and to be well maintained to ensure that wear is taken into account and tolerances are achieved.

## 5.7 Rectification of distortion

If the measures listed above are not effective, remedial measures to rectify the distortion will be necessary. These may be based upon those used for steel but great care needs to be exercised if such techniques are used. The most effective methods are those that use some form of mechanical working or stretching as these will not significantly affect the mechanical properties

of the base materials. Longitudinal bow in welded beams should preferably be done cold by pressing, and buckled plate may be pressed flat.

As a last resort, local spot or line heating may be used to heat-shrink items that have been distorted by the welding of, for instance, stiffeners. Some examples of how these techniques can be applied are illustrated in Fig. 5.24. The high thermal conductivity of aluminium means that local heating with an oxy-gas torch is not very effective. If this technique is to be used then electric induction heating is the most effective method of introducing sufficient heat into the component.

If heat must be used then this should not exceed 400 °C for the non-heat treatable alloys. Remember, though, that temperatures over 250 °C will produce full softening in the alloy if it is in the work-hardened condition. The age-hardened heat-treated alloys should not be heated to more than 150 °C as this will cause softening due to overageing of the precipitates.

Whenever these techniques are used then reference must be made to the design engineer to ensure that the potential loss of strength is taken into account.

## 5.8 Fatigue strength of welded joints

Fatigue, as the name suggests, is a failure mechanism where the component fails after a period of time in service where it sees a repetitive cyclic stress. Failure may occur even if this stress is substantially below the yield strength of the metal as the other factor in causing failure is the number of stress cycles that the component experiences. Failure always occurs normal to the principal applied stress and the fracture surface is characterised by so-called 'beach marking' where changes in the stress level give different rates of crack propagation. This gives the surface a rippled appearance similar to a beach when the tide has ebbed away. The rate of crack propagation is proportional to the stress range and the crack length. Cracks in the early stages of growth tend to be very small and to grow slowly, making it easy for them to be missed during in-service inspection.

To be able to predict the fatigue life of a structure the designer needs accurate details of the full service loading conditions and accurate fatigue data on the performance of the component parts of the structure. The most common sites for initiation are weld toes, both root and face, drilled holes, machined corners and threaded holes. Of these sites the most significant are welds. Since welding has such a significant effect on fatigue life it will be necessary to specify welding details and controls rather more closely than for a statically loaded structure. This will, inevitably, have an effect on the cost of fabrication.

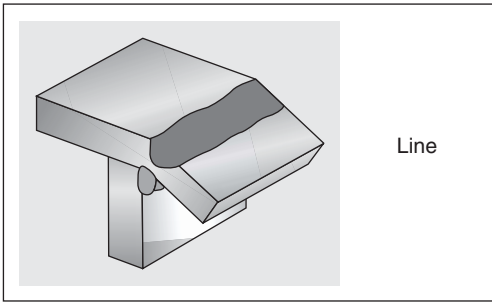

(a)

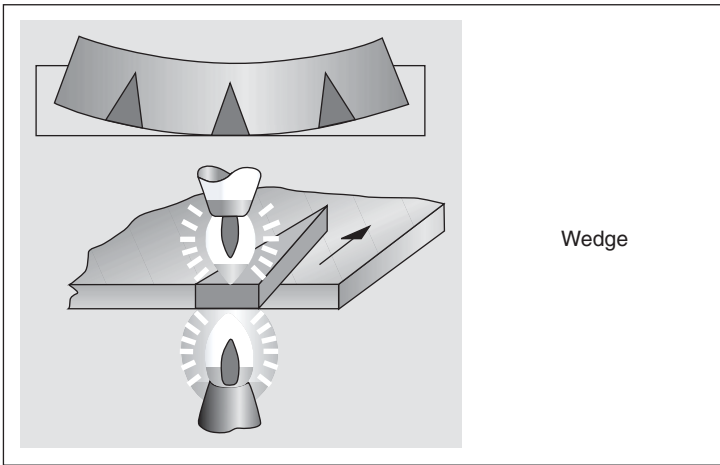

(b)

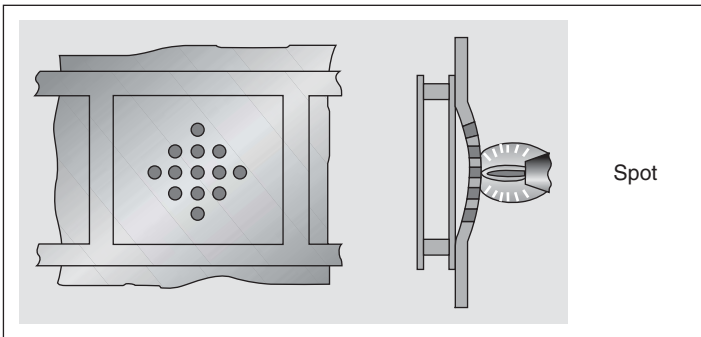

(c)

5.24 Rectification of distortion by (a) line, (b) wedge and (c) spot heating. Courtesy of TWI Ltd.



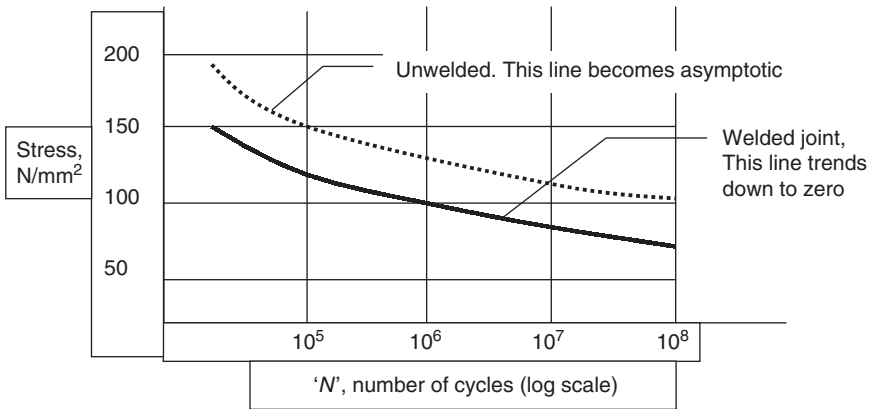

5.25 Stress/no. of cycles curve for alloy 5083.

Fatigue performance can be represented graphically on an  $S/N$  curve where 'S' is the stress and 'N' the number of cycles to failure. For unwelded components a *fatigue limit* is reached where below a certain stress failure will not occur, irrespective of the number of cycles of stress it sees. A welded joint, however, does not exhibit a fatigue limit – failure will always occur if enough stress cycles are applied. These points are illustrated in the  $S/N$  curve in Fig. 5.25.

Welding results in a substantial reduction in the fatigue life and an elimination of the fatigue limit. This is such a dominant effect that there is little difference in fatigue life between the various alloys and tensile strength in this context is, to a great extent, irrelevant. The presence of welding defects will have an additional adverse effect, particularly those defects that may be classified as planar. Abrupt changes in section, notches and corners all reduce the fatigue life. Poorly shaped welds where there is a poor toe blend with the excess weld metal meeting the parent metal at a sharp angle (see the convex fillet in Fig. 5.7 as an example) are significant stress raisers. For the best fatigue performance the welds should be smoothly blended with no abrupt changes on section.

The corollary of this is that the form and shape of the weld will have a major effect on fatigue performance. Many specifications categorise the various weld forms and the direction of loading with respect to the fatigue life as shown in Table 5.1 parts a and b.

Apart from the need to ensure that the welds are smooth and well blended the orientation of the welded item to the principal stress needs to be taken into account. Fatigue improvement techniques comprise, firstly, eliminating the weld if possible or moving it to an area of lower stress. Redesign to a joint type with a higher category should be considered. If this

Table 5.1a Fatigue classification of welded details

Description of detail	Explanatory comments	Examples showing crack sites	BS 8118 Classification	BS 5500 Classification
<b>Transverse butt weld</b>				
	Weld machined flush		42	D
	As welded with good profile, weld blends smoothly with the parent metal, eg automatic weld		35	D
	Less desirable profile, welds with peaky profile, multiple stop/starts		29	E
	Backing strip weld without tack welds, cracking from root		24	F

T-joint butt weld – full penetration

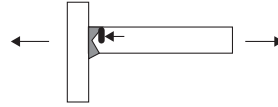

24

F

Butt weld – partial penetration.

Fatigue life determined on weld throat



14

W

### Loadcarrying fillet welds

T- or cruciform joints made with fillet welds

Cracking may be at the weld toe or in the weld throat

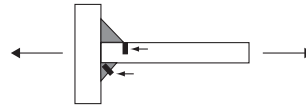

20

F2 if plate stress, W if weld throat stress

### Non-loadcarrying attachments – butt or fillet welds

Attachments not closer than 10mm from edge of stressed member

Cracking starts at the weld toe.

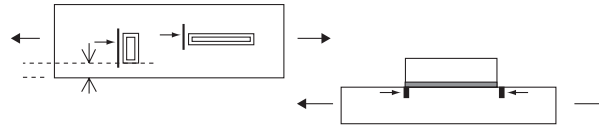

24

F

As above but within 10mm of edge of stressed member

Cracking starts at weld toe.



20

G

Table 5.1a (cont.)

Description of detail	Explanatory comments	Examples showing crack sites	BS 8118 Classification	BS 5500 Classification
Fillet or butt welded nodal joint	Calculate peak stresses acting on the joint		24 (depends on loading regime)	F or W
Fillet and partial penetration butt welds in longitudinal shear	Weld throat is used to calculate stress		43 (automatic welds) 35 (multiple stop/starts)	W

Table 5.1b Fatigue life prediction for welded items from BS 8118



cannot be done then thickening the component will reduce the stress experienced by the weld. The fatigue life of the weld can be improved by inducing compressive stresses at the toe of the weld. Overstressing the joint or hammer peening the weld toe will both do this, although great care needs to be taken that an over-enthusiastic application of either technique does not introduce defects. Dressing of the weld toes has been found to be an effective method but, once again, over-enthusiastic grinding can reduce rather than improve fatigue life. If the weld toes are ground this should be carried out by fully trained personnel. Grinding should be performed transverse to the weld toes in order that the grinding marks are parallel with the principal stress.

## 6.1 Introduction

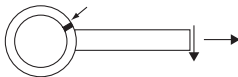
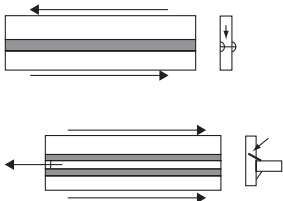
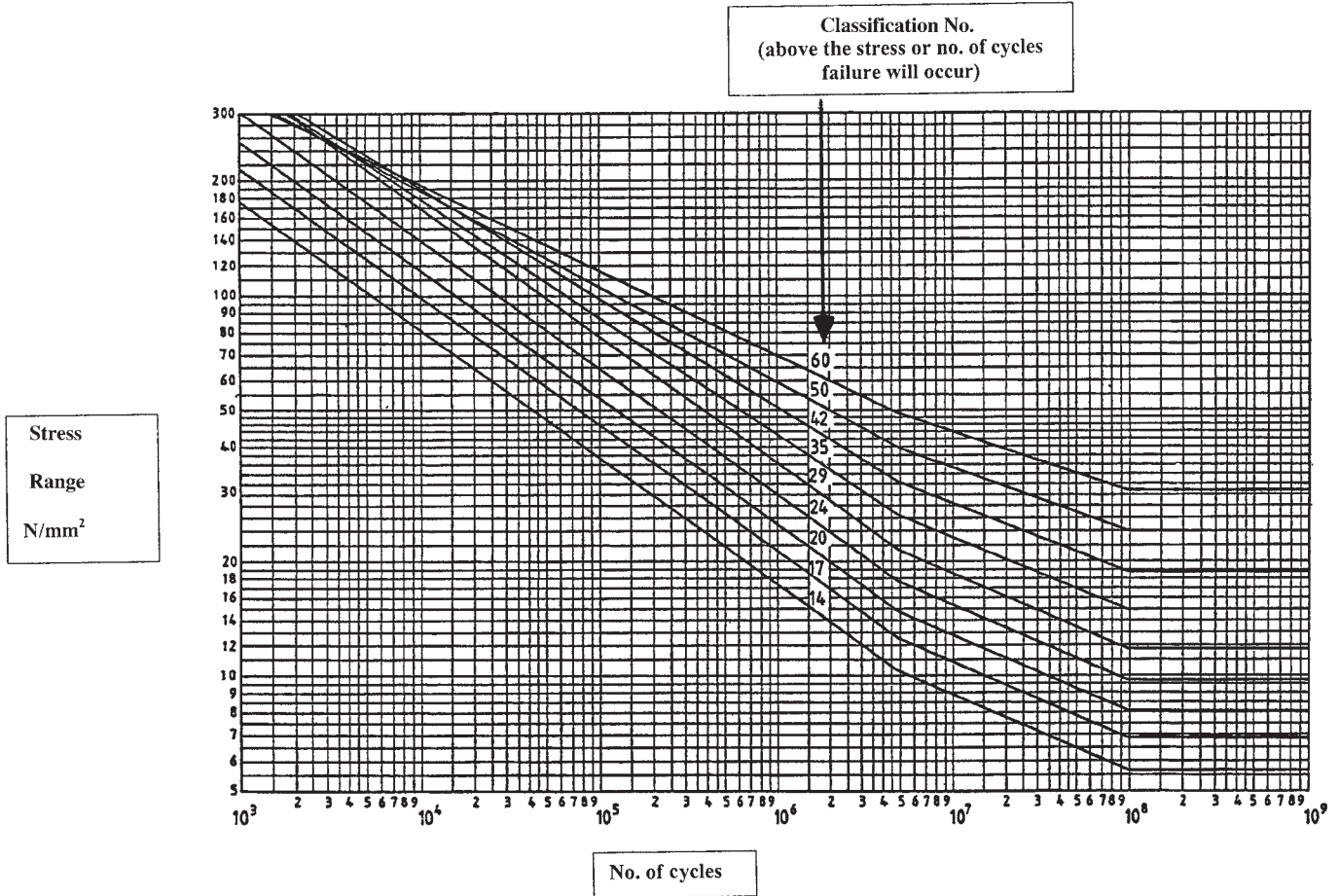
Tungsten arc inert gas shielded welding, EN process number 144 abbreviated to TIG, TAGS or GTAW (USA), is an arc welding process that uses a non-consumable tungsten electrode and an inert gas shield to protect the electrode, arc column and weld pool, as illustrated in Fig. 6.1. The welding arc acts as a heat source only and the welding engineer has the choice of whether or not to add a filler wire. The weld pool is easily controlled such that unbacked root passes can be made, the arc is stable at very low welding currents enabling thin components to be welded and the process produces very good quality weld metal, although highly skilled welders are required for the best results. It has a lower travel speed and lower filler metal deposition rate than MIG welding, making it less cost effective in some situations.

TIG tends to be limited to the thinner gauges of aluminium, up to perhaps 6mm in thickness. It has a shallower penetration into the parent metal than MIG and difficulty is sometimes encountered penetrating into corners and into the root of fillet welds. Recommended weld preparations taken from BS 3019 'TIG Welding of Aluminium' are given in Table 6.1.

## 6.2 Process principles

The basic equipment for TIG welding comprises a power source, a welding torch, a supply of an inert shield gas, a supply of filler wire and perhaps a water cooling system. A typical assembly of equipment is illustrated in Fig. 6.2.

For welding most materials the TIG process conventionally uses direct current with the electrode connected to the negative pole of the power source, DCEN. As discussed in Chapter 3 welding on this polarity does not give efficient oxide removal. A further feature of the gas shielded arc welding processes is that the bulk of the heat is generated at the positive pole. TIG welding with the electrode connected to the positive pole, DCEP,

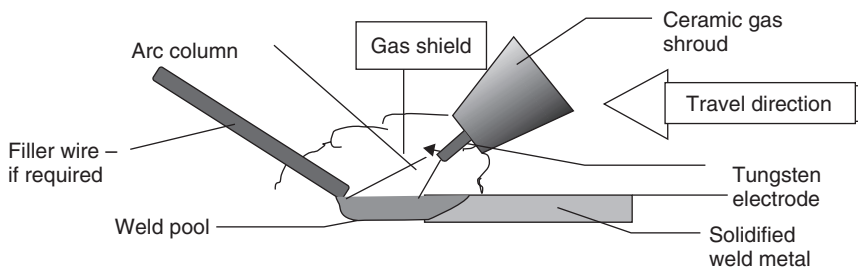

6.1 Schematic of the TIG welding process.

Table 6.1 Suggested welding preparations for TIG welding from BS 3019

Thickness (mm)	Edge preparation	Remarks
20 swg = 0.9 mm and 16 swg = 1.6 mm		Flanging should be used only where square edge close butt welds are impracticable
3.8 mm		Where a backing bar cannot be used, welding from both sides is recommended
4.8 mm		
6.4 mm		If no backing bar is used, it is good practice to chip back to sound metal and add sealing run
9.5 mm		(a) If no backing bar is used, chip back to sound metal and add sealing run (b) Chip back first run to sound metal before welding underside

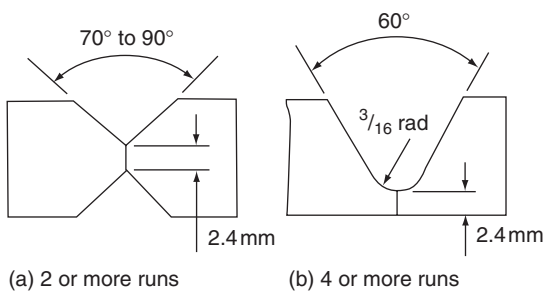
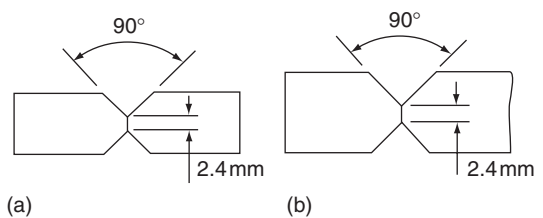
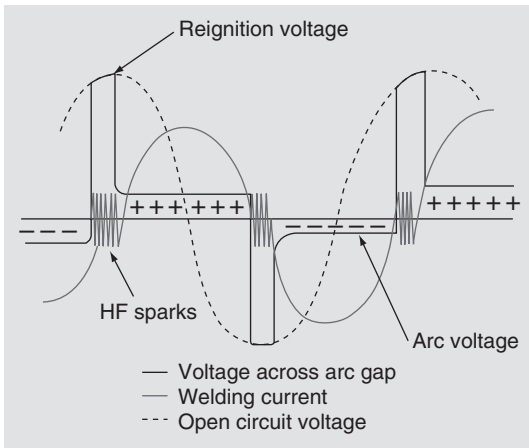

Table 6.1 (cont.)

Thickness (mm)	Edge preparation	Remarks
12.7 mm	 <p>(a) 2 or more runs</p> <p>(b) 4 or more runs</p>	<p>(a) Chip back first run to sound metal before welding underside. Preheating may be necessary</p> <p>(b) Chip back first run to sound metal and add sealing run. Preheating may be necessary</p>
(a) 4.8–6.4 mm (b) Over 6.4–12.7 mm	 <p>(a)</p> <p>(b)</p>	<p>Preparation for vertical butt welds using double operator technique. One pass only required</p>



6.2 Manual DC-ve TIG welding repair of aluminium castings using helium shielding gas. Courtesy of TPS-Fronius Ltd.



6.3 HF current and its effect on voltage and current.

results in overheating and melting of the electrode. Manual TIG welding of aluminium is therefore normally performed using alternating current, AC, where oxide film removal takes place on the electrode positive half cycle and electrode cooling and weld bead penetration on the electrode negative half cycle of the AC sine wave. The arc is extinguished and reignited every half cycle as the arc current passes through zero, on a 50 Hz power supply requiring this to occur 100 times per second, twice on each power cycle. To achieve instant arc reignition a high-frequency (HF), high-voltage (9–15 000 V) current is applied to the arc, bridging the arc gap with a continuous discharge. This ionises the gas in the arc gap, enabling the welding arc to reignite with a minimum delay (Fig. 6.3). This is particularly important on the DCEP half cycle.

Aluminium is a poor emitter of electrons, meaning that it is more difficult to reignite the arc on the electrode positive half-cycle. If there is any delay in reignition then less current flows on the positive half cycle than on the negative half cycle. This is termed *partial rectification* and can eventually lead to *full rectification* where no current flows on the positive half cycle. The arc becomes unstable, the cleaning action is lost and a direct current component may be produced in the secondary circuit of the power source, leading to overheating of the transformer. This is prevented on older power sources by providing an opposing current from storage batteries and in more modern equipment by inserting blocking condensers in the power source circuit.

The HF current is operating continuously when the arc is burning in the AC-TIG process. An important word of caution relates to this – the HF current can track into other equipment in the vicinity of the arc and

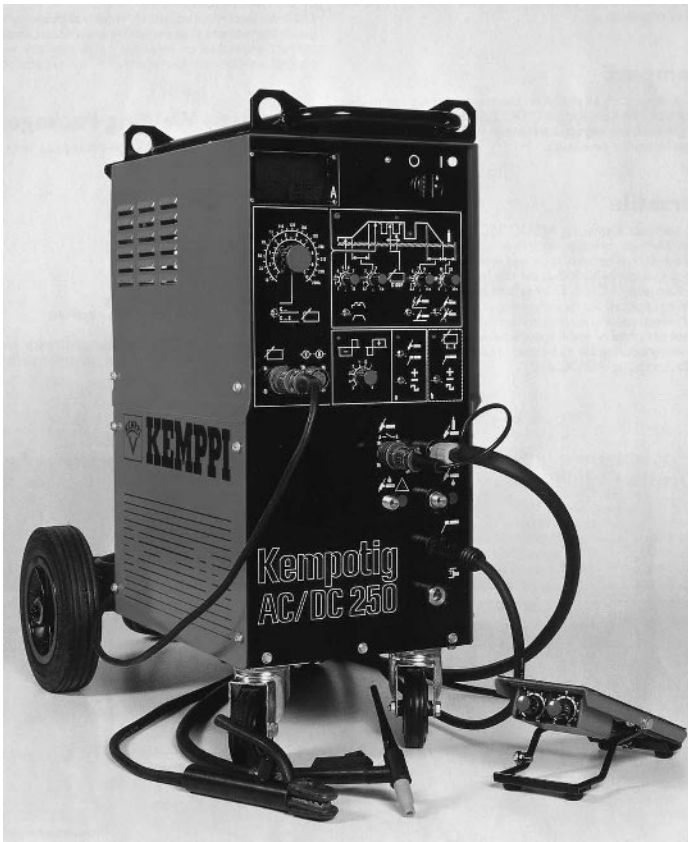

6.4 Inverter-based multi-function MMA/TIG power source capable of providing square wave AC for the welding of aluminium. Courtesy of Kemppi (UK) Ltd.

can seriously damage electronic circuits, can cause malfunctions and uncontrolled movements of robotic systems and NC machines and can affect the functioning of telephones and computer networks. Where HF current is used precautions must be taken to prevent damage by adequate shielding of equipment and electronic circuits, perhaps by the use of a Faraday cage.

### 6.2.1 Square wave power sources

The most modern equipment (Fig. 6.4) uses solid state circuitry and is capable of providing a square wave AC current rather than the sinusoidal wave form of the older equipment. These power sources can be adjusted to vary the wave frequency and the balance of positive and negative current

by shortening or extending the length of time spent on the positive or negative half cycle. The latest inverter-based units provide a high degree of control with the electrode negative duration time capable of being adjusted from 50% to 90% of the cycle. Increasing the frequency results in a more focused arc, increasing penetration, enabling faster travel speeds to be used and reducing distortion. Increasing the electrode negative portion of the cycle will give similar results of increased penetration and faster travel speed although the cathodic cleaning effect will be reduced. Biasing the square wave more towards the electrode positive half cycle will reduce penetration, useful when welding thin materials, and will widen the bead profile.

Another very important difference between older units and the inverter-based power sources is that the square wave cycle passes through the zero welding current point many times faster than with a sinusoidal wave. It is possible to dispense with continuous HF current for arc stabilisation, removing the risks of damaging sensitive electronic equipment. High frequency will still be needed to initiate the arc, however, so a small risk remains. The lack of continuous high frequency may also result in an unstable arc on very clean, etched surfaces or on the weld metal. Inverter power sources are also capable of overcoming a problem encountered when using two arcs close together. Welding current can track from one power source to the other, damaging the circuitry. With the very latest equipment the two arcs are matched.

Square wave power sources have a further advantage in that tungsten 'spitting', where the electrode tip spalls off and contaminates the weld pool, can be reduced. Reducing the electrode positive portion will reduce the overheating that causes tungsten spitting.

### 6.2.2 Shielding gas

The preferred gas for the AC-TIG welding of aluminium is argon, although helium and argon-helium mixtures may be used. Argon gives a wide, shallow penetration weld bead but will leave the weld bright and silvery in appearance. The easiest arc ignition and most stable arc will also be achieved with argon. Typical butt welds in 3 mm and 6 mm plate are illustrated in Fig. 6.5 and a fillet weld in 6 mm thick plate is shown in Fig. 6.6. A table of suggested welding parameters for use with argon as a shield gas is included as Table 6.2. Typical current ranges for a range of plate thicknesses are illustrated graphically for butt welds in Fig. 6.7 and for fillet welds in Fig. 6.8.

Helium increases arc voltage with the effect of constricting the arc, increasing penetration but making arc ignition more difficult, and adversely affecting arc stability. Some of the modern welding power sources are equipped with a facility to start the weld with argon and, once a stable arc

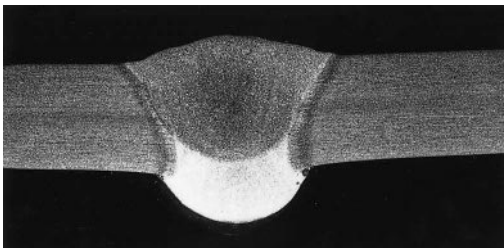
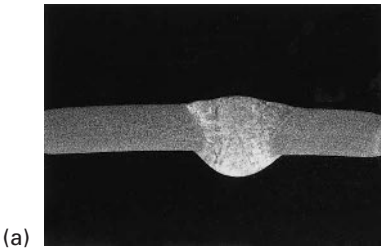

(a) (b)

6.5 AC-TIG argon shielded (a) unbacked 3mm sheet, single pass, flat position; (b) unbacked 6mm thick plate, two pass, flat position.

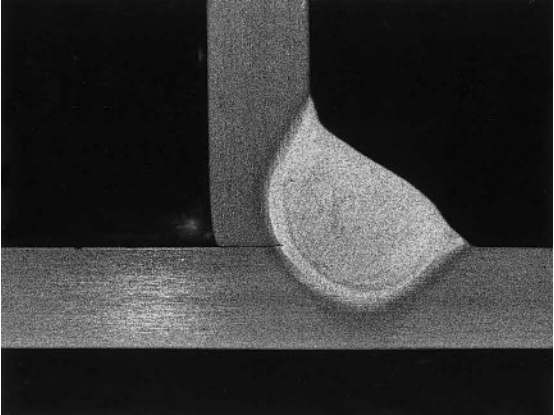

6.6 AC-TIG argon shielded, 6mm thick plate, single pass, horizontal-vertical.

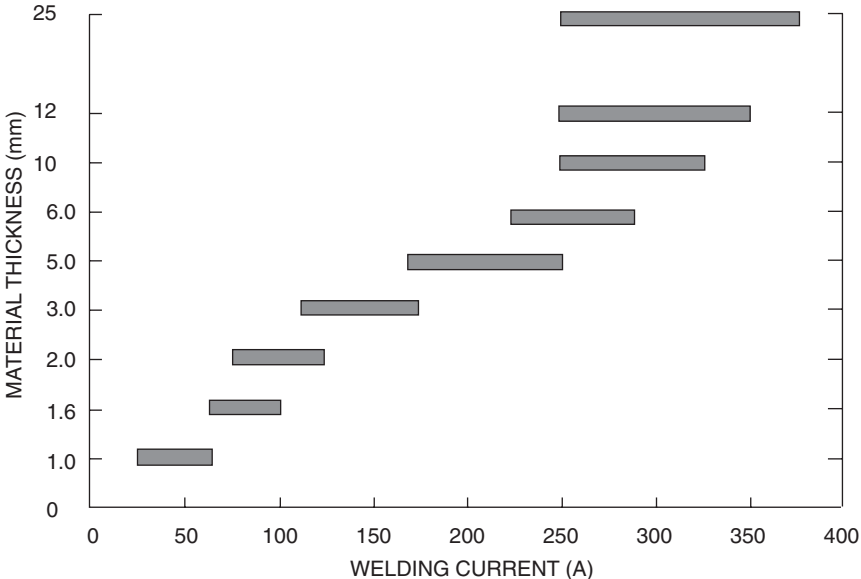

6.7 Typical TIG current ranges for various material thicknesses.

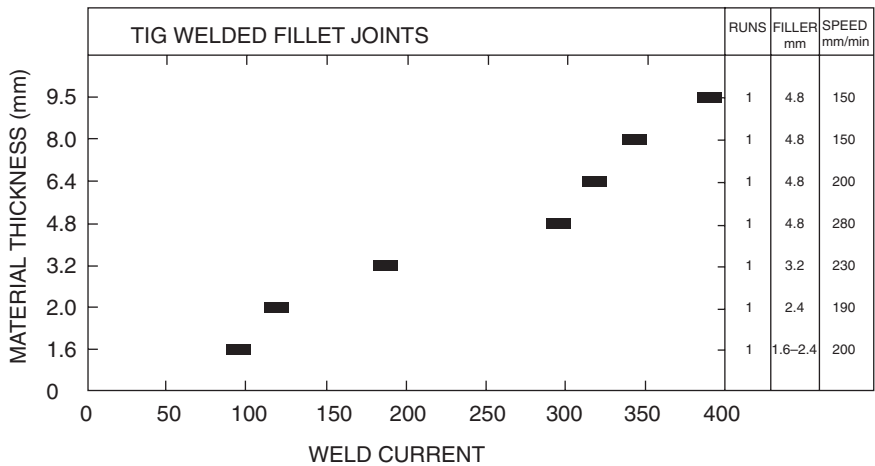

6.8 Typical TIG welding parameters for fillet welding.

Table 6.2 Suggested welding parameters – argon gas shielding

Thickness (mm)	Joint type	Root gap (mm)	Current (A)	No. of passes	Filler diam. (mm)	Travel speed (mm/min)	Nozzle diam. (mm)
0.8	sq. butt	nil	55	1	1.6	300	9.5
1.2	sq. butt	nil	100	1	2.4	400	9.5
1.5	sq. butt	0.8	130	1	2.4	470	9.5
1.5	fillet		100	1	2.4	250	9.5
2	sq. butt	0.8	160	1	3.2	380	9.5
2.5	sq. butt	0.8	170	1	3.2	300	9.5
2.5	fillet		140	1	3.2	250	9.5
3.2	sq. butt	0.8	180	1	3.2	300	12.7
3.2	fillet		175	1	3.2	300	12.7
5	sq. butt	1.6	250	1	4.8	200	12.7
5	fillet		240	1	4.8	250	12.7
6.5	70 V-butt	nil	320	1	4.8	150	12.7
6.5	fillet		290	1	4.8	250	12.7
8	70 V-butt	nil	340	2	4.8	165	12.7
10	70 V-butt	nil	350	2	6.4	180	12.7
10	fillet		370	2	6.4	250	16

1. The conditions shown are for the PA (flat) position. A reduction in current of around 10% should give acceptable parameters for other positions.
2. The thickness is limited to 10mm. Above this the TIG process is rarely used because of economic considerations.

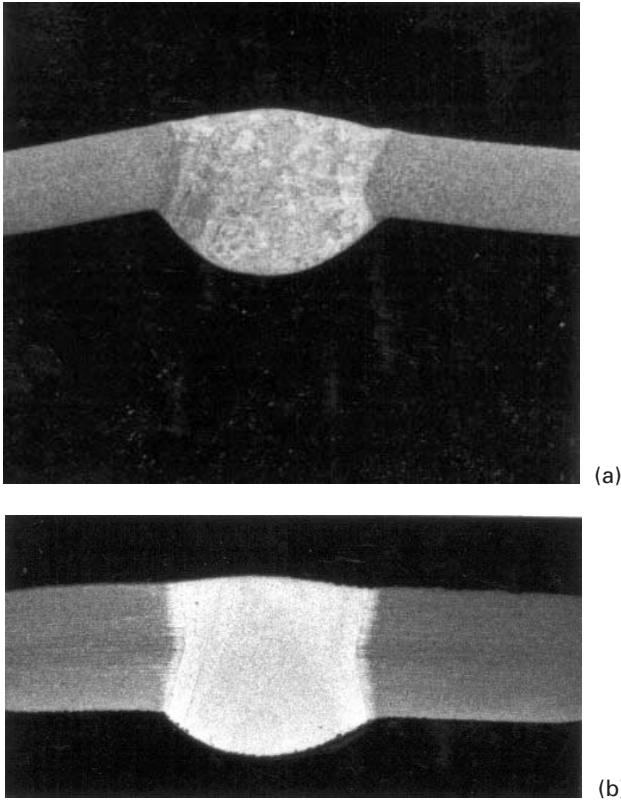

6.9 DC-TIG helium shielded (a) unbacked 3mm thick plate, single pass, flat position; (b) unbacked 6mm thick plate, single pass, flat position.

is established, for an automatic change-over to helium to be made. For comparison purposes with the argon shielded welds typical cross-sections of butt welds in 3mm and 6mm thick plate and a fillet weld in 6mm thick plate are shown in Fig. 6.9 and Fig. 6.10. In the UK helium is a more expensive gas than argon – some five to six times more – and provides little or no arc cleaning action. Indeed, in some circumstances, the use of helium can result in ‘soot’ being deposited in the HAZ and although this may normally be removed by wire brushing, it can be difficult to remove. For these reasons 100% pure helium is rarely used in manual AC-TIG welding.

The addition of argon to helium improves arc striking and arc stability. Travel speeds and penetration will be less than with pure helium but greater than with argon. It is possible to control bead width and penetration by varying the amount of argon in the mixture. The most popular mixture in the UK is 25% helium in argon.

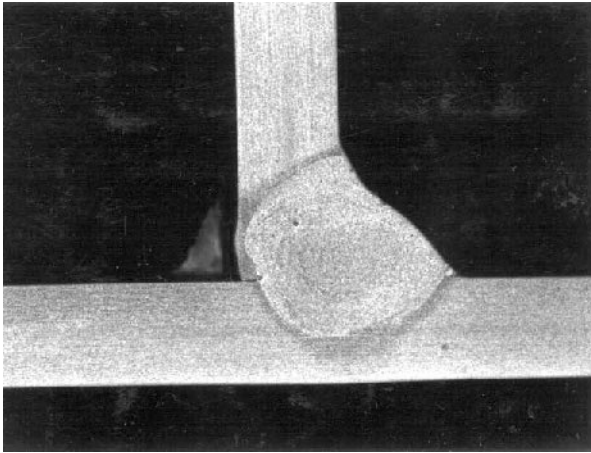

6.10 DC-TIG helium shielded, unbacked 6mm thick plate, single pass, horizontal-vertical.

The power source controls should provide for both pre-flow and post-flow of the shield gas. A pre-flow is used to purge the hoses and the torch and to protect the electrode when the arc is established. Maintaining the flow of gas when the weld is terminated is also necessary to protect both the weld pool and the electrode from oxidation as they cool from welding temperature. Gas flow rates are important in ensuring adequate gas coverage. 'Bobbin' type flow meters are often used attached to the regulator to control flow. Any restriction between the bobbin meter and the torch means that the flow rate will not be set accurately. It is a good idea to validate meter readings by attaching a flow meter to the torch gas shroud and monitoring the flow. Flow meters are also calibrated for a specific gas and will give inaccurate readings if they are used to control the flow of other gases or gas mixtures. This is particularly important when using helium or argon-helium mixtures.

### 6.2.3 Welding torches and cables

There is a wide variety of welding torches available with torch ratings ranging from some tens of A to 450 A, the appropriate rating depending essentially on the thickness of the metal to be welded. Most of the modern torches (Fig. 6.11), are provided with current controls built into the torch handle. All but the lightest torches, i.e those rated to operate below around 200 A, are water cooled and the same water may be used to cool the power cables, enabling them to be lighter and more flexible.

Overheating of the torch can melt the brazed joints within the torch or the plastic tube that sheaths the power cable and it is important that



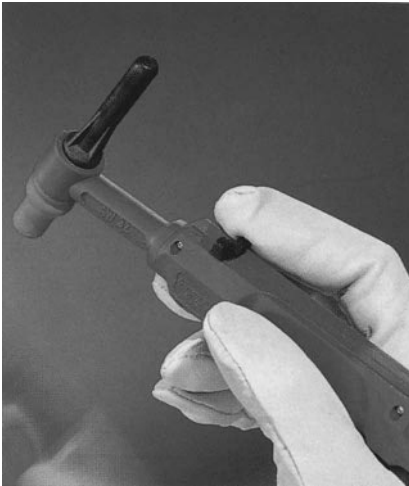

6.11 Modern TIG torch. Courtesy of TPS-Fronius.

Table 6.3 Suggested nozzle sizes and gas flow rates

Material thickness (mm)	Gas nozzle diameter (mm)	Shield gas flow rates	
		Argon (l/min)	Helium (l/min)
up to 1	9.5	3.4	7.5
1 to 3	9.5	4.5	9.5
3 to 5	12.5	5.6	11.8
5 to 9	12.5	7.0	14.2
9 to 12	16.0	8.0	16.5
12 and above	25.0	12.0	21.0

the correctly rated torch is selected for the current to be used in production. The manufacturer's rating for a torch may be based on DC-positive current and a torch rated in this way will need to be de-rated when used with AC.

Most of the torches can be fitted with either metal or ceramic gas shrouds although the ceramic shrouds are the most popular. They are, however, rather more easily damaged than the metal shrouds. Nozzle sizes for a range of thicknesses and gas flow rates are given in Table 6.3. It is recommended that a device known as a gas lens is fitted to welding torches. This is a mesh disc inserted into the torch which assists in providing a more efficient, laminar flow gas shield with better coverage. The beneficial effect of a gas lens is illustrated in Fig. 6.12.



6.12 Demonstration of laminar flow by use of gas lens. Courtesy of TWI Ltd.

#### 6.2.4 Tungsten electrodes

There are several types of electrodes available for TIG welding. These include pure tungsten and tungsten alloyed with thoria ( $\text{ThO}_2$ ) or zirconia ( $\text{ZrO}_2$ ). These compounds are added to improve the arc starting characteristics, to stabilise the arc and to extend the electrode life. Recently there has been a move towards the use of other rare earth elements such as caesium, cerium or lanthanum, which are claimed to extend the electrode life further and will reduce the radiation risk arising during the grinding of thoria containing electrodes. Zirconiated electrodes are preferred for AC-TIG welding since these have a higher melting point than either pure tungsten or thoriated tungsten electrodes and can therefore carry higher welding currents, are more resistant to contamination and are less likely to spall.

The electrode tip assumes a hemispherical shape during welding. It is important that this shape is maintained if a stable arc is to be achieved. The

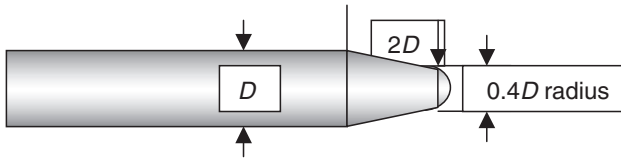

6.13 Recommended tungsten electrode shape.

Table 6.4 Recommended electrode diameters – zirconiated tungsten electrodes and argon shield gas

Tungsten electrode diameter (mm)	Current (A)
1.0	20–50
1.6	50–80
2.4	80–160
3.2	160–225
4.0	225–330
5.0	330–400
6.4	400–550

electrode tip should be lightly tapered to assist in the formation of the rounded tip as illustrated in Fig. 6.13.

Too small an electrode for the current will lead to overheating and possibly melting, resulting in tungsten contamination of the weld pool. Too large an electrode for the current will result in arc stability problems and a very wide weld pool. Electrodes are available in diameters ranging from 0.3 mm to 6.4 mm. Recommended electrode diameters and welding currents are given in Table 6.4. The electrode should not protrude from the nozzle by more than about 6 mm, although this may be extended by up to 10 mm if a gas lens is fitted to the torch. This extension can be useful if access is restricted because of the ceramic nozzle fouling on the component.

Before production welding is started it is recommended that the electrode is preheated by forming an arc on a piece of aluminium scrap. This enables the rounded tip to be formed, allows the welder to check that the electrode is performing correctly and enables the arc to be reignited on the production component with ease. If the tip becomes contaminated or is damaged in any way it should be reground and reformed as above.

Table 6.4 is for square wave AC-TIG with a balanced wave form. If the current is biased to give a greater proportion of positive current the value will need to be reduced by an amount appropriate to the amount of imbalance in the wave form. If using a conventional balanced sine wave current then these values should be reduced by around 25%.

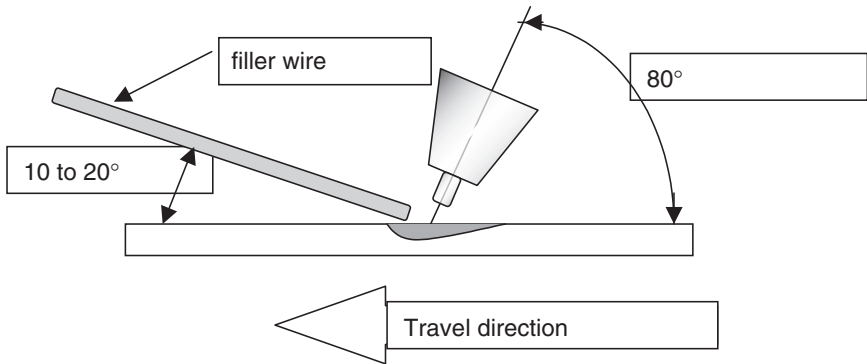

6.14 Angle of torch and wire workpiece.

## 6.2.5 Manual welding techniques

### 6.2.5.1 Torch manipulation

The welder should attempt to maintain the shortest practicable arc length. In practice this is approximately equal to the electrode diameter. If the arc is too long penetration is decreased and the risk of lack of fusion defects is increased. Undercutting, poor bead shape and excessive bead widths may also be produced. Gas shielding may also be affected with entrainment of air into the shield gas giving oxide inclusions in the weld.

The torch should be held normal to the weld but pointing forwards towards the direction of travel, at an angle of around 80°. When welding joints of unequal thickness the arc should be directed more towards the thicker side of the joint. For fillet welds the torch should bisect the angle between the two plates. Weaving of the torch may be carried out but the weave width should be restricted to the diameter of the nozzle.

### 6.2.5.2 Filler rods

The filler rod, if used, should be fed into the leading edge of the weld pool with a slow, 'dabbing' action at an angle of 10–20° (Fig. 6.14). It should not be fed directly into the arc column as this tends to cause spatter and may accidentally contaminate the electrode. A steeper angle than 10–20° restricts the welder's view of the weld pool. The tip of the filler rod should be held inside the gas shield while it is hot to prevent oxidation. As the component thickness increases the filler rod diameter increases, necessitating an increase in arc length. Bear in mind that too long an arc can cause oxide entrapment problems. A large diameter rod can also shield the material ahead of the weld pool from the cleaning action of the arc and this may also lead to oxide entrapment.

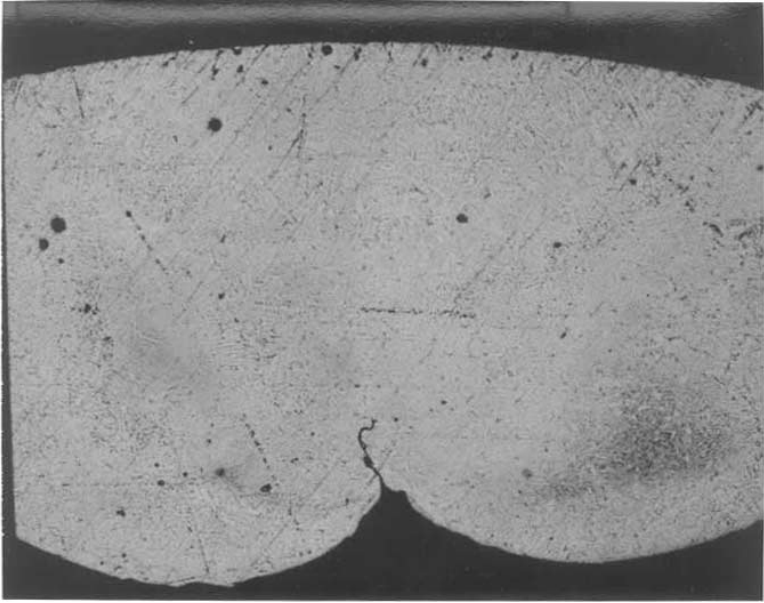

6.15 Oxide intrusion and cracking associated with suck-back.

### 6.2.5.3 Root bead penetration

It is possible to produce fully fused root beads without backing using AC-TIG. Up to 3 mm thickness the weld can be made without a weld preparation but above this a V- or U-preparation will be necessary to achieve full fusion. Root gaps should be avoided. A skilled welder will use the appearance of the weld pool to judge when a fully penetrating root bead has been produced. When full penetration has been achieved the weld pool will sink and will have a bright shiny surface. A U-preparation will make it easier for the welder to judge when this happens. In thicker material when using a V-preparation the arc tends to favour the side walls instead of acting directly on the root, sometimes leading to lack of fusion type defects. An alternative to a U-preparation that avoids this problem is to use a V-preparation with an included angle of at least  $90^\circ$ . When welding root passes in position, particularly overhead, root concavity or 'suck-back' is a problem. This requires the filler rod to be pushed into the weld pool to disrupt the oxide film and to form a convex bead.

The oxide film that causes suck-back is also responsible for a feature known colloquially as a 'baby's bottom', a very accurate description of the appearance of this root defect (Fig. 6.15). Oxides tend to migrate to the centre of the root penetration bead. When these become excessive the centre of the bead sinks to produce a deep groove along the centre line that may also be associated with hot cracking. In butt welds a very wide weld

bead caused by a large root gap or a high welding current will also contribute. This defect is particularly prevalent in corner joints in thin sheet assemblies and is caused by a failure to clean the weld preparations and the filler wire adequately. It has been found helpful to use unbalanced square wave AC to increase the arc cleaning action and pulsed square wave AC, with a heavy bias towards DC positive, has been successfully used in particularly troublesome applications.

Permanent backing strips may be used to simplify root bead control. These require a very good fit-up between the underside of the plates and the backing strip to prevent lack of fusion or suck-back type defects. To achieve good penetration into the backing strip there must be a root gap of at least 1.5 times the electrode diameter and this gap must be maintained along the full length of the component. This means that the joints must be adequately tack welded together.

#### 6.2.5.4 *Weld termination*

Controlled finishing of a weld pass is important if defects are to be avoided. Abruptly switching off the welding current can cause craters, piping (elongated pores) and cracks in the finished weld pool. When finishing the weld it is necessary to reduce the welding current gradually and to decrease the arc length as the arc fades away, adding filler rod until such times as the arc is extinguished. If a crater begins to form the arc should be briefly re-established, additional filler metal added and the arc decayed as before. On thin material the travel speed may be increased to a point at which it can be seen that the metal has ceased to melt.

### 6.2.6 DCEN helium TIG welding

Welding aluminium with the electrode connected to the negative pole can be carried out using helium as the shield gas. This gives a higher temperature arc and increased penetration compared with AC-TIG but the oxide removal action of the positive arc is absent. This means that cleaning of the item to be welded assumes even more importance than when using AC. The higher heat input and the deeper penetration means that higher travel speeds can be used and a wider range of thicknesses may be welded than with AC-TIG, although the high travel speeds do mean that the process is rarely used in a manual context but is almost entirely mechanised. Typical single pass welds using helium as the shield gas are illustrated in Fig. 6.9 (butt welds) and Fig. 6.10 (fillet weld). Note in particular the wider and more deeply penetrating fillet weld bead compared with argon shielding. Suggested welding parameters for butt and fillet welding using helium are given in Table 6.5.

Table 6.5 Suggested parameters – DC-ve helium shielded gas welding

Thickness (mm)	Joint type	Root gap /face (mm)	Current (A)	Voltage (V)	No. of passes	Filler diam. (mm)	Travel speed (mm/min)
0.8	sq. butt	nil	20	20	1	1.2	420
1	sq. butt	nil	26	20	1	1.6	420
1.5	sq. butt	nil	45	20	1	1.6	480
2.4	sq. butt	nil	80	17	1	2.4	300
2.4	fillet		130	14	1	2.4	540
3.2	sq. butt	nil	120	17	1	3.2	480
3.2	fillet		180	14	1	3.2	480
6.3	sq. butt	nil	250	14	1	4.8	180
6.3	fillet		255	14	1	4.8	360
10	90 V-butt	nil face 6	285	14	2	4.8	150
10	fillet		290	14	1	6.3	180
12.5	90 V-butt	nil face 6	310	14	2	4.8	120
12.5	fillet		315	16	2	6.3	180
20	90 double-V	nil face 5	300	17	2	4.8	120
25.4	90 double-V	nil face nil	360	19	5	6.3	60

1. Ceramic nozzle size should be 12.7 mm.

2. The parameters shown are for welding in the PA (flat) position for the butt welds and the PB (horizontal) position for the fillets.

Unlike AC-TIG where zirconiated electrodes are preferred, the best electrodes for DCEN welding are thoriated tungstens, which permit easier arc starting, maintain their tip shape longer and result in less tungsten spitting. The tip of the electrode should be tapered at an angle of  $45^\circ$  and the end blunted by grinding on a flat of about half the electrode diameter. A long tapered tip can result in shield gas turbulence, poor weld profiles and undercutting.

Wire feeding differs from that used in AC-TIG welding in that the wire tip should be fed into the weld pool by pushing the still solid wire into the pool and then withdrawing it when a sufficient amount of filler wire has been added, keeping the wire tip within the gas shield. The torch is then moved forward and a fresh weld pool established. This discontinuous method of welding assists in piercing the oxide skin on the weld pool surface and in increasing penetration. With temporary backing bars this technique enables square edge butt joints to be welded at thicknesses of up to 9mm, provided that the welder has sufficient skill. Double sided square edge butt welds can be made successfully at up to 12.5 mm thickness. Above this thickness then a 'V' or preferably a 'U' preparation needs to be used to enable

single sided unbacked butt joints to be made. It is recommended that an electrode with a fully tapered tip is used to concentrate the arc into the root of the joint when a weld preparation is to be welded.

One feature seen with helium shielded arc welding, which often gives cause for concern, is the formation of a black 'soot' along the heat affected zones of the weld. This 'soot' is not detrimental to the weld quality and can easily be removed by stainless steel wire brushing. If left in place between passes it can affect arc stability and is unsightly on a completed weld.

### **6.3 Mechanised/automatic welding**

Automation or mechanisation of the TIG process can have a number of benefits. These include the ability to use faster travel speeds, resulting in less distortion and narrower heat affected zones; the better and more consistent control of the welding parameters enables very thin sheet material to be welded; there is a greater consistency in the weld quality; and it is possible to employ operatives with a lesser degree of skill and dexterity than is required for manual welding. There are, as ever, some drawbacks to the use of mechanisation, not least of which is the need to provide the welding fixture with far more accurate and consistent weld preparations than are required by the manual welder. Accurate joint fit-up and alignment is crucial to achieving consistently high weld quality. Jigs and fixtures also need to be capable of holding the components within tight tolerances and of maintaining these tolerances as welding proceeds. As an example, autogenous welding of thin (say 3 mm) plate requires root gaps to be maintained at 0–0.025 mm and plate edges to be aligned to better than 0.05 mm if root penetration problems are to be avoided. Adding filler wire will assist in increasing the permissible tolerances but at the expense of welding speed. It is possible to develop welding procedures that will provide an acceptable unbacked root pass, but in many welding fixtures a removable backing bar is part of the clamping system. This greatly simplifies the task of setting up the joints accurately and in achieving a sound root and is to be recommended.

Although the parameters of welding current and voltage require controlling within small tolerance bands, the parameters of wire feed speed and travel speed are far more significant. Variations in wire feed speed may lead to either underfill if the feed speed slows or overfill and lack of fusion or penetration defects if the wire feed speed increases. Too slow a wire feed speed can also result in the wire 'balling back' and prevent a smooth melting of wire into the pool.

Automation or mechanisation of both AC-TIG and DCEN helium TIG welding may be achieved by adapting the manual techniques using conventional manual equipment attached to manipulating equipment such as crawler tractors. The task of mechanisation is simplified if the weld is



autogenous and a wire feed is not required, although this can be easily provided from a spool of wire fed from a cold wire feed unit. The wire should be fed into the leading edge of the weld pool at a similar angle to that used in manual welding. Both the start of the wire feeding and carriage travel should be delayed until the weld pool is well established. When ending the weld the current should be tapered down and the wire feed speed adjusted to provide crater filling.

DCEN helium TIG is ideally suited to mechanisation since full advantage can be taken of the increase in travel speed, which may be up to 10 times that of an argon shielded AC-TIG weld. It is also possible to weld thick plates, up to 18mm thick, in a single pass, square edge preparation with no filler metal, making this a very cost-effective method. The high travel speeds possible with the technique may lead to undercutting, particularly if the welding current is increased in the expectation that this will permit even higher travel speeds to be achieved. Short arc lengths are necessary when autogenous welding, typically 0.8–1.5mm, and in some circumstances the electrode tip may be below the surface of the plate with the arc force depressing the weld pool surface. Contraction during cooling will cause upsetting to occur, resulting in a local thickening of the joint and providing sufficient excess weld metal that the joint is not underfilled.

## 6.4 TIG spot and plug welding

By overlapping two plates a spot weld can be achieved by using the DCEN TIG process to fuse through the top plate and melt into the lower plate. Initial use of the process was carried out without a filler wire but hot cracking problems with the alloys meant that it was confined to pure aluminium up to 2mm thick. The development of automatic wire feeding systems capable of feeding wire into the weld pool as the weld is terminated has helped in extending the range of alloys that could be welded. Even with this improvement, however, it has been found that the critical nature of the surface condition causes welding defects such as oxide films. This means that the process does not find general use because of low strength and poor quality.

Further work has taken place using fully automated equipment and helium shield gas and with low-frequency AC. These improvements have resulted in a wider use of the process but MIG spot welding tends to be preferred as providing better and more consistent quality.

## 7.1 Introduction

The metal arc inert gas shielded process, EN process number 131, also known as MIG, MAGS or GMAW, was first used in the USA in the mid 1940s. Since those early days the process has found extensive use in a wide range of industries from automotive manufacture to cross-country pipelines. It is an arc welding process that uses a continuously fed wire both as electrode and as filler metal, the arc and the weld pool being protected by an inert gas shield. It offers the advantages of high welding speeds, smaller heat affected zones than TIG welding, excellent oxide film removal during welding and an all-positional welding capability. For these reasons MIG welding is the most widely used manual arc welding process for the joining of aluminium.

## 7.2 Process principles

The MIG welding process, illustrated in Figs. 7.1 and 7.2, as a rule uses direct current with the electrode connected to the positive pole of the power source, DC positive, or reverse polarity in the USA. As explained in Chapter 3 this results in very good oxide film removal. Recent power source developments have been successful in enabling the MIG process to be also used with AC. Most of the heat developed in the arc is generated at the positive pole, in the case of MIG welding the electrode, resulting in high wire burn-off rates and an efficient transfer of this heat into the weld pool by means of the filler wire. When welding at low welding currents the tip of the continuously fed wire may not melt sufficiently fast to maintain the arc but may dip into the weld pool and short circuit. This short circuit causes the wire to melt somewhat like an electrical fuse and the molten metal is drawn into the weld pool by surface tension effects. The arc re-establishes itself and the cycle is repeated. This is known as the *dip transfer* mode of metal transfer. Excessive spatter will be produced if the welding parameters are not correctly adjusted and the low heat input may give rise to lack-

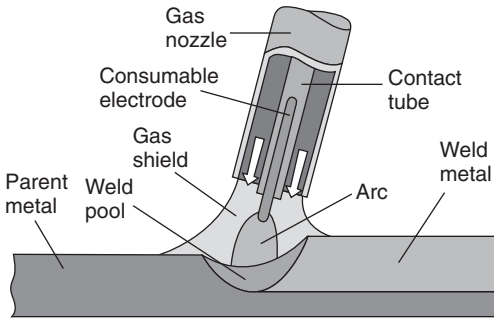

7.1 Fundamental features of the MIG process. Courtesy of TWI Ltd.



7.2 Illustrating the general arrangement of the power source, wire feeder gas cylinder and work area. Courtesy of TWI Ltd.

of-fusion defects. At higher currents the filler metal is melted from the wire tip and transferred across the arc as a spray of molten droplets, *spray transfer*. This condition gives far lower spatter levels and deeper penetration into the parent metal than dip transfer. When MIG welding aluminium the low melting point of the aluminium results in spray transfer down to relatively low welding currents, giving a spatter-free joint.

The low-current, low-heat input dip transfer process is useful for the welding of thin plate or when welding in positions other than the flat (PA)

Table 7.1 Metal transfer modes and wire diameter

Metal transfer mode	Wire diameter
Dip	0.8 mm
Pulsed	1.2 and 1.6 mm
Conventional spray	1.2 and 1.6 mm
High-current spray	1.6 mm
High-current mixed spray/globular	2.4 mm

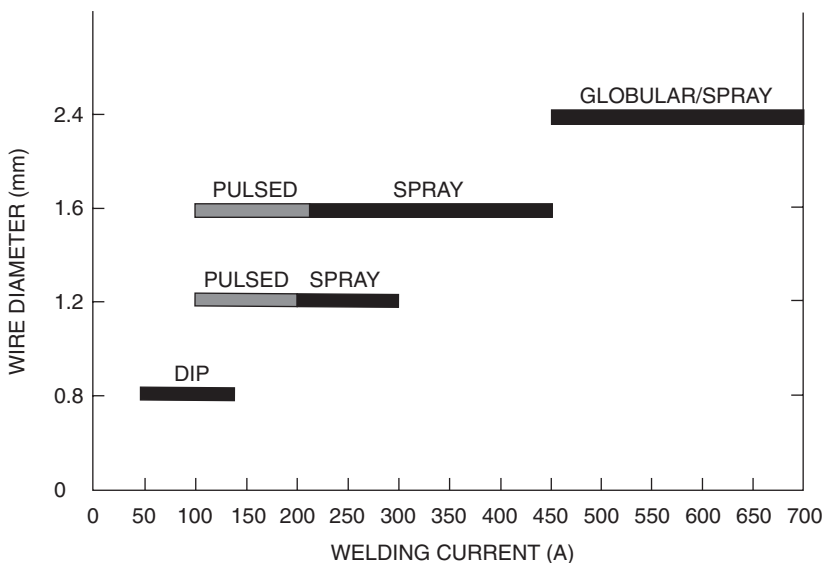

7.3 Typical welding current ranges for wire diameter and welding current.

position (see Fig. 10.3 for a definition of welding positions). It has, however, been supplanted in many applications by a pulsed current process, where a high current pulse is superimposed on a low background current at regular intervals. The background current is insufficient to melt the filler wire but the pulse of high current melts the filler metal and projects this as a spray of droplets of a controlled size across the arc, giving excellent metal transfer at low average welding currents.

Table 7.1 lists the likely and/or commonest methods of metal transfer with respect to wire diameter. Figure 7.3 illustrates the typical current ranges for a range of wire diameters.

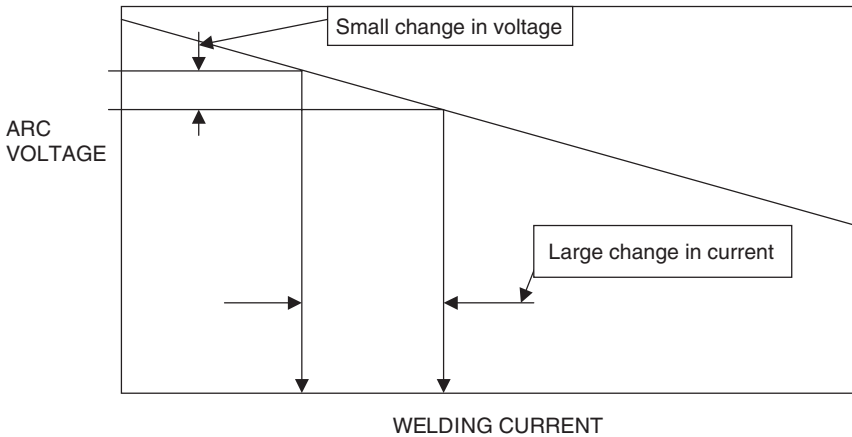

7.4 Schematic of the effect of arc voltage vs arc current. Flat characteristic power source.

### 7.2.1 Power sources

The MIG arc requires a power source that will provide direct current and with a suitable relationship established between welding current and voltage, this relationship being known as the *power source dynamic characteristic*. As mentioned above the MIG process uses a continuous wire feed and for the majority of welding operations it is important that the rate at which the wire burns off in the arc is matched by the wire feed speed. Failure to do this can result in an unstable arc and variable weld quality. To achieve this control many MIG/MAG welding power sources are designed with a *flat* or *constant voltage* characteristic. The importance of this characteristic becomes apparent when we consider what happens during manual welding. The manual welder cannot maintain a fixed invariable arc length while welding – an unsteady hand or repositioning himself during welding means that the arc length varies and this in its turn causes variations in arc voltage. When this happens with a flat characteristic power source a small increase in the arc length results in an increase in arc voltage, giving a large drop in arc current, as illustrated in Fig. 7.4. Since the wire burn-off rate is determined by the current this also decreases, the tip of the wire moves closer to the weld pool, decreasing the voltage and raising the current as it does so. The burn-off rate therefore rises, the arc length increases and we have what is termed a *self-adjusting arc* where a constant arc length and filler metal deposition rate are maintained almost irrespective of the torch movement.

During both dip and spray transfer the speed at which the power source responds to the changes in the arc length is determined by the inductance

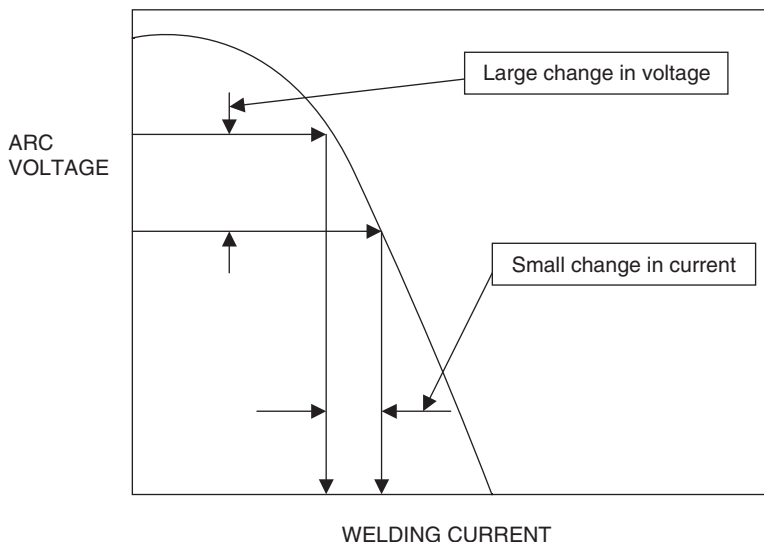

7.5 Schematic of effect of arc voltage vs arc current. Drooping characteristic power source.

in the welding circuit. This controls the rate of current rise or fall and can have a significant effect on weld quality. Insufficient inductance permits the welding current to rise extremely rapidly, giving rise to excessive spatter and burning back of the wire to the contact tip. Too high an inductance means that the wire does not melt sufficiently rapidly and the wire tip may stub into the weld pool or be pushed through the root pass to protrude from the root. It is essential therefore that the power source is adjusted for the correct amount of inductance when, for example, the wire diameter or wire feed speed is changed.

The converse of the flat characteristic power source is the *drooping characteristic* or *constant current* power source, illustrated in Fig. 7.5. This design of power source is generally used in MMA and TIG welding but it also has some advantages when MIG welding aluminium. With a drooping characteristic a large change in arc voltage results in only a small change in arc current. Heat input is therefore reasonably constant, unlike that from a flat characteristic power source arc, giving more consistent penetration.

The problem with the drooping characteristic power source when used for MIG welding is that it requires more skill on the part of the welder. With push wire feeders the soft aluminium wire can buckle within the wire feed conduit, particularly with long and flexible conduits. This results in the wire feed speed at the contact tip fluctuating and, if no action is taken, variations in the heat input to the weld. When using a flat characteristic power

source these fluctuations are compensated for by the power source and the welder may not appreciate that this is occurring – with the drooping characteristic the arc length changes and the welder may experience what are perceived as arc stability problems. If the welder is sufficiently skilled, corrective action can be taken before this results in welding defects, whereas with the flat characteristic power source the welder can produce lack of fusion or excess penetration defects unknowingly. An advantage of the drooping characteristic power source is that as the welding current and the wire feed speed are fixed the welder can employ these features to enable the wire tip to be pushed into the joint, a useful feature when making the root pass.

The drooping characteristic unit is also useful in deep weld preparations. In such joints the constant voltage power source may measure the arc voltage from the side wall, rather than from the bottom of the weld preparation, resulting in an unstable arc condition, poor bead shape and variable penetration. The same restrictions apply when welding the root pass in fillet welds where a drooping or constant current unit may give better results than the constant voltage power source. Weaving of the torch may also cause problems where the torch is moved simply by pivoting the wrist. This gives a regular increase and decrease in arc length, causing a loss of penetration at the limits of the weave with the flat characteristic power source. However, despite the apparent advantages of a drooping characteristic power source the bulk of MIG welding units in production today use a flat characteristic with consistent and acceptable results.

#### *7.2.1.1 Pulsed MIG welding*

Pulsed MIG welding was developed in the early 1960s but it was not until the late 1970s that the process began to be widely adopted on the shop floor. Prior to this date the equipment had been expensive, complicated and difficult to set up for optimum welding parameters, making it welder-unfriendly and impeding its acceptance by the most important individual in the welding workshop. Solid state electronics started to be used in welding power sources in the 1970s and ‘single knob’ control became possible with the advent of synergic logic circuits. The synergic capability enabled all of the welding parameters to be controlled from a single dial control which optimised the current peak pulse and background values, the voltage and the wire feed speed. It has also become possible to reprogramme the power source instantly when wire size, shield gas, filler metal composition, etc. are changed, simply by dialling in a programme number (Fig. 7.6). These programmes have been established by the equipment manufacturer with the optimum parameters for the application. Initially these units were expensive but the price has been steadily reduced such that they

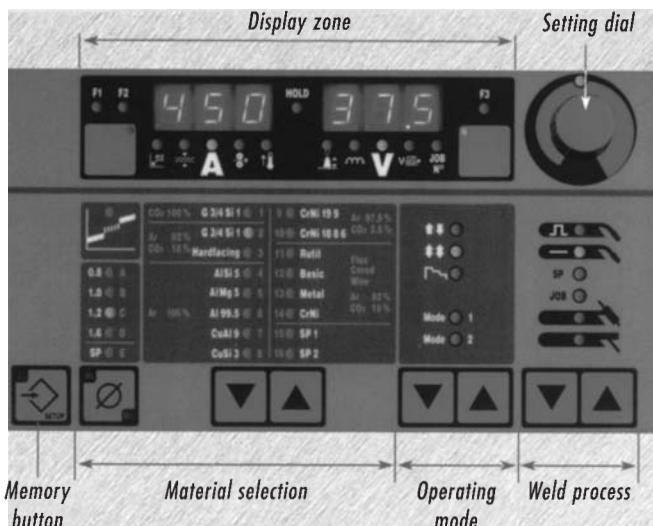

7.6 Typical modern pre-programmable control panel for synergic pulsed MIG power source. Courtesy of TPS-Fronius Ltd.

are now only marginally more costly than a conventional power source, leading to a far wider usage. The modern inverter-based units (Fig. 7.7), are also far lighter, far more energy efficient and more robust than the older units that they are replacing.

The pulsed MIG process uses a low ‘background’ current, sufficient to maintain the arc but not high enough to cause the wire to melt off. On this background current a high-current, ‘peak’ pulse is superimposed. Under optimum conditions this causes a single droplet of molten filler wire to be projected across the arc into the weld pool by spray transfer. It is thus possible to achieve spray transfer and a stable arc at low *average* welding currents. This enables very thin metals to be welded with large diameter wires where previously very thin wires, difficult to feed in soft aluminium, needed to be used. The lower currents also reduce penetration, useful when welding thin materials and also enable slower welding speeds to be used, making it easier for the welder to manipulate the torch in difficult access conditions or when welding positionally.

The use of electronic control circuitry enables arc starting to be achieved without spatter or lack of fusion defects. Some units now available will slowly advance the wire until the tip touches the workpiece, sense the short circuit, retract the wire to the correct arc length and initiate the full welding current (Fig. 7.8). Similarly, in most of these modern units a crater filling facility is built in, which automatically fades out the current when the trigger on the gun is released.





7.7 Modern 500 amp inverter-based programmable synergic pulsed MIG power source. Courtesy of TPS-Fronius Ltd.

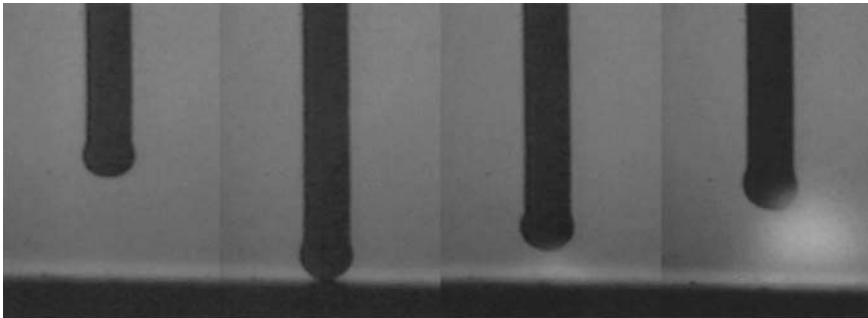

*Wirefeed forwards*

*Wirefeed stop - short-circuit recognition*

*Wirefeed backwards - pilot arc is ignited*

*Wirefeed backwards - arc length is set*

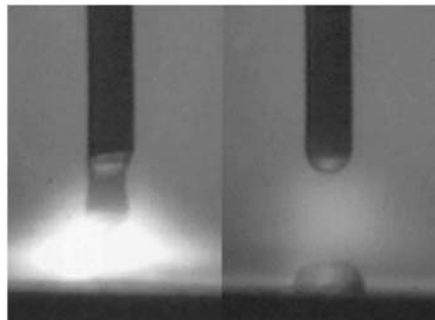

*Wirefeed forwards - ignition is complete - pulsed arc starts up*

*Metal transfer*

7.8 Programmed arc start – reducing the risk of lack of fusion defects. Courtesy of TPS-Fronius Ltd.

If you are contemplating purchasing new or replacement MIG equipment it is recommended that pulsed MIG power sources are purchased, even though they are more expensive than conventional equipment. This will give the fabrication shop a more flexible facility with a wider range of options than with the straight DC units.

#### 7.2.1.2 *Fine wire MIG*

As the name suggests the fine wire MIG process uses a fine, small diameter wire, less than 1.2 mm and as small as 0.4 mm in diameter, although wires of 0.4 and 0.6 mm in diameter need to be specially ordered from the wire drawer. Small diameter wires are notoriously difficult to feed and to eliminate feeding problems a small wire reel and a set of drive rolls are mounted directly on the welding torch. Welding parameters are in the ranges 50–140 A and 17–22 V, resulting in a short-circuiting mode of metal transfer. Travel speeds are generally around 320 mm/min, giving low heat input and enabling thin sheets, around 1 mm in thickness, to be welded without burn-through, excessive penetration or excessive cap height. The fine wire process, although successful, has now largely been replaced by pulsed MIG welding.

#### 7.2.1.3 *Twin wire MIG*

A relatively recent development has been the twin-wire process. The current that can be used is limited in the single wire process by the formation of a strong plasma jet at high welding currents. This jet may cause an irregular bead shape, porosity or excess penetration. The twin wire process overcomes these difficulties with two independent arcs operating in the same weld pool, enabling major improvements in productivity to be achieved. The basis of this is the use of two inverter-based pulsed MIG power sources coupled in series, each complete with its own microprocessor control unit and wire feeder (Fig. 7.9). The two units are linked by a controller that synchronises the pulses from each unit such that when one unit is welding on the peak of a current pulse the other unit is on background current. By this means a stable welding condition is created with the two arcs operating independently of each other. The wires are fed to a single torch carrying two contact tips insulated from each other. The wires may be positioned in tandem, side by side or at any angle in between enabling the bead width and joint filling to be precisely controlled.

The limitation of twin wire MIG is that the process can only be used in a mechanised or robotic application. With suitable manipulators, however, it is capable of very high welding speeds, a 3 mm leg length fillet weld, for



7.9 Microprocessor-controlled inventor-based twin wire pulsed MIG power sources. Courtesy of TPS-Fronius Ltd.

instance, being capable of being made at travel speeds of over 2 metres per minute. The welding torch is large, making access a problem, and the capital cost of the equipment is high.

## 7.2.2 Wire feeders and welding torches

### 7.2.2.1 *Welding torches*

The MIG process requires the filler wire to be delivered to the welding torch (Fig. 7.10) at a fixed speed and for the welding current to be transferred to the wire via a *contact tip* within the torch. The torch must also be equipped with a means of providing the shield gas and of enabling the welder to commence and end the welding sequence. This is generally achieved by means of a trigger on the handle of the torch. Operating the trigger initiates the shielding gas flow and the welding current when the wire tip is scratched on the workpiece surface. This, in its turn, starts the wire feed. Releasing the trigger stops the wire feed and shuts off the current and shielding gas. The heat generated in the torch during welding may also require the torch to be water-cooled. All of these services must be delivered to the torch via an umbilical cable containing a wire feed conduit,



7.10 Exploded view of a typical MIG torch: A ergonomically shaped handle; B contact tip, C gas shroud, D gas diffuser, E power cable connector, F umbilical containing gas hose, power cable and control cable, G power switch, H replaceable liner, I adjustable nozzle. Courtesy of Bernard Welding Equipment Company.

welding current cable, shield gas hose, cooling water delivery and return hoses and the electrical control cables. At the same time the torch must not be made so heavy and cumbersome that the welder cannot easily manipulate the torch with a minimum of effort. A well-designed torch therefore needs to be lightweight, robust and easily maintained and the umbilical cable needs to be light and flexible. It is most important if consistent quality is to be achieved that the welder is provided with the best torch available.

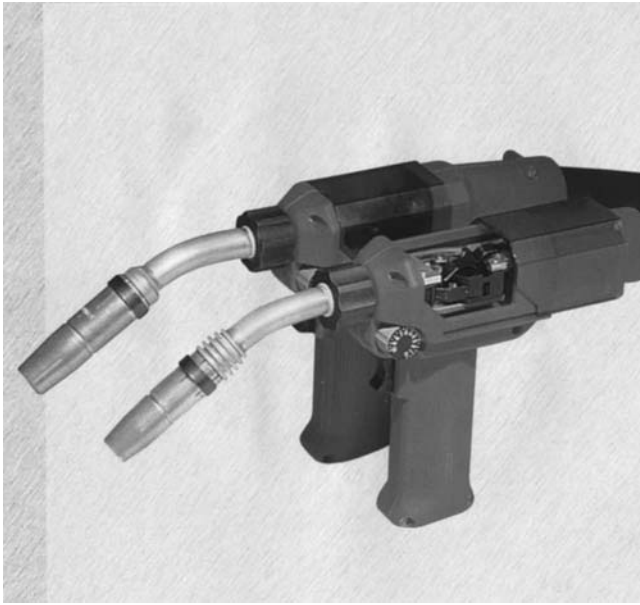

7.11 MIG torches equipped with 'pull' wire drive rolls. Courtesy of TPS-Fronius Ltd.

#### 7.2.2.2 Wire feed systems

There are three basic forms of wire feeders: the 'push' system, the 'pull' system and the 'push-pull' system. As the name suggests, in the push system, the wire is pushed by the wire feed drive rolls along the conduit to the welding torch. The flexibility of aluminium wire means that the wire can buckle and jam inside the conduit, resulting in irregular wire feeding at the welding torch and, in extreme cases, a 'bird's nest' of tangled wire at the wire feed unit. Such wire feeders are generally restricted to a minimum wire diameter of 1.6mm and the wire feed conduit to a length of 3.5m.

The pull system utilises a set of wire rolls in the torch handle which pull the wire from the wire reel (Fig. 7.11). This arrangement increases the weight of the torch and does not increase the distance over which the wire can be fed, this still being limited to around 3.5m, although the consistency of the wire feed is improved and wire diameters down to 0.8mm can be used.

The push-pull system is a combination of the above two systems with a set of drive rolls at both the wire reel feeder and in the torches illustrated in Fig. 7.11. This enables small diameter wires to be fed up to 15m from the wire reel. The final variation on this theme is the spool on gun torch which utilises a small 100mm diameter wire reel mounted on the welding torch and a set of drive rolls in the torch body. These rolls push the wire the short

distance from the reel to the contact tip, enabling wires as small as 0.4 mm in diameter to be used. The length of the umbilical cable is limited only by the voltage drop in the power delivery and return leads and perhaps the need to provide water cooling to the torch.

All of these systems require that the wire is driven at a constant, controlled rate unaffected by continuous operation, variations in supply voltage or fluctuations in temperature. They must also be able to reach the desired wire feed speed as rapidly as possible in order to give good and stable arc starting. The control for feed speed may be mounted on the torch or on the wire feeder.

While manual welding may use any of the systems mentioned, push-pull systems are becoming the standard method of wire feeding in robotic applications because of the need for highly consistent feed speeds and defect-free arc starting.

### 7.2.2.3 *Wire drive rolls*

Aluminium wire is very much softer than steel and this can result in feeding difficulties, the wire being easy to deform by excessive roll pressure, causing the wire to jam in the feed conduit or in the contact tip. With push wire feeders any impediment to the wire feed, such as metal shavings or wire drawing soap compacted in the contact tip, kinks in the wire feed liner or spatter on the contact tip, may cause the wire to buckle within the wire feed conduit. Wire feed rolls must not be knurled but should be smooth, grooved rolls or, better still, one flat roll and one with a 60° V-groove. Wire feeding systems for aluminium also employ four drive rolls (Fig. 7.12) rather than the two rolls that conventionally are used to feed steel wires. It is important that the roll pressure is adjusted such that the wire is not grooved or flattened by the rolls since this will also lead to wire feeding problems. The wire should be kept as clean as possible. Covers to protect the reel from dust and heated cabinets are available and it is recommended that these are used where the highest quality is required. Also available are wire cleaning devices comprising a cloth or felt pad clamped around the wire and soaked in a cleaning fluid such as alcohol or acetone. This can be used to remove grease, drawing soap and loose particles of swarf or oxide at the point at which the wire enters the conduit.

A relatively recent innovation in wire drive rolls is finding increasing use. This is the orbital welding system in which the wire passes through the hollow centre of the drive motor and is driven by a set of rolls set at an angle to and orbiting around the wire. This method of driving the wire has the advantages of both straightening and vibrating the wire, aiding in feeding the wire through the conduit.

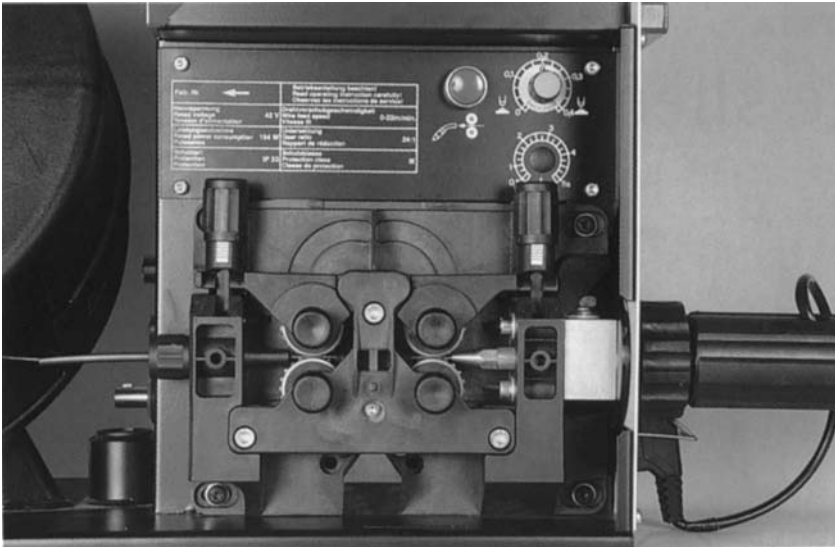

7.12 Four roll MIG wire drive unit. Courtesy of TPS-Fronius Ltd.

#### 7.2.2.4 Contact tip (tube)

The contact tip is a small but vital component in the welding power circuit. The tip is formed from a tube made to be a sliding fit for the wire. It is screwed into the torch head, 'B' in Fig. 7.10, and is the point at which the welding current is picked up by the filler wire. The contact tip is made from copper or brass and wears in use. It is therefore made to be replaceable. The tip for aluminium welding may vary in length from 25 mm to 100 mm. The longer contact tips provide the best current transfer conditions and therefore the most stable welding conditions. Tips have been designed that carry either a spring-loaded shoe to maintain a constant pressure on the wire or with the hole offset in order to force the wire against one wall, thereby improving and maintaining contact.

A worn contact tip may cause the wire to jam, resulting in a tangle at the wire drive rolls. A perhaps more serious weld quality problem may also arise from arc instability caused by the point at which the wire picks up the current moving up and down the contact tip. This effectively changes the wire stick-out length which in its turn affects the voltage, leading to arc instability and lack of penetration defects. Poor contact between the tip and the wire may cause arcing within the tip, giving rise to arc instability and perhaps wire feed problems. Damage to the tip from spatter, accidental touch-down or mechanical damage may cause similar problems.

The tip should be recessed in the gas shroud by at least 5 mm when welding in spray transfer. If the tip is too close to the end of the gas shroud there is an increased risk of spatter damaging the tip. If the tip protrudes from the shroud then there is a risk of the tip touching and melting into the weld pool. This will cause weld pool cracking, may give rise to 'bird's nesting' and will require the tip to be replaced.

## 7.3 Welding consumables

### 7.3.1 Shielding gases

The shielding gases, as with TIG welding, are the inert gases argon and helium or combinations of these two. Other, active, gases such as oxygen or nitrogen even in small amounts will give porosity and smutting problems. The most commonly used gas is argon which is used for both manual and some automatic welding. It is substantially cheaper than helium and produces a smooth, quiet and stable arc, giving a wide, smooth weld bead with a finger-like penetration to give a mushroom-shaped weld cross-section. Argon, however, gives the lowest heat input and therefore the slowest welding speeds. There is therefore a risk of lack of fusion defects and porosity on thick sections. Argon may also give a black sooty deposit on the surface of the weld. This can be easily removed by wire brushing. Sections of 3 mm thick butt welds using conventional and pulsed current are illustrated in Fig. 7.13. Thicker section butt and fillet welds are illustrated in Fig. 7.14. In these thicker section welds the characteristic finger penetration of an argon gas shield can be seen.

Helium increases the arc voltage by as much as 20% compared with argon, resulting in a far hotter arc, increased penetration and wider weld

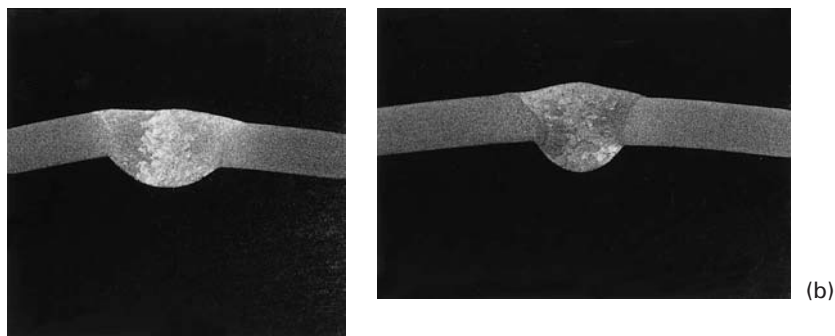

7.13 (a) MIG, argon shielded 0.8mm wire, 3mm thick unbacked plate butt, flat position. (b) Pulsed MIG, argon shielded, 0.8mm diameter wire, 3mm thick unbacked plate butt, flat position.



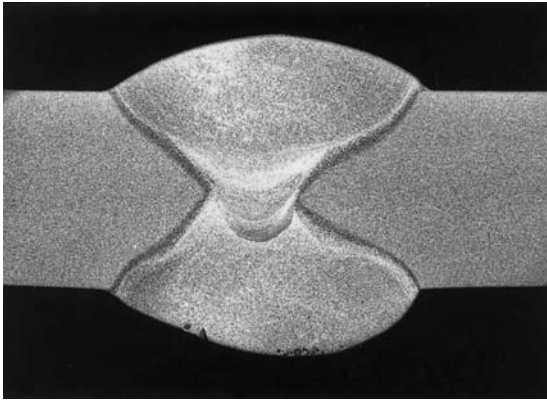

(a)

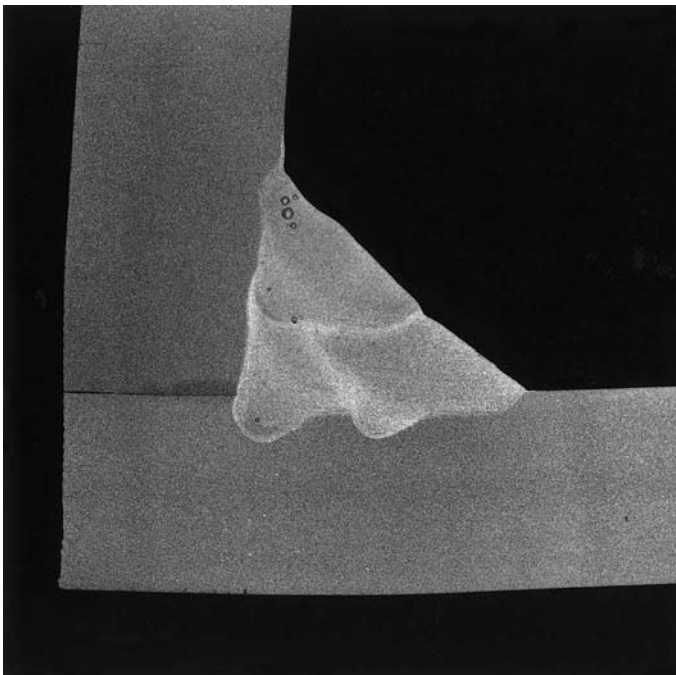

(b)

7.14 (a) MIG, argon shielded, two pass, double sided, 12mm thick, flat position. (b) MIG, argon shielded, 15mm leg length fillet, 12mm thick plate, horizontal-vertical.

bead. The wider bead requires less critical positioning of the arc and assists in avoiding missed edge and lack of penetration-type defects. The hotter, slower cooling weld pool also allows hydrogen to diffuse from the molten weld metal, making this a method that may be used to reduce the amount of porosity. The increased heat also enables faster welding speeds to be

achieved, as much as three times that of a similar joint made using argon as a shielding gas.

Helium, however, is expensive and gives a less stable arc than argon. Pure helium therefore finds its greatest use in mechanised or automatic welding applications. Helium shielded manual welds are illustrated in Fig. 7.15.

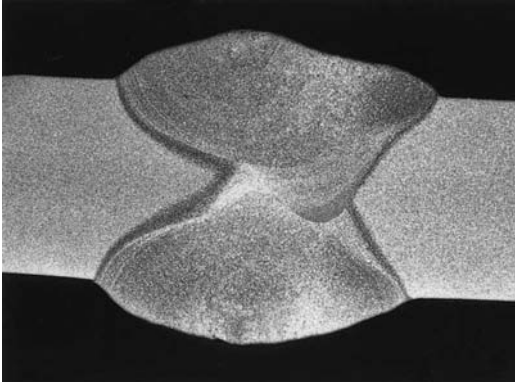

(a)

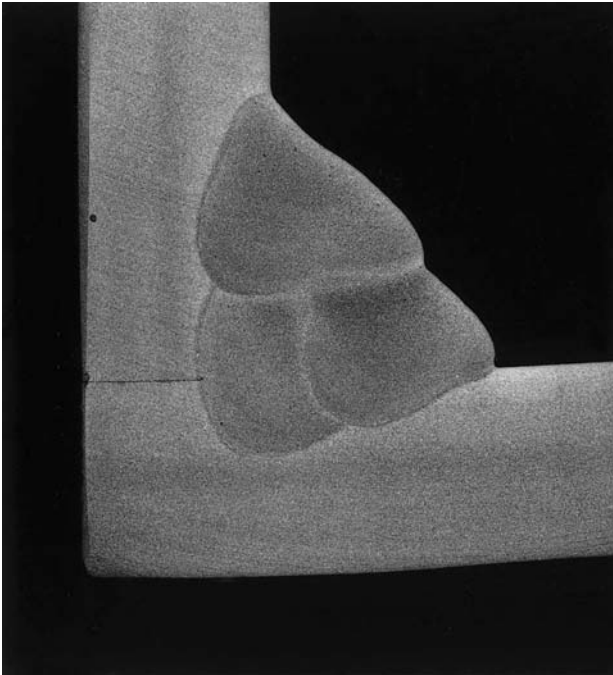

(b)

7.15 (a) MIG, helium shielded, two pass, double sided, 12 mm thick, flat position. (b) MIG, helium shielded, 15 mm leg length fillet, 12 mm thick plate, horizontal-vertical.

For manual welding and some mechanised applications mixtures of argon and helium give good results with characteristics intermediate between the two gases. These mixtures are useful on thicker materials because they increase the heat input and provide a wider tolerance box of acceptable welding parameters than pure argon. They will also improve productivity by enabling faster travel speeds to be used. The most popular combinations are 50% and 75% of helium in argon. Typical welds using 50% helium/50% argon are illustrated in Fig. 7.16. These show weld bead shapes intermediate between the pure argon and pure helium welds in Figs. 7.14 and 7.15.

The last point to be made concerning gases is purity, already covered in Chapter 3, but worth re-emphasising because of the major effect that this has on weld quality. Shielding gases must have a minimum purity of 99.998% and low moisture levels, ideally with a dew point less than  $-50^{\circ}\text{C}$  (less than 39 ppm  $\text{H}_2\text{O}$ ) – do not forget that this is at the *torch*, not at the outlet of the cylinder regulator!

### 7.3.2 Welding filler wire

The wire acts as both the filler metal and the anode in the welding arc. In order to do this the wire picks up the welding current by a rubbing contact between the wire and the bore of the contact tip. Filler wire diameters vary from 0.8mm to 3.2mm which results in a high surface area to volume ratio. This relatively large surface area requires the wire to be kept scrupulously clean since surface contamination will give rise to porosity. Wires should be stored in clean, dry conditions in their unopened packaging where possible. Wires that have been in store for a substantial period of time, e.g. 6 months or more, even when stored in their original packaging can deteriorate and give rise to porosity. If left on the welding machine overnight or over weekends they should be protected from contamination by covering the reel with a plastic bag. In critical applications it may be necessary to remove the reel from the machine and store it in a steel can between periods of use.

Condensation can form on the wire if it is brought into a warm fabrication shop from a cold store, and in conditions of high humidity moisture may once again form on the wire. Some power sources incorporate heaters in the wire feeder to prevent this from happening. If condensation is troublesome and this facility is not available, a 40 watt light bulb installed in the wire feeder cabinet provides sufficient heat to maintain the wire in a dry state.

It is possible to obtain wire cleaning devices that clip on the wire at the point where it enters the wire feed cable. These devices consist of a felt pad carrying a cleaning fluid which removes contaminants as the wire passes

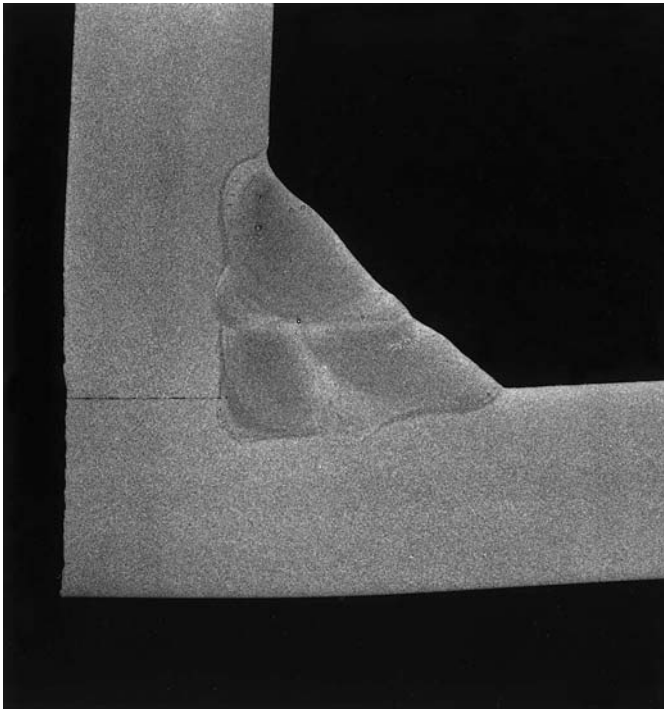
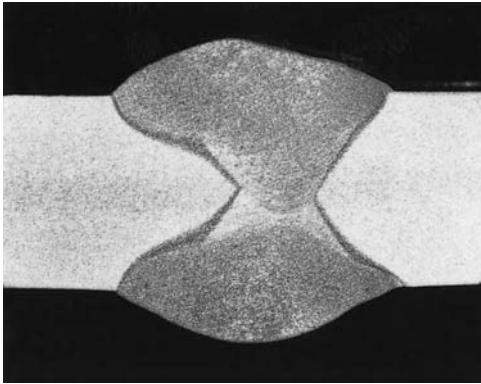

7.16 (a) MIG, helium-argon shielded, two pass, double sided, 12mm plate. (b) MIG, helium-argon shielded, 15mm leg length fillet, 12mm thick plate, horizontal-vertical.

into the cable. They can be very effective at removing traces of grease and oils, dust, etc. on the surface of the wire. Better still is shaving the wire. This not only removes surface contaminants and oxides but hardens the wire, making it easier to feed and less likely to tangle.

## 7.4 Welding procedures and techniques

A set of outline welding procedures are given in Tables 7.2 and 7.3 for butt welding using either argon or helium as the shielding gas, and guidance on parameters for fillet welding is illustrated in Fig. 7.17. The parameters quoted form a starting point from which to develop a procedure specifically designed for the application. They are not to be regarded as hard and fast rules. Also included as Table 7.4 are suggested weld preparations for MIG welding of a range of plate thicknesses.

### 7.4.1 Arc starting

Because the wire is fed into the arc immediately that the arc is started there can be no preheating of the joint as possible with TIG. This results in shallow penetration and a humped weld bead on starting. Lack of fusion defects are often encountered – a ‘cold start’ – and weld bead shape may not be acceptable. To avoid these defects the welder should strike the arc some 25mm ahead of the desired start point and then move back to the weld start before beginning to weld forward at a normal speed.

Arc starting may be achieved using a scratch start where the wire is allowed to protrude from the contact tip by 10mm and brought to within 20mm of the surface. The trigger is operated and at the same time the welding torch is moved to scrape the wire tip over the work surface. As soon as the arc is established the power source senses the change in voltage and starts the wire feed, the weld pool forms and welding can commence. A ‘running’ start is one where the wire begins to feed as soon as the trigger is operated and is short-circuited when it touches the workpiece, establishing the arc. The current surge on short-circuiting may cause arcing within the contact tip and spatter to adhere to the shroud and contact tip. These can lead to wire feeding problems.

As mentioned earlier, the new inverter power sources have a facility for a highly controlled arc start sequence. When the trigger is operated the wire is fed at a slow and controlled rate until the wire tip touches the workpiece. It is then retracted slightly and a pilot arc is ignited. Once this is stable the current is increased at a controlled rate, the wire speed increased to the desired feed rate and welding commences (Fig. 7.8). This gives a spatter-free start and a low risk of lack of fusion defects, a major improvement over the capabilities of older equipment.

Table 7.2 Suggested welding parameters – argon shielding

Thickness (mm)	Root gap/ face (mm)	Included angle (degrees)	Backing	Current (A)	Voltage (V)	No. of passes	Filler diam. (mm)	Travel speed (mm/min)
1.6	nil	Square	Temporary	100	19	1	0.6	1000
	2.5	Square	Permanent	100	19	1	0.6	1000
2.4	nil	Square	Temporary	140	21	1	0.6	1000
	3.2	Square	Permanent	130	23	1	0.6	780
3.2	2.5	Square	Temporary	160	24	1	1.2	780
	5	Square	Permanent	135	23	1	1.2	720
4	1.5	Square	None	170	26	1 face 1 reverse	1.2	750
	1.5/2.5	60 single-V	Temporary	160	27	1	1.2	750
	4.5/1.5	60 single-V	Permanent	185	27	2	1.6	750
6.3	2.5	Square	None	200	28	1 face 1 reverse	1.6	750
	2.5/2.5	60 single-V	Temporary	185	27	2	1.6	750
	6/1.5	60 single-V	Permanent	225	29	3	1.6	750
8	2.5/1.5	60 single-V	Temporary	245	29	2	1.6	750
	4.5/nil	60 single-V	Permanent	255	29	3	1.6	750
10	2.5/4.5	90 single-V	None	290	29	1 face 1 reverse	1.6	750
	2.5/2.5	60 single-V	Temporary	275	29	2 face 1 reverse	1.6	900
	4.5/nil	60 single-V	Permanent	275	26	3	1.6	800/550

12.5	0.8/1.5	90 double- V	None	260/225	24/26	3 face 3 reverse	1.6	1050 root/ 800
	2.5/1.5	60 single-V	Temporary	260	24	3 face 1 reverse	1.6	850 root/ 550
	4.5/nil	60 single-V	Permanent	270	24	3	1.6	550 root/ 500
16	1.5/1.5	90 double- V	None	275	23/26	4 face 4 reverse	1.6	850 root/ 650
	4.5/nil	60 single-V	Permanent	280	26	4	1.6	550 root/ 450
20	1.5/1.5	90 double-V	None	255 root/ 230	22/26	4 face 4 reverse	1.6	900 root/ 550
	3/2.5	60 single-V	Temporary	350	29	4 face 1 reverse	2.4	1000
	6/nil	60 single-V	Permanent	380	30	5	2.4	1000
25	1.5/1.5	90 double- V	None	255 root/ 230	22/26	6 face 6 reverse	1.6	600
	4/2.5	60 single-V	Temporary	350	29		2.4	1000
	6/nil	60 single-V	Permanent	350	29		2.4	1000

- 
1. Where two welding parameters are specified in one entry the first refers to the requirements for the first pass.
  2. Where a reverse side weld is specified it is necessary to grind the reverse of the root pass to ensure a sound joint.
  3. When making a double sided joint it is recommended that the weld passes are balanced to reduce distortion.

Table 7.3 Suggested welding parameters – helium shielding, flat position, large diameter wires

Thickness (mm)	Root gap/face (mm)	Included angle (degrees)	Current (A)	Voltage (V)	No. of passes	Filler diam. (mm)	Travel speed (mm/min)
50	0/5	70/2 sided	550	32	2 each side	4.8	250
75	0/10 6mm root R	30	650	30	3 each side	5.6	250

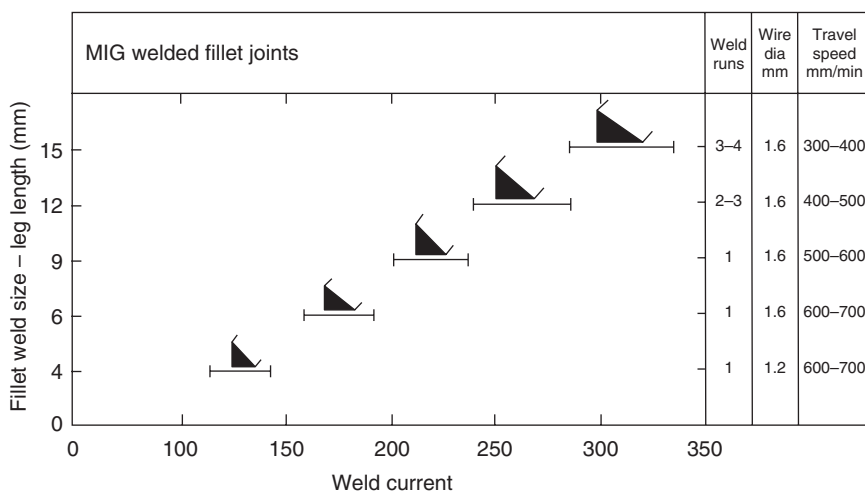

7.17 Suggested parameters for fillet welding – argon shielding.

### 7.4.2 Torch positioning

The angle at which the torch is presented to the joint is important in that an incorrect angle can result in air entrainment in the shielding gas and will also affect the degree of penetration. Ideally the torch should be normal to the surface and pointed forwards towards the direction of travel at an angle of between 10° and 15° from the vertical, the *forehand* angle (Fig. 7.18). As this angle increases penetration decreases and the amount of air entrained in the shielding gas gradually increases.

Arc length cannot be set by adjusting the voltage since this is a function of the resistance of the circuit as a whole. The arc length is set by the welder using both sight and sound, a correct arc length being characterised by a



Table 7.4 Suggested weld preparations for MIG welding

Material thickness (mm)	Edge preparation	Remarks
1.6–4.8 mm		A backing bar gives greater control of penetration
6.4–9.5 mm		Weld from both sides, sighting Vs recommended
4.8–12.7 mm		Suitable also for positional welding, when welded from both sides
6.4–12.7 mm		Flat aluminium backing bar optional. One or more runs from each side. Back chipping recommended after first run
6.4–19.1 mm		One or more runs from one side, depending on thickness. Suitable also for positional welding
12.7–25.4 mm		Up to 1.6 mm root gap. One or more runs from each side. Back-chipping recommended after first run
12.7–25.4 mm		
12.7–25.4 mm		

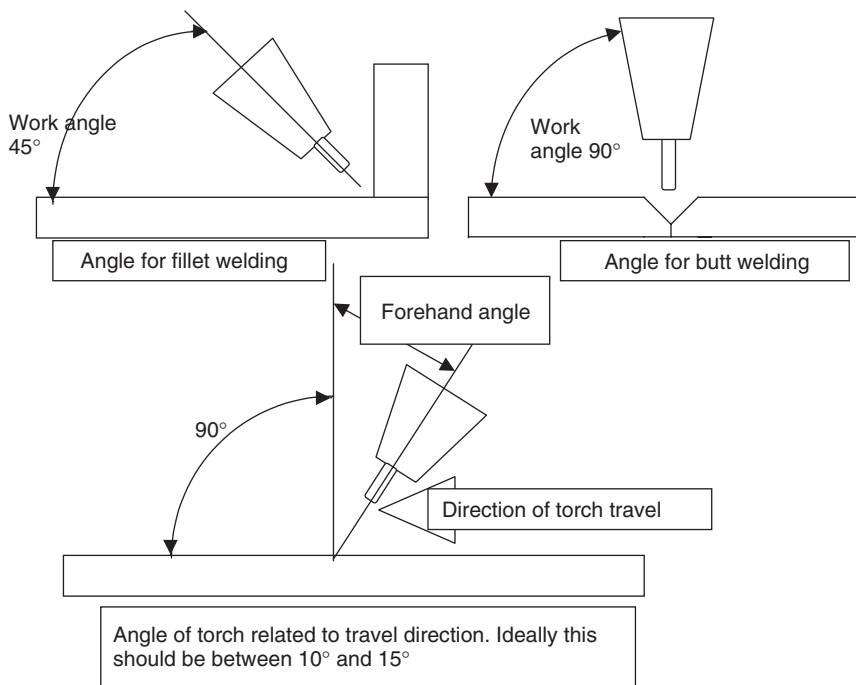

7.18 Torch position for MIG welding.

Table 7.5 Effect of arc length

Weld Bead	Short Arc	Long Arc
Excess metal	High	Flat
Penetration	Deep	Shallow
Width	Narrow	Wide
Porosity	Higher	Lower
Spatter	Higher	Lower

soft crackling sound similar to the sound of frying bacon. Too short an arc sounds harsh and gives excessive spatter while a long arc has a humming sound. The effect of changing the arc length is summarised in Table 7.5.

### 7.4.3 Ending the weld

If, when the weld is ended, the wire feed is abruptly stopped the weld pool will freeze and a shrinkage crater will form. If the weld pool is small this crater may be simply a shallow depression in the weld surface. In large weld

pools the crater may extend down into the weld to form an elongated pore – *pipng porosity*. As the weld continues to cool and contract then the associated shrinkage stresses may cause hot short or crater cracks to form. Any form of cracking is unacceptable and is to be avoided. Methods of eliminating this defect include the following:

- The use of run-off tabs on which the weld can be terminated, the tab being subsequently removed.
- Increasing the travel speed just before releasing the trigger. This causes the weld pool to tail out over a distance. It requires a high measure of skill on the part of the welder to produce acceptable results.
- Making a small number of brief stops and starts into the crater as the weld cools. This adds filler metal to the crater.
- As the trigger on the torch is released the wire feed speed and the welding current are ramped down over a period of time. The crater is fed with progressively smaller amounts of molten filler metal as it forms, resulting in the filling and elimination of the crater. This crater filling facility is standard on modern equipment and is the preferred method for avoiding piping porosity and crater cracks.

## 7.5 Mechanised and robotic welding

As MIG welding is a continuously fed wire process it is very easily mechanised. The torch, having been taken out of the welder's hand, can be used at welding currents limited only by the torch or power source and at higher travel speeds than can be achieved with manual welding. A typical robot MIG welding cell where the robot is interfaced with a manipulator for increased flexibility and a pulsed MIG power source is illustrated in Fig. 7.19. Greater consistency in operation means that more consistent weld quality can be achieved with fewer defects. The advantages may be summarised as follows:

- More consistent quality.
- More consistent and aesthetically acceptable bead shape.
- More consistent torch height and angle mean that gas coverage can be better and the number of defects reduced.
- Fewer stops and starts, hence fewer defects.
- Higher welding speeds means less heat input, narrower heat affected zones and less distortion.
- Higher welding current means deeper penetration and less need for large weld preparations with fewer weld passes and therefore fewer defects.
- Higher weld currents mean a hotter weld and reduced porosity.

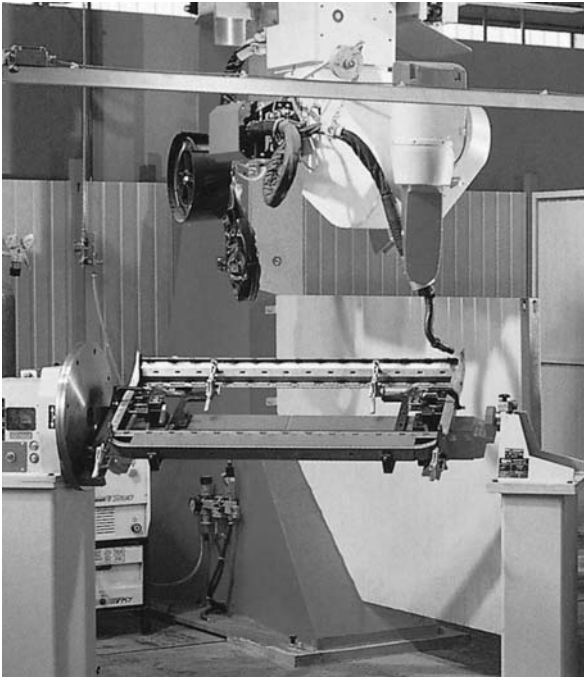

7.19 Pulsed MIG power source interfaced with a robot and manipulator. Courtesy TPS-Fronius Ltd.

- The above advantages mean that less welding time is required and rework rates will be reduced, giving major improvements in productivity and reductions in cost.
- There is no need for the skilled welder required for manual welding, a major advantage in view of the current shortage of highly skilled welders. The loading and unloading of the welding cell can be performed by unskilled workers, although knowledgeable and experienced engineers will be needed to programme and maintain the equipment.

There are some disadvantages to mechanised and robotic welding. Weld preparations need to be more accurate and consistent; more planning is needed to realise fully the benefits; capital expenditure will be required to purchase manipulators and handling equipment; maintenance costs may well be higher than with manual equipment and the full benefits of high deposition rates may only be achieved in the flat or horizontal-vertical position. Despite these problems there is an increased usage of mechanised and automated MIG equipment because of the financial benefits that may be achieved.

Table 7.6 High current mechanised MIG parameters

Thickness (mm)	Joint type	Backing	Current (A)	Voltage (V)	Travel speed (mm/min)
12	Square edge	Temporary	400	26.5	380
12	Square edge	Permanent	450	29	350
19	Square edge	Temporary	540	33	275
19	Square edge	Two sided	465	29.5	380
25	Square edge	Two sided	540	33	275
32	Square edge (6mm sight V)	Two sided	530	33	275

To illustrate the cost benefits of mechanisation take as an example a 12mm thick butt weld. Made using manual MIG this would require four passes to fill at a travel speed of around 175mm/min, a total weld time of over 20 minutes per metre. A machine weld using argon as the shield gas could be made in a single pass at around 480mm/min travel speed, a total weld time of just over 2 minutes. Using helium as the shielding gas would reduce this time even further. A set of typical parameters is given in Table 7.6.

Because of the higher duty cycle achievable with mechanised or automated welding the power source, wire feeder and torch must be more robust and rated higher than those required for manual welding. Welding currents of 600 A or more may be used and this must also be borne in mind when purchasing a power source. The torch manipulator, whether this is a robot, a dedicated machine or simply a tractor carriage, must have sufficient power to give steady and accurate motion at a uniform speed with repeatable, precise positioning of the filler wire. Although at low welding currents conventional manual equipment may be adapted for mechanisation by attaching the torch to a manipulator, it is advisable to use water-cooled guns and shielding gas shrouds designed to provide improved gas coverage.

## 7.6 Mechanised electro-gas welding

A technique described as electro-gas welding was developed by the Alcan Company in the late 1960s but seemed to drop out of favour in the late 1990s, which is surprising when the advantages of the process are considered. The weld may only be carried out in the vertical-up (PF) position but is capable of welding both square edge butt joints and fillet welds with throats of up to 20mm in a single pass.

To operate successfully the process uses a long arc directed to the back of the penetration cavity. This provides a deeply penetrating arc that

operates in the space above the weld pool. The pool fills the cavity below the arc, solidifying as the torch is traversed vertically up the joint line. The molten pool is retained in position and moulded to shape by a graphite shoe attached to and following immediately behind the welding torch.

The process utilises a drooping characteristic power source capable of providing 600 A at 100% duty cycle coupled to a water-cooled machine torch. The torch is mounted on a vertical travelling carriage at an angle of 15° from the horizontal. The gas shroud should be at least 25 mm in diameter and the tip of the contact tube should be flush with the shroud.

For butt welding the graphite shoe is made from a flat plate shaped with a groove to mould the cap, flared out towards the top of the shoe where the weld pool is formed. The fillet weld mould is provided with a pair of 'wings' set back to press against the plates to form the fillet. In both cases the shoe is held against the plates by spring pressure. The shoe must be long enough to hold the molten metal in place until it has solidified – in the region of 100 mm may be regarded as sufficient. It has been found that heating the shoe to 350°C before commencing welding assists in preventing fouling of the shoe with parent metal.

During welding the arc must be prevented from arcing onto the weld pool or the graphite shoe. This requires careful control of the wire position and the wire feed speed, as a balance must be achieved between the volume of metal being fed into the pool, the volume of the mould and the traverse speed.

## 7.7 MIG spot welding

MIG spot welding may be used to lap weld sheets together by melting through the top sheet and fusing into the bottom sheet without moving the torch. The equipment used for spot welding is essentially the same as that used for conventional MIG, using the same power source, wire feeder and welding torch. The torch, however, is equipped with a modified gas shroud that enables the shroud to be positioned directly on the surface to be welded (Fig. 7.20). The shroud is designed to hold the torch at the correct arc length and is castellated such that the shield gas may escape. The power source is provided with a timer so that when the torch trigger is pulled a pre-weld purge gas flow is established, the arc burns for a pre-set time and there is a timed and controlled weld termination. The pressure applied by positioning the torch assists in bringing the two plate surfaces together. Because of this degree of control the process may be used by semi-skilled personnel with an appropriate amount of training.

The process may be operated in two modes: (a) by spot welding with the weld pool penetrating through the top plate and fusing into the lower one or (b) by plug welding where a hole is drilled in the upper plate to enable

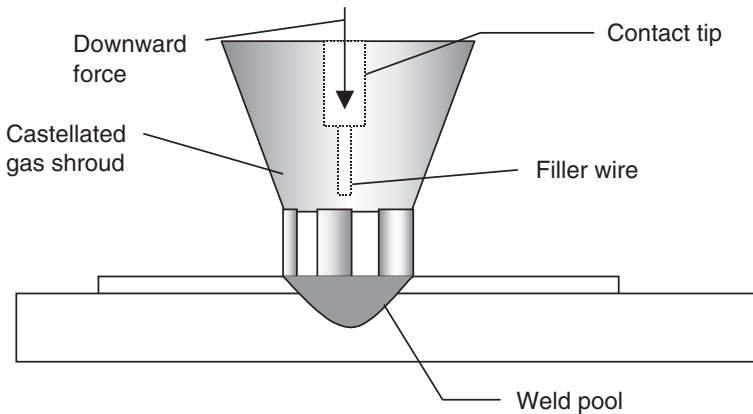

7.20 Schematic of the MIG spot welding process.

Table 7.7 Spot and plug welding parameters

Top plate (mm)	Bottom plate (mm)	Preparation	Current (A)	Voltage (V)	Weld time (s)
1.0	1.0	Cu backed	320	23	0.8
1.0	2.5	Cu backed	325	23	1.0
1.5	1.5	Cu backed	335	24	1.0
1.5	2.5	Cu backed	350	24	1.2
1.5	3.2	None	240	23	2.0
2.5	2.5	9mm hole	180	26	2.5
2.5	6.3	None	350	24	2.0
3.2	3.2	10mm hole	260	25	2.3
6.4	12.5	11mm hole	400	24	2.0
6.4	12.5	13mm hole	370	25	2.5

the arc to operate directly on the lower plate so that full fusion can be achieved. Plug welding is generally required when the top sheet thickness exceeds 3mm. The size of the drilled hole is important in that this determines the size of the weld nugget and the diameter should be typically between 1.5 and 2 times the top sheet thickness. Typical welding parameters are given in Table 7.7.

Of the shield gases argon is the preferred choice as it produces a deep, narrow penetration. Argon also provides better arc cleaning than helium, important in maintaining low levels of oxide entrapment. Arc stability is also superior. Surface preparation is important, cleanliness being crucial to defect-free welds. As with butt welds, degreasing and stainless steel wire brushing, supplemented by scraping if a hole is drilled, are most important.

Welding can be carried out with equal ease with the plate in the horizontal, vertical or overhead position although in other than the flat position the welding time needs to be reduced from that listed in Table 7.7. This may result, however, in an increased level of porosity. Other defects include cracking, lack of fusion and burn-through. To prevent and control burn-through a temporary backing bar may be used. Fit up is important and for the highest strength the gap between the plates should be as small as possible.



## 8.1 Introduction

While MIG and TIG welding may be regarded as the most frequently used processes for the joining of aluminium and its alloys there are a large number of other processes that are equally useful and are regularly employed although perhaps in rather more specialised applications than the conventional fusion welding processes. Some of these processes are discussed here.

## 8.2 Plasma-arc welding

As described in Section 4.3 a modification to the TIG welding torch enables a strong plasma jet to be produced that has some very desirable features for both welding and cutting. Despite these advantages the process found little application for the welding of aluminium when DC electrode negative or electrode positive were used because of extensive lack of fusion defects. Alternating current gave no better results as high currents were required, resulting in rapid electrode deterioration. The pulsing of the current also caused weld pool instability, poor bead shape and lack of fusion defects. These limitations were overcome with the development of square wave power sources, already mentioned in Chapter 6, since which time plasma-TIG has become accepted as a viable production process.

### 8.2.1 Plasma-TIG welding

#### 8.2.1.1 *Main characteristics*

As mentioned above, the basic principles of the plasma-TIG process (EN process number 15) have been covered in Section 4.3 which describes the use of the heat from the plasma-arc for cutting purposes. For welding the transferred arc plasma-jet is used as the heat source, the major difference

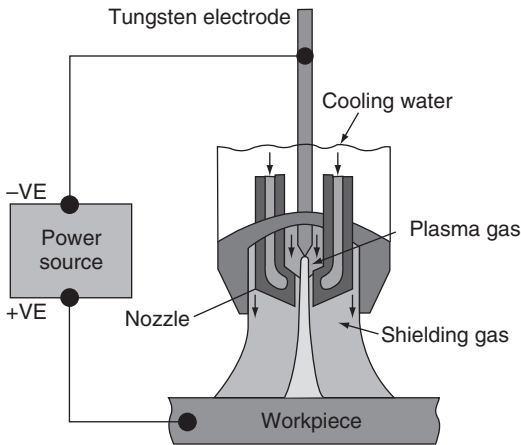

8.1 Principles of the plasma-TIG transferred arc torch. Courtesy of TWI Ltd.

from cutting being that no cutting gas is introduced to blow away the molten metal (Fig. 8.1).

There are a number of advantages that plasma-TIG has compared with conventional TIG mainly because of the cylindrical and constricted plasma column. This provides less sensitivity to process variables than with the TIG process. The constricted plasma column means that the heat is confined to a smaller area than with TIG, enabling a very stable controllable arc to be produced at currents as low as 0.1 A. It is possible to weld without keyholing at thicknesses less than 2.5 mm but there is little advantage to be gained in terms of productivity over TIG. The keyholing technique may be used in manual welding but it is more common to find it in mechanised or automated applications.

The plasma is strongly directional and can be pointed in any given direction even at very low currents. The cylindrical plasma column means that heat input is constant irrespective of torch to workpiece distance, unlike TIG with its conical arc. The tungsten electrode is recessed inside the torch nozzle, making tungsten contamination an impossibility. There is also an increase in weld quality with a reduced risk of porosity and distortion. Higher welding currents enable material as thick as 15 mm to be welded positionally in a single pass with a square edge weld preparation using the keyhole technique although in the flat position the maximum thickness is limited to around 8 mm without filler metal.

The process may be used in a melt-in mode using techniques similar to those that would be used for TIG. The weld may be made autogenously in those alloys that are crack-resistant; filler wire may be added to those that are crack-sensitive. This wire can be added manually but torches are avail-

able equipped with automatic wire feed. This latter feature, however, makes the process sensitive to stand-off distance. A change in the stand-off will affect the position in which the wire enters the weld pool and this may give variable weld quality.

The problem with conventional plasma-TIG is that the process normally operates on DC negative polarity so that no cathodic cleaning takes place, an obvious disadvantage when welding aluminium. Welding without the facility to remove the oxide layer causes porosity. To overcome this a development of the DC positive plasma-TIG process, the variable polarity plasma process was developed. This utilises a square wave form with a suitable balance of the DC negative and positive components to provide both melting and adequate oxide removal.

### 8.2.1.2 Variable polarity plasma-arc process principles

For the plasma to form, a pilot arc is first established within the torch annulus by means of a high-frequency discharge. As the plasma gas passes through this HF discharge it is ionised, allowing the welding current to flow and the plasma flame to be established. The plasma gas flow is very small, typically 1–5 litres/min. This is insufficient to provide adequate shielding and therefore needs to be supplemented with a secondary shield gas. The gases are generally high-purity argon similar in quality to that used for TIG welding, but helium or argon–helium mixtures may also be used.

Arc stability and oxide removal are better than with TIG or MIG provided that the appropriate wave form is used. It is necessary to tailor each wave form and the balance between DC electrode positive and DC electrode negative to the individual alloy composition. Typical wave form characteristics for the keyhole welding of a number of alloys are given in Table 8.1. It is worth remembering that if the keyhole technique is used autogenously the alloys must be capable of providing crack-free weld metal.

Table 8.1 Typical parameters for keyhole welding of 6.5 mm thick Al alloys

Aluminium grade	Electrode negative		Electrode positive	
	Current (A)	Time (ms)	Current (A)	Time (ms)
2219	140	20	185	3
3001	155	20	220	3
5086	145	20	180	3
5456	130	20	185	3
6061	150	20	210	3

Over 8mm thick it is necessary to weld with a prepared edge and filler wire although in the vertical-up (PF) position material as much as 16mm thick can be welded. The diameter of the filler wire is the same as would be used for TIG welding, generally 1.6 or 2.4 mm diameter.

### 8.2.2 Plasma-MIG welding

Plasma-MIG welding utilises a MIG wire, generally 1.6 mm in diameter, fed through a plasma-arc torch. This allows a higher combined welding current to be used than for the MIG wire alone with a high current density and a higher deposition rate than MIG being achieved. This enables welding speeds to be increased giving lower heat input and narrower heat affected zones with better mechanical properties.

The process is generally used in a mechanised or automated application although it is possible to use it in a semi-automatic manual mode. The thickness that has been welded ranges from 6 mm to 60 mm.

## 8.3 Laser welding

Laser welding is being used increasingly in both the automotive and aerospace industries for the welding of a range of materials (Fig. 8.2). The laser welding of aluminium and its alloys has, however, presented problems to the welding engineer. Poor coupling of the beam with the parent metal, high thermal conductivity, high reflectivity and low boiling point alloying elements have, until relatively recently, prevented the achievement of consistent weld quality.

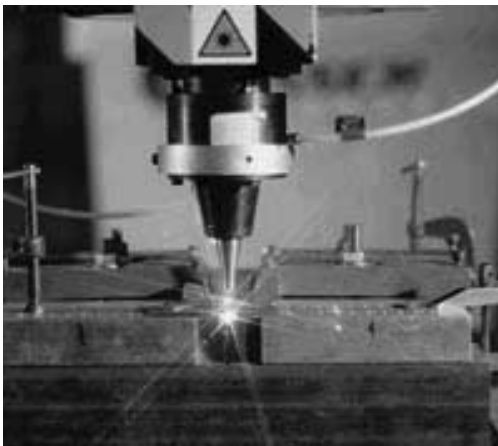

8.2 Laser weld of thin plate. Courtesy of TWI Ltd.

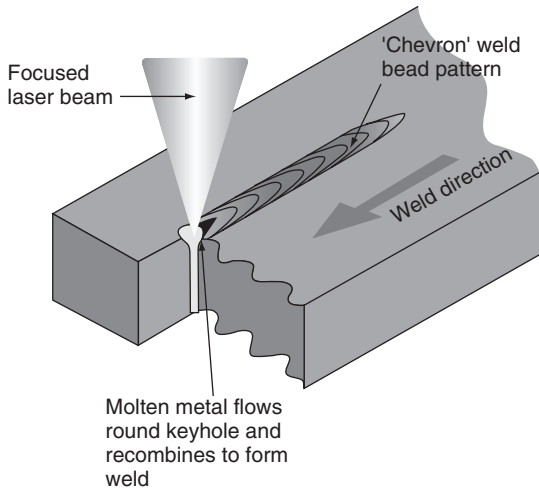

8.3 Principle of laser welding. Courtesy of TWI Ltd.

The wavelength of the laser light affects the *coupling* – the absorption of the beam energy by the metal being cut or welded. As the wavelength increases the coupling becomes poorer and this is a particular problem with aluminium and its alloys. The wavelength of light from a CO<sub>2</sub> laser is 10.6 μm, that of a Nd-YAG laser 1.06 μm – the solid state laser is therefore better suited to the welding of aluminium. Development work, carried out mostly for the automotive industry on sheet metal, has also been of assistance in minimising these problems by improved focusing of the beam with both types of laser. One of the earliest applications for this development is the Audi A2 which has some 30 metres of laser welds in its bodywork. The main reason for the improvement in laser weldability has been the ability to achieve high-power densities, typically above 40 kW/mm<sup>2</sup>, with both the Nd-YAG solid state and CO<sub>2</sub> gas lasers. As a process, laser welding offers the advantages of a concentrated, high-energy density heat source. This power density enables the weld to be made in the keyhole mode (Fig. 8.3), improving the absorption of the laser beam due to reflections within the cavity. The deeply penetrating keyhole weld produces very narrow heat affected zones, minimising both distortion and the loss of strength in the HAZ of the work or precipitation-hardened alloys and reducing the loss of low boiling point alloying elements such as magnesium.

The low boiling point elements, however, assist in establishing a stable keyhole. The high-energy beam also enables very fast welding speeds to be achieved, speeds of 2 metres per minute with a 2 kW Nd-YAG and 5–6 metres per minute with a 5 kW CO<sub>2</sub> laser in 2 mm thick sheet being easily

attainable. The main welding parameter is the laser power which determines both the depth of penetration and the travel speed. Other variables are the position of the focal point, generally at the upper surface, wire diameter and feed speed and weld gap.

Defects in laser welded joints are similar to those encountered in welds made by other fusion welding processes. Porosity is caused by hydrogen from the environment, dissolved in the parent metal, contained in the oxide film or from an unstable keyhole condition. The solution to this problem is careful surface preparation including pickling and scraping, gas shielding and the use of adequate power to ensure the creation of a stable keyhole. Although most of the non-heat-treatable alloys are capable of being welded successfully, hot cracking may be encountered, particularly in those alloys that are sensitive. This can be reduced or eliminated by the addition of a suitable filler wire. The last difficulty is caused by the low viscosity of the molten weld metal. This causes the problem of 'drop-through', where the weld metal falls out of the joint when welds are made in the flat position. This problem can be overcome by welding in the horizontal-vertical (PC) position.

### 8.3.1 CO<sub>2</sub> laser welding

As mentioned above improved focusing has enabled very concentrated beams with energy densities above 40 kJ/mm<sup>2</sup> to be produced. This has been achieved by using parabolic reflectors or transmissive systems with a focal length of around 150 mm. The alloy content affects the energy required to achieve a keyhole with increasing levels of zinc or magnesium requiring less energy. This is attributed to the low vaporisation temperature of these alloying elements assisting in the formation of the keyhole. One corollary of this is that higher welding speeds are possible in those alloys with the higher magnesium contents.

Helium gas shielding of both the root and face of the weld is recommended for the higher magnesium-containing alloys such as 5083 (Al4.5Mg). Over some 3 mm in thickness a jet of helium, supplementing the shielding gas, directed at the weld pool also gives improved weld appearance. Helium-argon mixture and pure argon gas have also been used with acceptable results although with a reduced parameter tolerance box.

Wire additions may be used to increase the resistance to hot cracking in those alloys that cannot be autogenously welded such as the 6XXX and 7XXX series of alloys. Wire additions are also beneficial in coping with gaps, a 1.2 mm wire can be used to fill gaps of up to 1.2 mm. Wire diameters may be between 0.8 and 1.2 mm. Feeding the wire into the leading edge of the

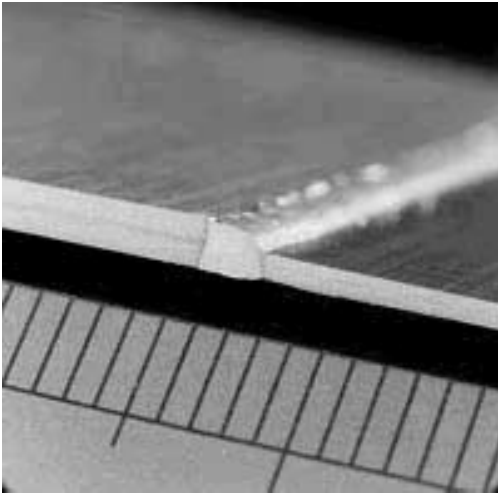

8.4 Laser weld of dissimilar thickness of automotive panelling. Courtesy of TWI Ltd.

weld pool at an angle of around  $45^\circ$  will improve the bead shape on both root and cap.

The majority of welding has been carried out on butt welded sheets (Fig. 8.4). The joint between the sheets results in an increase in beam absorption and improved keyhole stability compared with bead-on-plate welds. Good fit-up is necessary for autogenous welding if undercut is to be avoided. This requires either square machined or high-quality guillotined edges. Where lower-quality edges are produced, wire additions can be used to cope with any gaps. Where extrusions are welded, a small 'V' on the weld face aids in penetration by reflecting laser light within the preparation.

### 8.3.2 Nd-YAG solid state welding

The wavelength of the light from solid state lasers is only a tenth of the wavelength of light from a gas laser. It is believed that this permits better coupling of the beam with the parent metal. The short wavelength also enables the laser light to be transmitted via fibre optics, rather than by the use of the copper mirrors that are used to manipulate the light from the  $\text{CO}_2$  laser (Fig. 8.5). This gives greatly improved flexibility, allowing the use of a robot to move and position the beam. Most of the techniques used for  $\text{CO}_2$  welding apply to the solid state laser and, as with the  $\text{CO}_2$  laser, there is a critical power density required to achieve keyhole penetration. An average laser power less than 1 kW is regarded as being the lower acceptable limit for the avoidance of lack of penetration or porosity.



8.5 Nd-YAG laser interfaced with a robot. Courtesy of TWI Ltd.

Since the early 1990s the power available from the solid state lasers has increased so that a pulsed 3 kW laser is capable of welding speeds of up to 2.3 metres per minute in 1.5 mm thick 5XXX alloys. Gas shielding, similar to that for CO<sub>2</sub>, can be achieved using either argon, helium or nitrogen fed co-axially with the beam or from a simple side port. Gas shielding of the underbead will also give an improvement in the surface finish.

High-power diode lasers (HPDLs) are also being investigated and it is likely that they will become commercially available in the near future. There are several advantages with this type of laser, price and low maintenance being two. With the recent improvements in optics, HDPLs are capable of achieving power densities of  $5 \times 10^4 \text{ W/cm}^2$  and, with wavelengths of around 800 nm, are producing good results when used to weld aluminium.

### 8.3.3 Welding defects

CEN standards are being developed to cover the quality assurance and quality control of laser welds in a range of metals, for example EN ISO 13919-1 and EN 288 part 15. ASME IX already has requirements regarding procedure approval testing of laser welds. A brief summary of laser welding defects is included in Table 8.2.

### 8.3.4 Arc augmented laser welding

There have been a number of relatively new developments where the laser has been combined with the arc from a conventional welding power source.



Table 8.2 Summary of laser welding defects and corrective actions

Unacceptable defect	Corrective action
Cracks	Check material specification Check filler metal composition if used Check welding speed Check weld shape
Lack of penetration	Increase laser power Reduce welding speed Improve beam focus Improve gas shielding
Lack of fusion	Improve beam alignment with respect to the joint
Porosity	Check for and remove surface contamination Check gas for moisture and contamination Improve gas shielding
Undercut	Improve fit-up, eliminate gaps Check welding parameters Consider wire feed
Sheet misalignment	Improve fit-up and accuracy of weld prepared components
Discoloration/oxidation	Improve gas shielding Improve gas quality

The MIG, TIG and plasma-arc processes have been used, enabling higher welding speeds to be achieved, particularly in thin sheet for the automotive industry. Of these options MIG welding is the preferred fusion welding process, although the plasma/laser process is also being actively developed and is producing good results. Figure 8.6 illustrates a commercially available laser/MIG welding head and Fig. 8.7 the principles of operation.

In addition to higher speeds the enhancement of the laser beam enables greater variations in fit-up to be tolerated. Penetration, it is claimed, is increased and the change in shape of the weld pool assists in allowing hydrogen to diffuse out of the joint, reducing the porosity often encountered in laser welds. At present (2002) these augmented laser processes are in the early stages of development but show great promise in widening the field of applications of the process.

## 8.4 Electron beam welding

Electron beam welding is, like laser welding, a power beam process ideally suited to the welding of close square joints in a single pass. Unlike the laser beam, however, the electron beam process utilises a vacuum chamber in

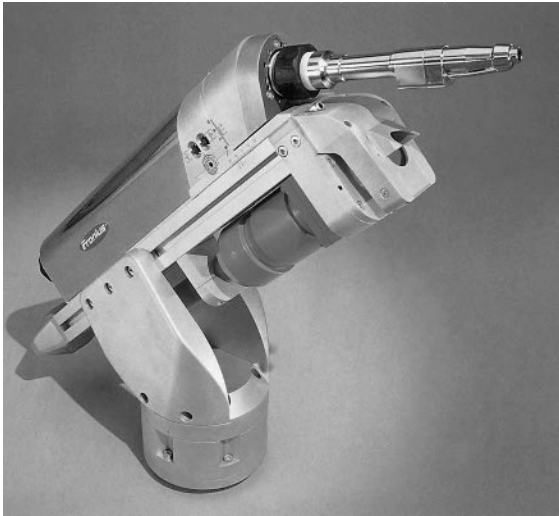

8.6 Combined laser and MIG welding head. Courtesy of TPS-Fronius Ltd.

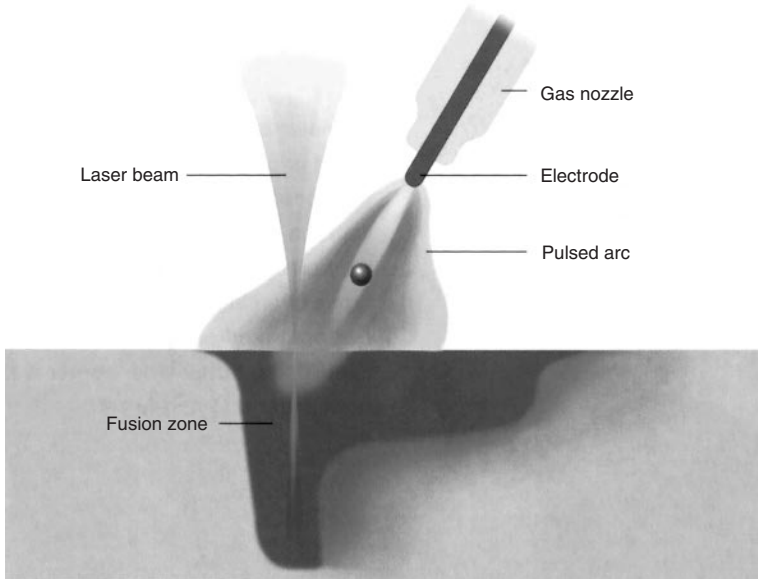

8.7 Principles of operation of the laser/MIG process. Courtesy of TPS-Fronius Ltd.



8.8 A 2 m<sup>3</sup> chamber, 100 kW, electron beam welding machine, showing the open vacuum chamber. It is capable of welding up to 200 mm thick aluminium. Courtesy of TWI Ltd.

which is generated a high-energy density beam of electrons of the order of 0.25–2.5 mm in diameter (Fig. 8.8).

The beam is generated by heating a tungsten filament to a high temperature, causing a stream of electrons that are accelerated and focused magnetically to give a beam that gives up its energy when it impacts the target – the weld line. This enables very deep penetration to be achieved with a keyhole penetration mode at fast travel speeds (Fig. 8.9), providing low overall heat input.

The process may be used for the welding of material as thin as foil and up to 400 mm thick in a single pass. The keyhole penetration mode gives almost uniform shrinkage about the neutral axis of the component, leading to low levels of distortion. This enables finish machined components to be welded and maintained within tolerance. The transverse shrinkage also results in the solidifying weld metal being extruded from the joint to give some excess metal outside the joint (Fig. 8.10).

The major welding parameters are (a) the accelerating voltage, a 150 kV unit being capable of penetrating 400 mm of aluminium; (b) the current applied to the electron gun filament, generally measured in milliamperes; and (c) the travel speed. The item to be welded is generally mounted on an NC manipulator, the gun being held stationary. The unwelded joint components are required to be closely fitting and are usually machined. Filler

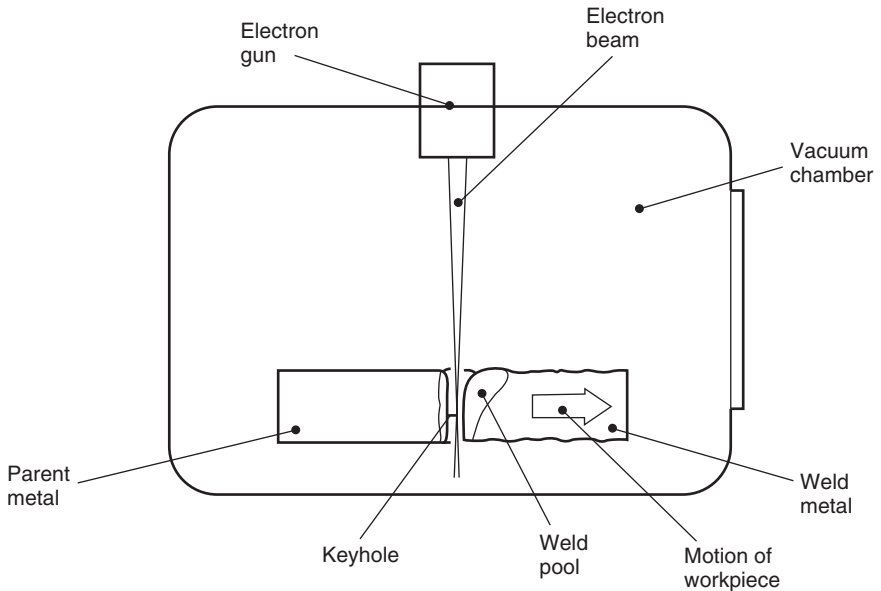

8.9 Principles of electron beam welding, illustrating keyhole welding mode. Courtesy of TWI Ltd.

metal is not normally added but if gaps are present this leads to concavity of the weld face.

The major drawback with this process is the need to carry out the welding in a vacuum chamber evacuated to around  $10^{-3}$  to  $10^{-2}$  Pa. This requires expensive diffusion pumps and a hermetically sealed chamber large enough to accommodate the item to be welded. The cost of equipment, the accuracy with which components have to be machined to provide an accurate fit-up and the time taken to pump the chamber down can make the process non-competitive with more conventional fusion welding processes. For high-precision welding, perhaps of finished machined items where minimal distortion is required and for batch type applications where a number of items can be loaded into the chamber the process is capable of providing excellent results in a cost-effective manner.

Welding the aluminium alloys with the electron beam process presents one problem specific to the process, that of metal vapour from the weld pool causing arcing inside the electron beam gun. This is a particular problem with those alloys that contain low boiling point alloys such as magnesium and zinc. Arcing inside the gun interrupts the beam and causes cavities to be formed in the weld. This problem may be avoided by trapping the vapour by changing the beam path with a magnetic field or by shutting off the beam as soon as arcing is detected and re-establishing the beam

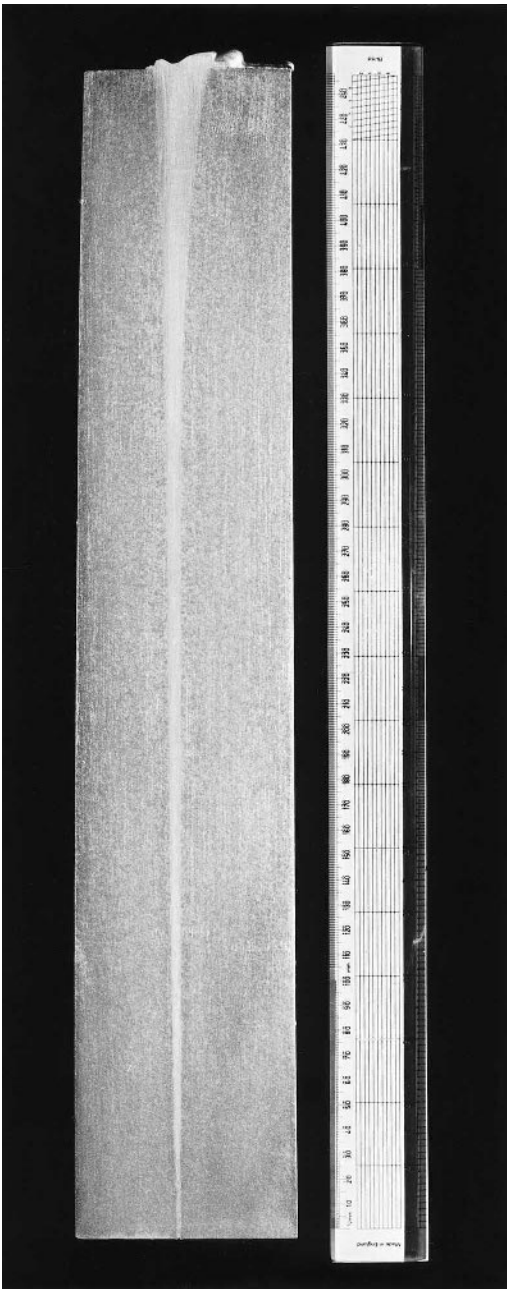

8.10 Single pass electron beam weld in 450 mm thick A5083 alloy. Note the excess weld metal extruded on the weld face due to thermal contraction. Courtesy of TWI Ltd.

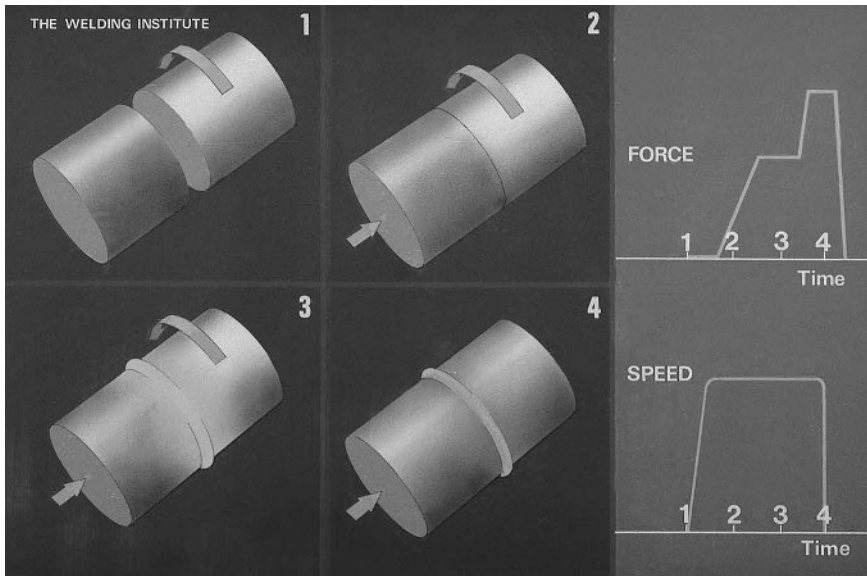

8.11 Conventional rotary motion friction welding. Courtesy of TWI Ltd.

immediately the vapour has dispersed. This can be done extremely rapidly, the weld pool remains molten and cavity formation is avoided. Although some of the alloying elements, i.e. magnesium and zinc, are lost, this is generally insufficient to cause a loss of strength. Elongated cavities in the fade-out region may be produced, particularly in circular components where a run-off tab cannot be used. These may be avoided by careful control of the travel speed and beam fade-out.

The non-heat-treatable alloys can be welded fairly readily without the addition of filler wire but hot cracking problems may be encountered in the more sensitive grades and in the heat-treatable alloys. As with laser welding, wire additions may help. Heat affected zones are small and strength losses are less than would be experienced in a similar thickness arc welded joint.

## 8.5 Friction welding

Unlike the other processes covered in this book friction welding is a solid phase pressure welding process where no actual melting of the parent metal takes place. The earliest version of the process utilised equipment similar to a lathe where one component was held stationary and the other held in a rotating chuck (Fig. 8.11). Rubbing the two faces together produces sufficient heat that local plastic zones are formed and an end load applied to the components causes this plasticised metal to be extruded from the joint,

carrying with it any contaminants, oxides, etc. Thus two atomically clean metal surfaces are brought together under pressure and an intermetallic bond is formed. The heat generated is confined to the interface, heat input is low and the hot work applied to the weld area results in grain refinement. This rapid, easily controlled and easily mechanised process has been used extensively in the automotive industry for items such as differential casings, half shafts and bi-metallic valves. Since the introduction of this conventional rotating method of friction welding many developments have taken place such as stud welding, friction surfacing, linear and radial friction welding, taper plug welding and friction stir welding.

One very important characteristic of friction welding is its ability to weld alloys and combinations of alloys previously regarded as unweldable. It is possible to make dissimilar metal joints, joining steel, copper and aluminium to themselves and to each other and to successfully weld alloys such as the 2.5% copper–Al 2618 and the AlZnMgCu alloy 7075 without hot cracking. The primary reason for this is that no melting takes place and thus no brittle intermetallic phases are formed.

### 8.5.1 Rotary/relative motion friction welding

The rotary/relative motion friction welding process (Fig. 8.11) is suited to the joining of fairly regular shaped components, one of them ideally being circular in cross-section. Equal diameter tubes or bars are the best example since equal heating can take place over the whole contact area. There are a couple of disadvantages to this process. The first is that one of the components must be rotated and this places a restriction on the shape and size of the items to be welded, the second is that items to be welded cannot be presented to the mating part at an angle.

The welding parameters comprise the rotational speed which determines the peripheral speed, the pressure applied during the welding process and the duration of the weld cycle. The metal extruded from the joint forms a flash on the outside of the weld and this is generally machined off to give a flat surface.

### 8.5.2 Friction stir welding

The most significant process for the welding of aluminium to be developed within the last decade of the twentieth century was the friction stir process, an adaptation of the friction welding process. This process was invented at TWI in the UK in 1991 and, unlike the conventional rotary or linear motion processes, is capable of welding longitudinal seams in flat plate. Despite being such a new process friction stir welds have already been launched into space in 1999 in the form of seams in the fuel tanks of a Boeing Delta

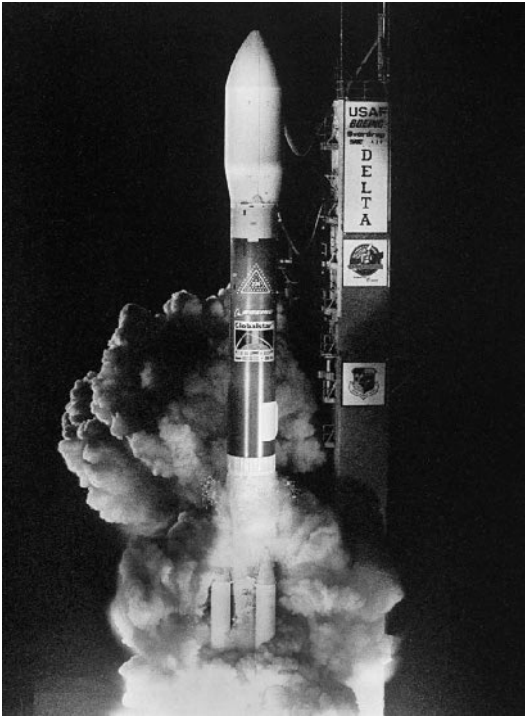

8.12 Launch of a Boeing Delta II Rocket in August 1999 containing friction stir welded joints. Courtesy of TWI Ltd.

II rocket (Fig. 8.12). It will soon be used for non-structural components in conventional commercial aircraft and is being actively considered for structural use. Friction stir welding has also been introduced into shipyards with great success and is being actively investigated for applications in the railway rolling stock and automotive industries.

The process utilises a bar-like tool in a wear-resistant material, for aluminium generally tool steel, a tool lasting in the region of 1–2 km of welding before requiring replacement. The end of the bar is machined to form a central probe and a shoulder, the probe length being slightly less than the depth of the weld required. The bar is rotated and the probe plunged into the weld line until the shoulder contacts the surface. The rotating probe within the workpiece heats and plasticises the surrounding metal. Moving the tool along the joint line results in the metal flowing from the front to the back of the probe, being prevented from extruding from the joint by the shoulders (Fig. 8.13). This also applies a substantial forging force which consolidates the plasticised metal to form a high-quality weld.



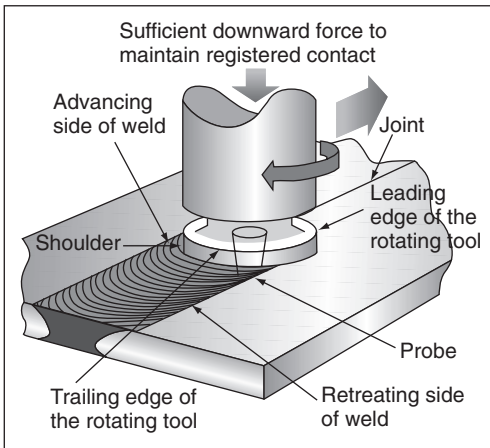

8.13 Principle of the friction stir welding process. Courtesy of TWI Ltd.

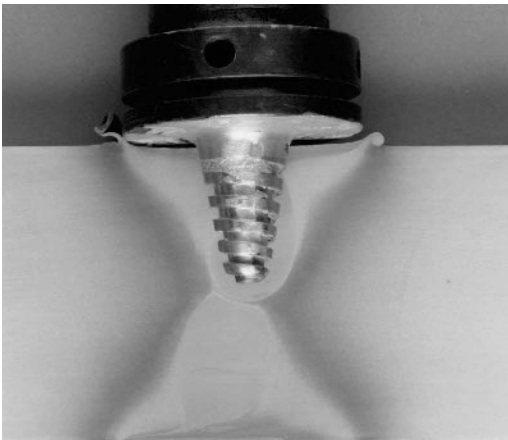

8.14 Macro-section of 75 mm thick A6082 double sided friction stir weld also illustrating a Whorl™ tool tip. Courtesy of TWI Ltd.

To provide support and to prevent the plasticised metal extruding from the underside of the weld a non-fusible backing bar must be used. A groove in the backing bar may be used to form a positive root bead – a simple method of determining that full penetration has been achieved (Fig. 8.14).

The technique enables long lengths of weld to be made without any melting taking place (Fig. 8.15). This provides some important metallurgical advantages compared with fusion welding. Firstly, no melting means that solidification and liquation cracking are eliminated; secondly, dissimilar and



8.15 2 metre long friction stir weld in 10mm thick A6082 alloy.  
Courtesy of TWI Ltd.

incompatible alloys that cannot be fusion welded together can be successfully joined; thirdly, the stirring and forging action produces a fine-grain structure with properties better than can be achieved in a fusion weld and, lastly, low boiling point alloying elements are not lost by evaporation. Other advantages are low distortion, no edge preparation, no porosity, no weld consumables such as shield gas or filler metal and some tolerance to the presence of an oxide layer.

One disadvantage to the process is that the ‘keyhole’ remains when the tool is retracted at the end of the joint. While this may not be a problem with longitudinal seams where the weld may be ended in a run-off tab that can be removed, it restricts the use of the process for circumferential seams. This disadvantage has been overcome by the use of friction taper plug welding. Tools with a retractable pin are also being investigated and have given some promising results.

Alloys that have been welded include the easily weldable alloys 5083, 5454, 6061 and 6082 and the less weldable alloys 2014, 2219 and 7075. In the case of alloys in the ‘O’ condition tensile failures occur in the parent material away from the weld. As far as the effect on the HAZ is concerned heat input is less than that of a conventional arc fusion weld. This results in narrow heat affected zones and a smaller loss of strength in those alloys that have been hardened by cold-working or ageing. Table 8.3 lists the

Table 8.3 Tensile test results for a range of friction stir welded alloys

Material	0.2% proof strength (N/mm <sup>2</sup> )	UTS (N/mm <sup>2</sup> )	Elongation (%)	Softening factor
5083 O	141	298	23	1.00
5083-H321	153	305	22.5	0.91
6082-T6	160	254	4.85	0.83
6082-T6 aged	274	300	8.4	1.00
6082-T4	138	244	18.8	0.93
6082-T4 aged	285	310	9.9	1.19
7108-T79	210	320	12	0.86
7108-T79	245	350	11	0.95

results of mechanical tests carried out by TWI Ltd as part of the investigatory programme. The results show that the 'softening factor', the ratio between the parent metal strength and that of the weld, in both the cold-worked and age-hardened alloys, is close to 1, implying that there is a limited loss of strength.

The softening factors of 0.83 for the 6082-T6 alloy can be compared with the softening factor of 0.50 in Table 4.5 of BS 8118 for an arc weld in the same alloy and condition. The design benefits once this reduction in strength loss can be taken advantage of in the design specifications are obvious.

Plate of 75 mm thickness has been welded using a double sided technique at a welding speed of 60 mm per minute. Plates in the thickness range 1.2–50 mm have been welded in a single pass and at speeds of up to 1800 mm/min. The process is completely mechanical and can be carried out with simple machine tool equipment that requires very little maintenance. The conventional non-destructive testing techniques of radiography and ultrasonic examination do not lend themselves to the interrogation of friction welds. However, the welding parameters are machine tool settings and can be easily monitored and used to determine weld quality, any deviation from the required settings being cause for rejection.

Although this development is relatively recent it has been enthusiastically adopted by the rail rolling stock manufacturers and a number of shipyards in addition to its use in the aerospace industry.

## 9.1 Introduction

Resistance welding is a fusion welding process that requires the application of both heat and pressure to achieve a sound joint. The simplest form of the process is spot welding where the pressure is provided by clamping two or more overlapping sheets between two electrodes (Fig. 9.1). A current is then passed between the electrodes, sufficient heat being generated at the interface by resistance to the flow of the current that melting occurs, a weld nugget is formed and an autogenous fusion weld is made between the plates. The heat generated depends upon the current, the time the current is passed and the resistance at the interface. The resistance is a function of the resistivity and surface condition of the parent material, the size, shape and material of the electrodes and the pressure applied by the electrodes.

There are a number of variants of the resistance welding process including spot, seam, projection and butt welding. It is an economical process ideally suited to producing large numbers of joints on a mass production basis. Spot welding in particular has been used extensively in the automotive industry, albeit mostly for the joining of steel and in the aerospace industry for airframe components in aluminium alloys. Seam welding is used in the production of thin sheet, leak-tight containers such as fuel tanks. Projection welding is generally used for welding items such as captive nuts onto plate. This variation is not normally used on aluminium and is not covered in this chapter. Flash welding, unlike spot and seam welding that require a lap joint, is capable of making butt welds. This is achieved by resistance heating the abutting faces and then forging them together.

There are a couple of characteristics of aluminium that make it more difficult to resistance weld than steel. The most significant is its high electrical conductivity, requiring high welding currents and large capacity equipment. Secondly, the electrodes are made from copper which alloys with aluminium, resulting in rapid wear and a short electrode life.

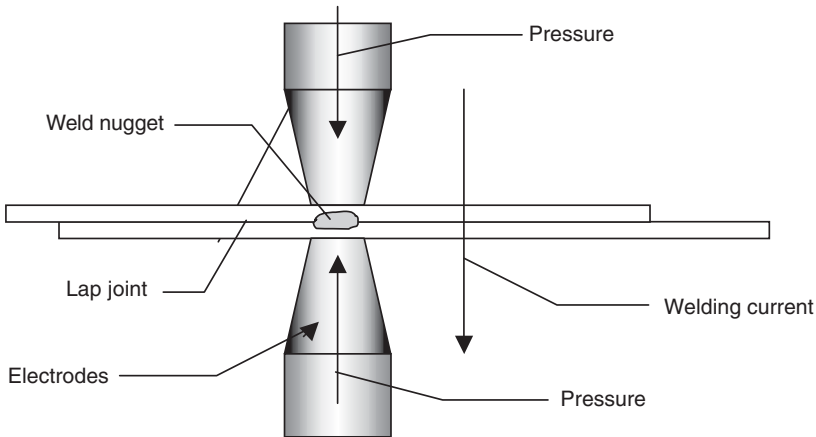

9.1 Principles of spot welding process.

As with conventional fusion welding, resistance welding suffers from similar problems of oxide entrapment and hot cracking, the latter not being helped by the lack of a more crack-resistant filler metal, and porosity.

## 9.2 Power sources

The power sources are normally rated in kV A at 50% duty cycle so, if the maximum primary input power available is known, it is possible to calculate the maximum power output from the welding machine. There are five types of power source commonly used for the welding of aluminium. These comprise single phase AC or DC machines; three phase DC machines with either primary or secondary rectification and inverter units with secondary rectification. The choice of equipment depends on a number of factors such as the primary current available, the output current required, the amount of space required between and around the electrodes, whether the equipment is required to be portable and the equipment cost.

### 9.2.1 Single phase AC units

The power source is simple, robust, relatively inexpensive and maintenance free, comprising little more than a transformer and a suitable timer. For these reasons this form of power source has been popular for low-volume applications. However, the equipment is not very energy efficient as the secondary circuit suffers from substantial inductive losses. Demand on the primary supply is also high and unbalanced between the phases: welding current can be high but the voltage is normally low, between about 3 and 20 volts.

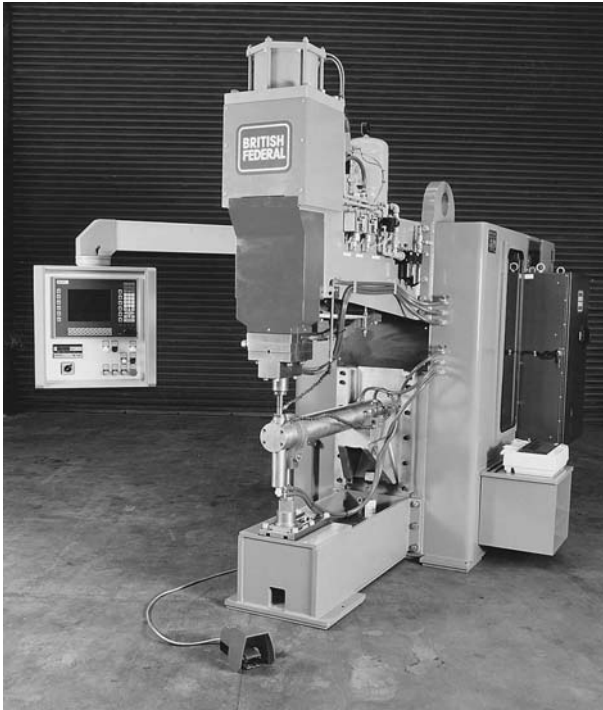

9.2 Modern pedestal mounted spot welder for aerospace applications. Courtesy of British Federal.

The spot welder may be pedestal mounted (Fig. 9.2) or portable. With portable equipment the transformer may be remote from or incorporated into the welding gun. With portable equipment the weight of the transformer makes the gun with the built-in transformer difficult to manipulate even with counterweights to ease manual handling. The gun weight may also exceed the carrying capacity of welding robots. Using a power source remote from the gun requires heavy, stiff cables to deliver the welding current, again making the gun difficult to manipulate.

### 9.2.2 Single phase DC units

Single phase DC units are rather more energy efficient than the single phase AC units as rectification of the current in the secondary circuit reduces losses due to inductance. Power demand across the phases is also more balanced than the single phase units. Although the rectifier adds to the weight the increased efficiency enables a lighter transformer to be used, giving an overall reduction in weight. The equipment cost is greater than the simple

transformer AC unit but an improvement in weld quality can be used to justify this increase.

As with the AC unit the welding gun may be pedestal mounted or portable. The limitations in cables apply when the power source is remote from the gun but the potential for a lighter transformer on gun welding head eases the manipulation problems apparent with the AC units.

### 9.2.3 Primary rectified three phase units

Primary rectified three phase units predate the advent of solid state electronics, using ignitron or thyatron tubes for current control. They were widely used in high-quality applications in industries such as aerospace. Half wave rectification of the primary current is used to provide the transformer with DC to give a high-current, low-voltage output. It is possible to weld a wider range of materials and thicknesses with these more efficient units. The length of the current pulse that these units are capable of providing is limited before saturation of the transformer core occurs. Alternate spot welds are generally made with alternate polarities.

### 9.2.4 Secondary rectified three phase DC units

Secondary rectified three phase DC units are very energy efficient and are capable of delivering very high welding currents, making them ideally suited to the welding of aluminium alloys. They do, however, use very large and heavy transformers and diodes, making the equipment bulky and best suited for fixed and pedestal machines.

### 9.2.5 Secondary rectification inverter units

As mentioned in other chapters the development of solid state electronics, particularly inverter technology, has resulted in highly energy efficient, compact and light power units with weight savings of up to 50% compared with an AC unit of equivalent output. At high current output there is a risk of overheating and up until perhaps 1997 the maximum output was limited to some 20kA but this value has now been increased to over 50kA. This enables these units to be used in high utilisation activities such as those required in the automotive industry and to be mounted on robots for continuous operation (Fig. 9.3).

## 9.3 Surface condition and preparation

The surface condition of the aluminium sheets is one of the most important deciding factors in achieving consistent quality of resistance spot and

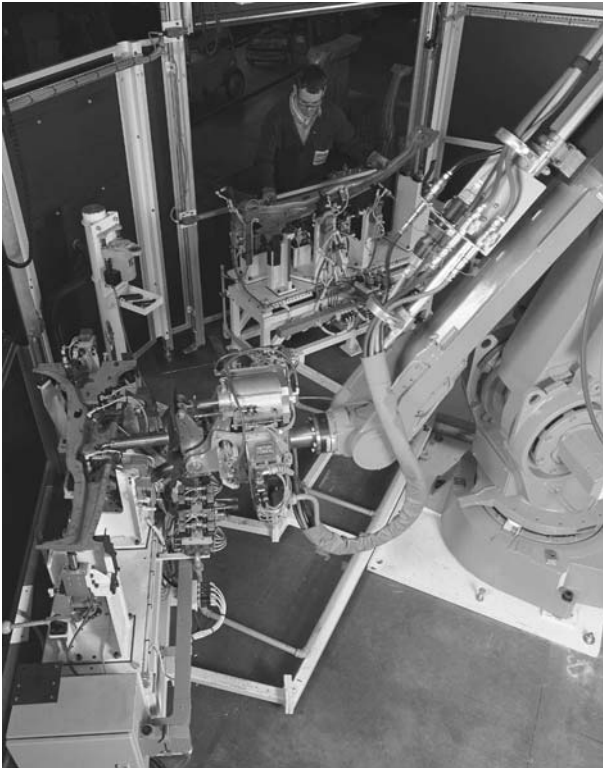

9.3 Modern robotic resistance spot welding cell. The robot welds on one jig while the operator unloads/loads the second jig. Courtesy of British Federal.

seam welds. Variations in the thickness of the oxide film will affect the resistance between both the electrodes and the plates and at the plate interface. The resistance may be measured by clamping a single plate between two electrodes and applying a set current of some 10–15 A, measuring the voltage and calculating the resistance by the use of Ohm's Law. Material as delivered may have a resistance of between 300 and several million microhms, cleaned and prepared plate should have a resistance of 10–100 microhms. For the highest and most consistent quality this range should be tightened to some 10–30 microhms.

To achieve this low level of resistance the cleaning and storage recommendations in Section 4.7 should be followed. Mechanical abraded surfaces generally provide longer electrode lives than chemically cleaned surfaces, with mill finished sheets giving the shortest lives. Special lubricating oils such as polybutene have been used to extend electrode life by reducing the



*Table 9.1* Typical welding parameters for 50Hz equipment single phase AC units. Valid for 1XXX, 3XXX, 5XXX and 6XXX alloys

Sheet thickness (mm)	Electrode diameter (mm)	Dome radius (top) (mm)	Dome radius (bottom) (mm)	Electrode force (kN)	Welding current (kA)	Welding time (cycles)
0.4	16	1.0	Flat	1.4	15	4
0.5	16	1.0	Flat	1.5	18	4
0.65	16	2.0	Flat	1.75	21	5
0.8	16	2.0	Flat	2.2	26	6
1.0	16	3.0	Flat	2.7	30	7
1.25	16	3.0	Flat	3.0	33	7
1.6	16	3.0	Flat	3.35	35	8
1.8	16	4.0	4.0	3.6	35	8
2.0	22	4.0	4.0	3.8	41	8
2.3	22	6.0	6.0	4.25	46	10
2.5	22	6.0	6.0	4.7	56	12
3.2	22	6.0	6.0	5.8	76	12

friction between electrode tip and the sheet but care needs to be taken to ensure that there is not excessive oil present.

## 9.4 Spot welding

### 9.4.1 Spot welding principles and parameters

Spot welding is by far the most widely used variant of the resistance welding process. The basic principles of the technique are illustrated in Fig. 9.1. As many as five overlapping sheets of aluminium may be welded together in a single operation. The weld nugget extends through the sheets but without melting the surfaces of the outer plates. The main welding parameters are current, pressure and time – typical parameters are given in Tables 9.1 and 9.2. It is recommended that when developing a welding procedure the electrode sizes, the welding time and the welding force should be selected first and the welding current increased until the desired nugget size is achieved. Minimum recommended nugget sizes for the thinner of two sheets being welded are as given in Table 9.3.

The welding force required by three phase frequency converter equipment is some 2 to 5 times that of the single phase AC units and for three phase secondary rectified machines somewhere in the region of 0.5 to 2 times. Note that excessive forging force will result in indentation of the sheets, increased distortion and sheet separation. Too low a forging force

*Table 9.2* Typical welding parameters for 50Hz equipment single phase DC units. Valid for 1XXX, 3XXX, 5XXX and 6XXX alloys

Sheet thickness (mm)	Electrode diameter (mm)	Dome radius (mm)	Welding force (kN)	Welding current (kA)	Welding time (cycles)
0.8	16	50	3.5	28	4
1.0	16	75	4.0	32	4
1.6	16	75	5.2	43	7
2.0	22	100	6.5	52	8
2.5	22	150	8.0	60	12
3.2	22	150	11.0	70	12

*Table 9.3* Recommended nugget sizes related to sheet thickness

0.5 mm thick	2.5 mm diameter
0.8 mm thick	3.5 mm diameter
1.0 mm thick	4.0 mm diameter
1.25 mm thick	4.5 mm diameter
1.6 mm thick	5.2 mm diameter
2.0 mm thick	5.7 mm diameter
2.5 mm thick	6.5 mm diameter
3.2 mm thick	7.1 mm diameter

results in metal expulsion, surface burning because of poor contact, tip pick-up or contamination and internal defects of porosity and cracking.

If a forging force is required to assist in consolidating the weld, particularly for the crack-sensitive alloys this should be in the region of 2.5 to 3 times the welding force. Welding current for three phase frequency converter units should be some 30% higher than for the single phase AC units.

A controlled up-slope on the welding current, say over two or three cycles, enables the electrodes to seat on the surface reducing metal expulsion and surface overheating. A down-slope or current decay reduces the rate of solidification and assists in consolidation of the weld nugget if a post-weld forge is used.

#### 9.4.2 Welding head requirements

The welding head may be mounted on a pedestal, a bench, a dedicated machine, a manually operated boom or a robot. The simplest machine is the manually operated pedestal machine but even this may be supplemented with automatic feed and ejection. The pedestal machines are capable of pro-

viding the highest power output, with capacities ranging from 5 to 400 kV A. The portable guns such as those used on robots in the automotive industry generally range in capacity from 10 to 150 kV A. The design of the welding head is important in reducing electrode tip wear, assisting in reducing porosity and cracking and enabling high production rates to be achieved. The head characteristics that affect electrode wear comprise the speed at which the head approaches the job – larger equipment may have a two-speed head that applies the full force only after the initial electrode contact is made. Although tip life is extended the slow approach speed will increase the weld cycle time and reduce production rates. The inertia of the head affects the speed of acceleration and deceleration and ideally the head should be designed to be as light as possible consistent with rigidity. Too much flexure of the arms will result in accelerated electrode wear due to movement between the electrode and the workpiece and unacceptable electrode alignment.

Low inertia is also required during weld pool solidification. As the molten weld metal cools and solidifies, the weld nugget contracts. The electrode must be able to respond rapidly and be capable of following this slight deformation if sound and high-quality welds are to be produced. A ‘squeeze’ is therefore often applied, which assists in consolidating the weld, reducing shrinkage porosity and hot cracking.

### 9.4.3 Welding electrodes

The bulk of the cost of a spot weld is the cost of dressing or replacing the electrode, the life being defined as the number of spot welds that can be made with a pair of electrodes while maintaining a minimum weld nugget diameter. Pick-up of aluminium on to the tip and rapid wear are the two main reasons for the short life of spot welding electrodes. High welding currents, surface finish and electrode forces further assist in shortening the electrode life. It is not uncommon in very high-quality applications such as aerospace for the electrode to require cleaning after as few as 20 spot welds.

Electrode life may be extended by the use of replaceable caps on the electrode tips or, it is claimed, by the use of copper alloys with increased hardness which reduces mushrooming of the tip. Increases in hardness can be achieved by alloying with zirconium or cadmium–chromium and dispersion hardened with aluminium oxide. Of these the 1% Cd-Cu are used for the softer alloys with the harder 1% Cr-Cu or 21% Cr-Zr-Cu alloys for the welding of the cold-worked or age-hardened alloys.

The profile of the electrode tip is important with respect to both the tip life and weld quality. Tips may be conical, truncated conical, flat, domed or cylindrical. Of these types the truncated cone and the dome predominate. The most commonly recommended shape is the domed tip, the shape of

which is more easily maintained in production than the truncated cone. Alignment is also less of an issue and is favoured particularly for portable equipment. The truncated cone tends to be used for commercial quality applications, mainly because electrode alignment is more critical and difficult to maintain consistently in production. Tip life, however, is markedly better, by a factor of two to three, than can be achieved with the domed electrode. Cone angles vary from  $60^\circ$  to  $150^\circ$  including an angle with a slight radius on the tip which aids in alignment and reduces marking of the sheet. The tip profile may be maintained by grinding, filing or by the use of abrasive cloth in a shaped former. While this dressing operation may be performed manually it is difficult to maintain the correct tip shape and electrode alignment. The use of automatic tip dressing tools or specially designed hand-held manual or pneumatic tip dressers is strongly recommended.

Efficient electrode cooling is also necessary to maintain tip life. Large diameter electrodes will provide a greater heat sink but efficient water cooling is imperative. The cooling channel should be carried as close to the tip as possible, a distance of between 12 and 20 mm being usual with water flow rates of 5–10 litres/min. Water inlet temperature should be in the region of  $20^\circ\text{C}$  and the outlet temperature in the region of  $30^\circ\text{C}$ .

#### 9.4.4 Quality control

There is no specification available for the quality control of aluminium spot welds within the UK although ASME IX includes rules for procedure approval of spot welds. There is, however, a British Specification for the spot welding of steel, BS 1140, which contains a multitude of recommendations that may also be applied to aluminium. The main method of demonstrating acceptable quality is by means of the peel test, a simple, inexpensive test, but this may be replaced or supplemented by a tension shear test or a twist test. The test piece for all three tests is essentially the same – two overlapping plates welded together with a single spot. An acceptable result in the peel test is when the weld nugget is pulled out of the parent plate.

Monitoring of the welding parameters is an effective method of assuring quality during production welding. This monitoring may be very simple, detecting only the absence of a weld, or may be a sophisticated electronically based monitor which will both monitor and record current, number of cycles, pressure and time. This recording can be augmented by audible or visual warning of out-of-range welding parameters. Finally, one of the most effective quality control methods is visual inspection where surface melting, adhesion of the electrodes, pits, cracks, asymmetry of the weld spot and

surface indentation can be readily identified. These features may be used to assess the quality of production batches.

## 9.5 Seam welding

Seam welding uses a wheel-shaped electrode (Fig. 9.4) to make either a series of overlapping spot welds to form a continuously welded and leak tight seam or a number of spot welds spaced apart – roll-spot welding. The requirements on electrodes and surface finish are the same as for spot welding. The shunt effect of the closely spaced nuggets and the short weld times mean that higher currents are necessary than for spot welds. Typical welding parameters are given in Table 9.4.

Higher welding forces will be needed for harder alloys and lower values for softer alloys. Welding parameters for three phase frequency converter



9.4 Typical resistance seam welder showing the copper wheel electrodes. Courtesy of British Federal.

**Table 9.4** Seam welding conditions. Single phase AC units. Hardened 5XXX series alloy

Sheet thickness (mm)	Travel speed (m/min)	Spots/ metre	On plus off time (cycles)	On time (cycles)	Welding current (kA)	Welding force (kN)	Weld
0.9	1.02	625	5	1.0	29.0	3.1	3.2
1.0	0.88	550	7	2.0	32.0	3.4	3.5
1.6	0.79	395	10	3.0	38.5	4.3	4.8
2.0	0.64	355	12.5	4.0	41.0	4.8	5.5
2.5	0.55	315	18	5.5	43.0	5.5	6.5
3.2	0.45	275	24	7.0	45.0	6.0	8.0

units are similar to those in Table 9.4 except that welding current needs to be increased by between 0.5 and 2.5 times, the higher values for the thicker materials.

Pick-up on the electrode wheel can be a problem and may require the wheel to be cleaned after only one revolution. Mechanised cleaning systems that remove the contamination in-process by wire brushing or abrasive means have been successful in maintaining continuous production.

## 9.6 Flash butt welding

### 9.6.1 Process principles

As the name suggests flash butt welding is capable of making butt joints in bar-like or tubular components, L, T and X-shaped extrusions, etc. The weld is a solid phase joint where the two ends of the component are forged together at high temperature, any molten metal being expelled from between the two faces (Fig. 9.5). The process takes place in two phases, a ‘flashing’ and an upsetting phase. The two components to be joined are clamped in electrodes, at least one of which is movable. A low-voltage, high-amperage current is applied without the two components being in contact. The parts are then brought together at a controlled rate, resulting in a series of brief short-circuits as the asperities on the faying faces melt and burn off. This continuous series of short-circuits raises the temperature of the ends and expels some of the molten metal, giving the ‘flashes’ that give the process its name.

The heating melts and plasticises the metal and, once sufficient heat has been built up, the ends of the components are forged together, forcing out any melted metal, oxides and contaminants and some of the plasticised material, forming a ‘flash’ or ‘upset’. The expulsion of contaminants and

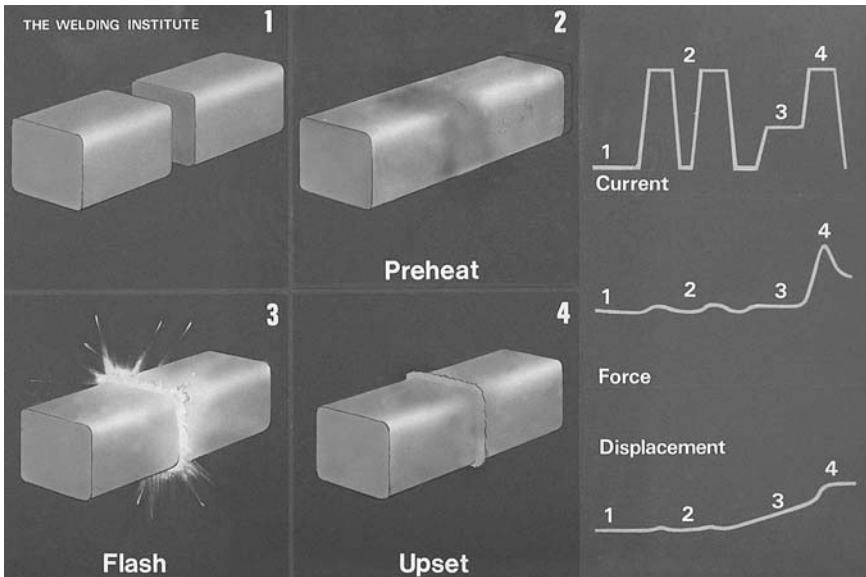

9.5 Principles of flash butt welding. Courtesy of TWI Ltd.

oxides means that pre-weld cleanliness is not as important as the conventional fusion welding processes. The weld is consolidated by this forging action, giving a high-strength joint even in heat-treatable alloys. The forging action also eliminates any cast structure and reduces the width of the HAZ. A monitor chart from a typical weld sequence is illustrated in Fig. 9.6.

### 9.6.2 Welding machines

The basis of the flash welding machine is an AC transformer, the majority of production equipment being single phase machines. The electrodes or clamps are mounted on two rigid platens, at least one of which is movable and powered by a pneumatic or hydraulic system (Fig. 9.7). The capacity of the machine is limited by the current requirements of the joint and the upset pressure available. The power demanded of the transformer is based on the cross-sectional area of the faying faces as a critical current density is required. The varying electrical conductivity of the different alloys also has an effect on power requirements and the range of yield strengths place varying demands on the upset pressure mechanism. As an approximation a machine capable of flash butt welding  $65\text{ cm}^2$  of steel can weld only some  $35\text{ cm}^2$  of aluminium.

The current requirements for flash butt welding range from around 12500 to  $15500\text{ A/cm}^2$  during the upset phase of welding. Current

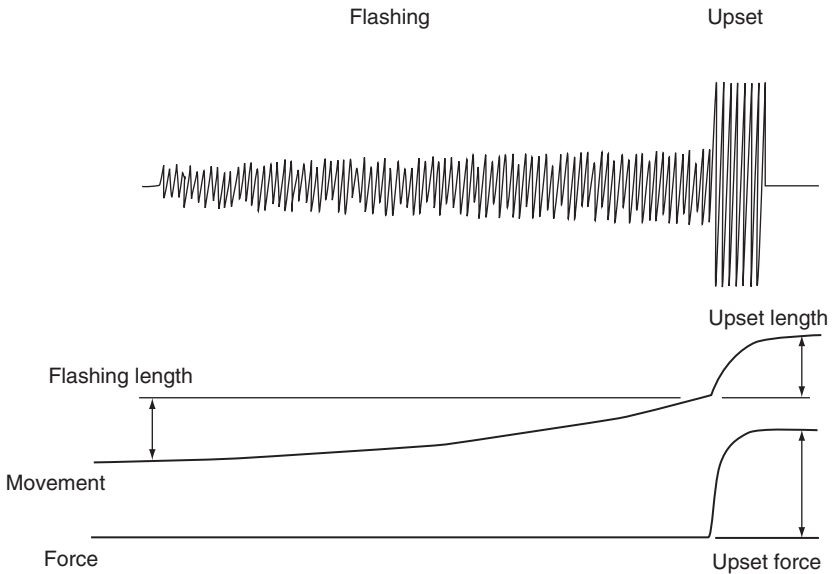

9.6 Typical monitor chart – flash butt welding of cylinder rims.

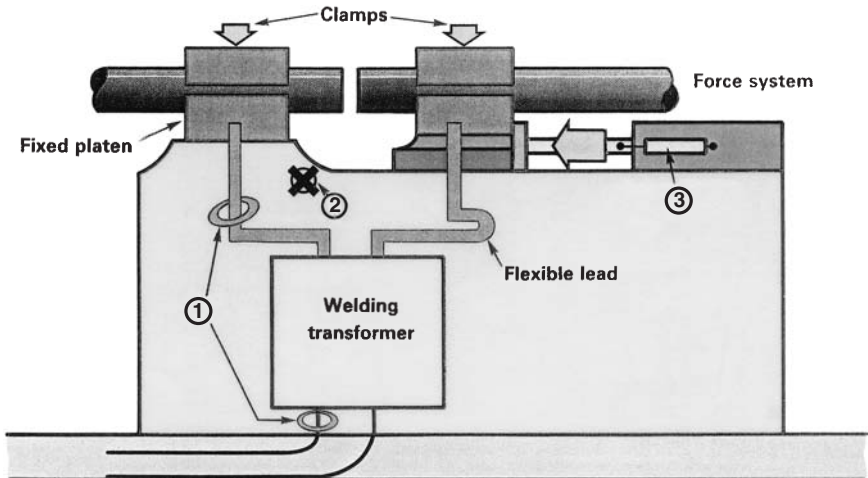

9.7 Schematic of a typical tube or bar flash welding machine.  
1 = current sensing circuit 2 = upset control 3 = pressure transducer.

requirements during the flashing stage will be some 30–50% less than the upset current. Voltages vary from 2 volts at a low cross-sectional area to 20 volts for the thicker sections. The lowest voltage possible should be used consistent with stable flashing for the best results.



### 9.6.3 Electrode clamps

For the welding of steel copper alloys are generally used for the manufacture of the electrode clamps. For aluminium, however, steel, sometimes copper plated, has been found to give better results, conducting less heat away from the weld, providing a longer life and more positive clamping. By drawing the weld back through one of the clamps fitted with a knife edge it is also possible to shear off the upset as part of the removal process. A broach may be inserted into the bore of hollow components to remove any internal flash. To achieve a clean cut and to prevent smearing of the upset during removal the cutting edges must be kept sharp. The clamps are machined to match the outside shape of the components and are split to enable rapid insertion. They are also designed to clamp around 80% of the circumference and to be of a sufficient length that slippage does not occur during upsetting.

To prevent crushing or deformation of hollow components removable inserts or backing devices may be used beneath the clamp area. Sufficient distance must be left between the ends of the inserts to ensure that they do not take part in the welding operation.

### 9.6.4 Quality control

Provided that the equipment is correctly set-up and maintained, flash butt welding is a trouble-free process. Alignment of the components is vital to achieve low rates of weld rejects. Failure to align the components can result in 'shelving' where one component rides up over its partner and in uneven flashing, producing lack of fusion defects. Insufficient heat and/or inadequate upset may both result in lack of fusion type defects or oxide entrapment. Both of these defects can be readily detected by the use of a bend test such as those required by the procedure approval specification BS EN 288 Part 4 – see Chapter 10, Table 10.3. Bend testing is a relatively inexpensive method of assuring weld quality. Those non-destructive test techniques that are commonly used for interrogating arc-welded butt joints, such as radiography or ultrasonic examination, are not suitable for flash butt welding and the engineer is forced to consider destructive tests. Bend testing of pre-production test pieces prior to the start and at the end of a production period of some 8 hours is one of the most cost-effective and easily performed techniques. When this testing is supplemented by in-process monitoring of the welding parameters (Fig. 9.6) then it is possible to demonstrate a 100% acceptable weld quality. While it is written for the control of steel flash butt welding the specification BS 4204 'Flash Butt Welding of Steel Tubes for Pressure Applications' is an extremely useful reference, full of information that may be applied to aluminium alloys. It

gives recommendations on equipment choice, welding sequence control, procedure approval testing and production control testing. In addition there is an example of a flash welding weld procedure record form and a list of information required on a weld procedure specification.

## 10.1 Introduction

Very often the decisions on how a weld should be made, filler metal and welding parameter selection are left to the welder. While this may be acceptable in those situations where the weld quality is only incidental to the integrity of the fabrication it is not acceptable where the weld is crucial to the performance of the component. The need for approved welders to work to approved welding procedures is also often a requirement of either the application standard to which the fabrication is designed and constructed or a contract specification requirement. Aside from these specification requirements it may be necessary for the fabricator to be able to demonstrate to clients, to regulatory authorities or, should a failure leading to loss or damage occur, to a court of law that the welds have been made to an acceptable quality. To specify how both the welds and the welders may be shown to be acceptable there are a number of standards available to the engineer. The requirements of some of these standards are covered in this chapter.

It cannot be emphasised too strongly that the detail below is only a summary of the specification requirements and must be treated with caution. Although best efforts have been made to ensure that the abstracts are accurate, they are only abstracts and accurate at the time of writing. Where compliance is a standard or contract requirement the latest edition of the approval standards *must* be consulted.

## 10.2 Welding procedures

A welding procedure or weld procedure specification (WPS) is a written instruction that specifies materials, consumables and edge preparations for a given joint. It lists the pre- and post-weld operations including heat treatments; machining, grinding and dressing of the weld; details the welding variables and the run sequence; and may specify the acceptance criteria and

inspection methods. The purpose of the WPS is to ensure that acceptance criteria can be met consistently, including mechanical properties and defect levels. It is also useful in enforcing quality control procedures, in standardising on welding methods, production times and costs and in controlling production schedules. Its prime purpose, however, is to give the welder clear, unequivocal instructions on how a weld is to be made. A typical WPS is shown in Fig. 10.1.

In order to confirm that the welding procedure, if followed, is capable of providing the required strength and freedom from defects, the WPS is *approved* or *qualified*. This approval is achieved by welding and testing a test piece representative of the production welds, the welding details and the test results being recorded in a *weld procedure approval record* (WPAR). In the American ASME specifications this is known as a *procedure qualification record* (PQR). Within the WPAR a number of *essential variables* are identified. These essential variables are those features of the procedure that, if changed outside a *range of approval*, will result in an unacceptable change in the mechanical properties or defect level of the weld, invalidating the WPS and making re-approval necessary.

The procedure approval specifications detail the acceptable forms of test pieces, the essential variables and their ranges of approval, test methods and acceptance standards. The most commonly encountered specifications are the European specifications, the EN 288 series and the American specifications, the ASME codes.

### 10.2.1 The BS EN 288 specifications for arc welding approval

The EN series are all entitled ‘Specification and Approval of Welding Procedures for Metallic Materials’.

There are currently 9 parts of the EN specifications as follows:

- Part 1 General Rules for Fusion Welding.
- Part 2 Welding Procedure Specification for Arc Welding.
- Part 3 Welding Procedure Tests for the Arc Welding of Steel.
- Part 4 Welding Procedure Tests for the Arc Welding of Aluminium and its Alloys.
- Part 5 Welding Approval by Using Approved Welding Consumables for Arc Welding.
- Part 6 Approval Related to Previous Experience.
- Part 7 Approval by a Standard Welding Procedure for Arc Welding.
- Part 8 Approval by a Pre-production Welding Test.
- Part 9 Welding Procedure Test for Pipeline Welding on Land and Off-shore Site Butt Welding of Transmission Pipelines.



**ALWELD SERVICES LTD**  
 Granta Park, Great Abington, Cambridge, CB1 6AL  
**EN288 – Manufacturer’s Welding Procedure Specification (WPS)**  
 Weldspec for Windows

Manufacturer's WPS number	036/AL/82/PL	Rev. 02	Examiner or examining body	TWI
WPAR number	005/AL/82/PL	Rev. 0	Method of preparation and cleaning	IN ACCORDANCE WITH CLEANING PROCEDURE CP015/AL
Location	WORKS		Parent metal Specification	AlMg4, 5mNo.7 BS EN 573 P12 AW5083
Manufacturer	ALWELD SERVICES LTD		Composition	
Main welding process	131-MIG		Material thickness (mm)	From 12 To 25
Root welding process	131-MIG		Outside diameter (mm)	From >500 To
Joint type	Butt-plate ss mb			
Welding position	FLAT (FA)			

**Welding preparation details (sketch)\***

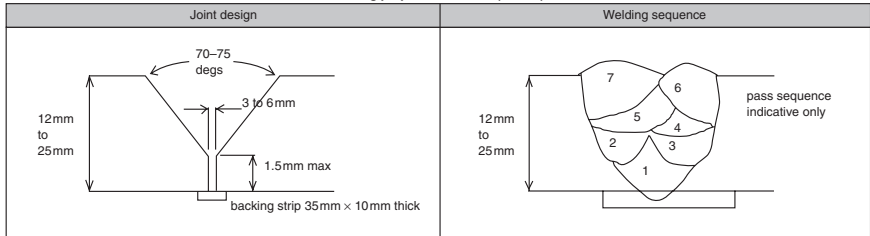

**Welding details**

Run	Process	Size of filler metal (mm)	Current (Amps)	Voltage (volts)	Type of current/ polarity	Wire feed speed (m/min)	Run-out length or travel speed* (mm) or (mm/min)	Heat input* (KJ/mm)
1 to FILL	131 MIG	1.6	325 TO 375	26 TO 31	DC + ve		400 TO 450	

**Welding details**

Filler metal trade name	METRODE ER5556
Filler metal classification	BS 2901 Pt 4 5556A
Baking or drying instructions	NA
Gas or flux type:	Shielding: 99.995% PURE ARGON (DEW POINT < -40C) Backing: NA
Gas flow rate:	(l/min) Shielding: 26 (l/min) Backing: NA
Tungsten electrode type/size	NA
Details of back gouging/backing	A5083 BACKING STRIP 35MM x 10MM THICK
Preheat temperature	(°C) 10 MIN
Interpass temperature	(°C) 200 MAX
Post weld heat treatment and/or ageing	NA
Time, temperature, method	(mins, °C) NA
Heating and cooling rates*	(°C/min) NA

**Other information\***

Weaving (maximum width of run)	(mm)	15
Oscillation: amplitude, frequency, dwell time		NA
Pulse welding details		NA
Distance contact tube/work piece	(mm)	NA
Plasma welding details		NA
Torch angle	(deg.)	NA
Notes		

\*If required

Manufacturer		Examiner or examining body	
Name	Signature	Name	Signature
ALWELD SERVICES LTD		TWI	
Date		Date	
03/Jan/2002		08/Jan/2002	

**10.1 Example of welding procedure specification (WPS) prepared in accordance with BS-EN 288 Part 4.**

Of the 9 parts of the EN 288 specification only Parts 1, 2 and 4 are dealt with in this review.

Part 1 contains definitions and discusses briefly the methods of approval contained in Parts 3 to 8. It also requires WPSs to be prepared in accordance with Part 2.

Part 2 specifies the requirements for the contents of welding procedure specifications for arc welding, listing all of the variables that need to be included and giving instructions as to how the weld shall be made. There is also in Appendix A of the specification a copy of a suggested form for a WPS. See also Fig. 10.1.

Part 4 is the most important part within the series with respect to aluminium. It specifies how a WPS for the welding of aluminium or its alloys shall be approved. It gives the limits of validity of the WPS within the range of variables and includes an example of a WPAR and the accompanying approval certificate. Copies of these are included in Appendix A of the specification. It lists the size and shape of the test pieces and the non-destructive and mechanical tests required to prove the properties of the weld. It covers TIG, MIG and plasma-arc welding processes only, although it may be used as the basis for approving other processes by agreement.

In order to reduce the number of tests required the alloys are formed into groups, each group having similar characteristics as listed in Table 10.1. The test pieces are representative of the joints to be welded in production, comprising plate and pipe butt welds, branch welds and fillets. Test piece sizes are illustrated in Fig. 10.2. The test piece form, type of test and methods and extent of examination of the test pieces are detailed in Table 10.2.

*Table 10.1* Aluminium alloy grouping system

Group	Type of alloy
21	Pure aluminium Aluminium with less than 1.5% impurities, e.g. 1050, 1080, 1200, 1350 Aluminium with less than 1.5% alloy additions, e.g. 3103
22	Non-heat-treatable alloys divided into two groups:
22.1	Aluminium–magnesium alloys with 3.5% Mg or less, e.g. 3105, 5005, 5052, 5154, 5454
22.2	Aluminium–magnesium alloys with between 4% and 5.6% Mg, e.g. 5083, 5182, 5086
23	Heat-treatable alloys. These include the Al-Mg-Si and the Al-Zn-Mg alloys, e.g. 6060, 6063, 6082, 6463, 7020, 7022, 7075

Table 10.2 Test regime to BS EN 288 Part 4

Test piece form	Type of test	Extent of testing	
1	Butt	Visual examination to EN 970	100%
		Radiography or ultrasonics	100%
		Penetrant examination to EN 571-1	100%
		Transverse tensile test to EN 895	2 specimens
		Transverse bend test to EN 910	2 root 2 face at and over 12 mm thick 4 side bend coupons may be substituted for the root and face bends
		Macro-examination to EN 1321	1 section
		Micro-examination to EN 1321	1 section (only for material groups 22 and 23)
2	Branch	Visual examination to EN 970	100%
		Penetrant examination to EN 571-1	100%
		Radiography or ultrasonics	100%
			At and below 50 mm diameter radiography or ultrasonics is not mandatory
			Macro-examination to EN 1321
		Micro-examination to EN 1321	1 section (only for material groups 22 and 23)
3	Fillet	Visual examination to EN 970	100%
		Penetrant examination to EN 571-1	100%
		Macro-examination to EN 1321	2 sections
		Micro-examination to EN 1321	1 section (only for material groups 22 and 23)

The range of approval for dissimilar metal joints is also covered. This is not included in this chapter – for details reference should be made to clause 8.3.1.2 of the specification. The position of the specimens within the test piece is also illustrated in Fig. 10.2. Note that the bend coupon radius varies depending upon the material group and the condition or temper of the test piece as given in Table 10.3. Note also that allowance for strength loss in the cross joint tensile test in cold worked or age hardened alloys is allowed for in Table 2 of the specification.

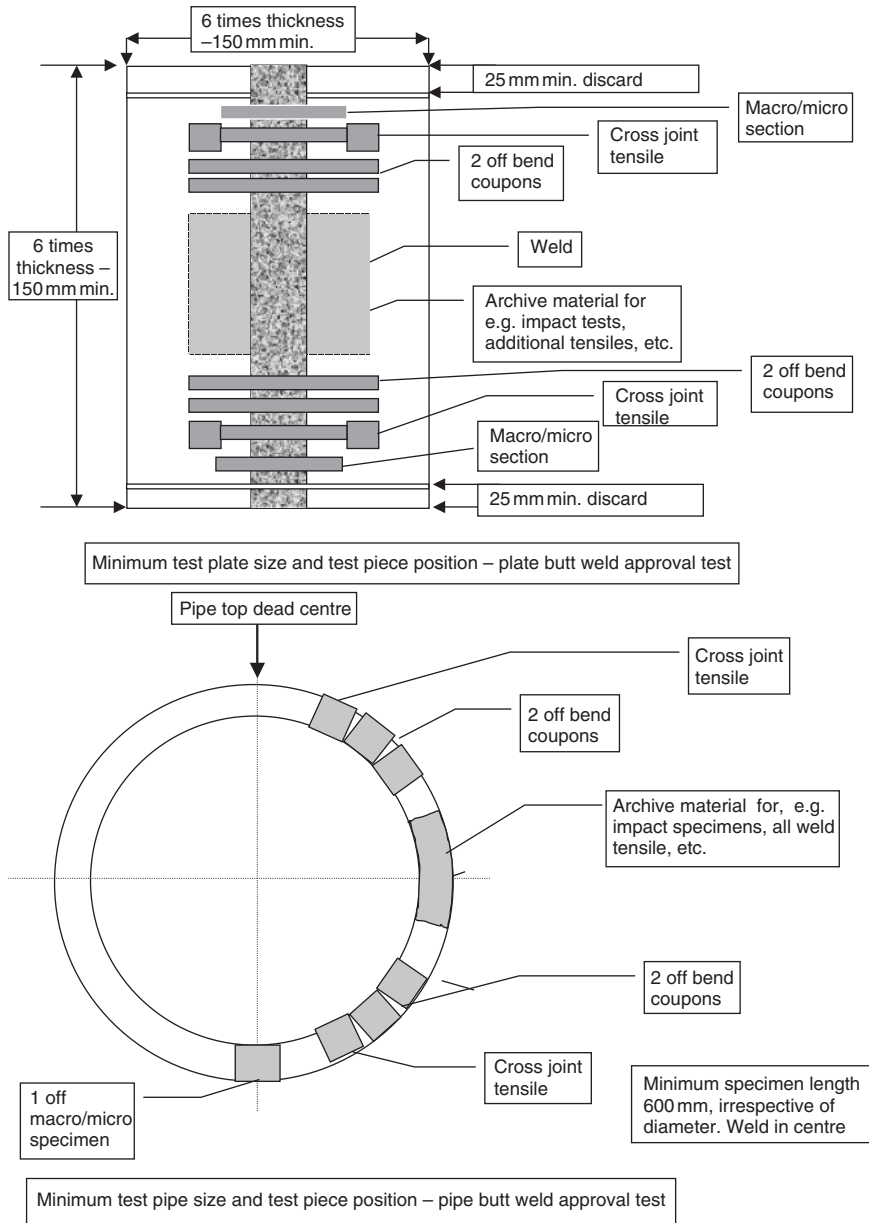

10.2 Test piece positions for approval testing to BS EN 288 Part 4.



Table 10.3 Bend coupon testing requirements – BS EN 288 Part 4

Material group	Former diameter								
	O	F	H14	H16	H18	H19	T4	T5	T7
Temper or condition		H112 H12 H22 H32	H24 H34	H26 H36	H28 H38	H29 H39		T6	
21	2t	3t	3t	3t	4t	4t	—	—	—
22.1	3t	3t	3t	4t	5t	5t	—	—	—
33.2	6t	6t	6t	6t	6t	6t	—	—	—
23	4t	—	—	—	—	—	6t	7t	8t

t = the bend coupon thickness.

Table 10.4 Thickness approval range

Test piece thickness $t$	Range of approval	
	Butt, T-butt, branches, single run, one or both sides	Butt, T-butt, branches, multi-run, all fillets
$t \leq 3$	$0.8t$ to $1.1t$	$t$ to $2t$
$3 < t \leq 12$	$0.8t$ to $1.1t$	$3$ to $2t$
$12 < t \leq 100$	$0.8t$ to $1.1t$	$0.5t$ to $2t$ (max. 150)
$t > 100$	$0.8t$ to $1.1t$	$0.5t$ to $1.5t$

All dimensions in millimetres.

The ranges of approval of the essential variables are given in Clause 8 of the specification and comprise the following:

- The manufacturer. The approval is restricted to the manufacturer and workshops or sites under his technical and quality control. *Procedure approval cannot be sub-contracted to a third party or transferred between fabricators.*
- The parent metal. In order to reduce the number of tests required the alloys have been formed into groups with similar characteristics, as shown in Table 10.1.
- Parent metal thickness is approved over a range dependent upon the test piece thickness. For the purposes of this the thickness is regarded (1) as the thinner of the two materials when dissimilar thicknesses are welded in a butt joint; (2) as the thinner of the two materials in a fillet weld; (3) as the thickness of the branch for a set-on branch; and (4) as the thickness of the main pipe for a set-in or set-through branch (Table 10.4).

There is a footnote to the table in the specification that infers that, where a multi-process procedure is used to make the joint, the approval range of thickness of weld metal from the individual processes should be based on the approval range given in the table. The range of approval for a fillet weld is based on the throat thickness of the test piece and is given as  $0.75a$  to  $1.5a$  where  $a$  is the throat. A test piece throat thickness of 10mm or more approves all fillet welds over 10mm throat.

An important point to remember is that a fillet weld approval provides no information on the mechanical properties of a joint. Where the fillet weld is to be load carrying it is necessary to perform a butt weld approval so that tensile data are available for design purposes.

- Test piece diameter is also an essential variable when welding pipes, tubes or hollow sections. Below 168.3mm outside diameter the approval range is  $0.5D$  to  $2D$  where  $D$  is the test piece diameter. At and above 168.3mm OD the range is  $0.5D$  to flat plates.
- Welding position has a range of approval based on the ease of making the joint. For example, a pipe butt weld made in the vertical-up (PF) position approves for all positions except vertical-down (PG). Similarly there is a range of approval for joint type with an unbacked butt joint in pipe approving for all other butt and fillet welds. For full details of these ranges reference should be made to Tables 8 and 9 in the specification. A sketch explaining the welding positions and how they are designated is included as Fig. 10.3.
- Other essential variables comprise the welding process; filler metal classification; type of current; heat input when specified; preheat and interpass temperature; post-weld heat treatment or ageing; the type of both shielding and backing gases; and the number of filler wires in MIG welding.

Once the procedure is approved and the WPAR is written the approval remains valid indefinitely provided that none of the essential variables are changed outside of their range of approval. This approval enables any number of welding procedures or work instructions to be written, provided that the variables specified in the WPS are within the range of approval of the WPAR.

While the best effort has been made to provide an accurate summary of BS EN 288 Part 4 and the information is correct at the time of writing it is recommended that the specification is referred to when there is a requirement to comply in the application standard or in contractual documents.

### 10.2.2 ASME IX welding and brazing qualifications

The principles of approval testing in this ASME code are very similar to those adopted for the EN specifications. There are testing requirements for

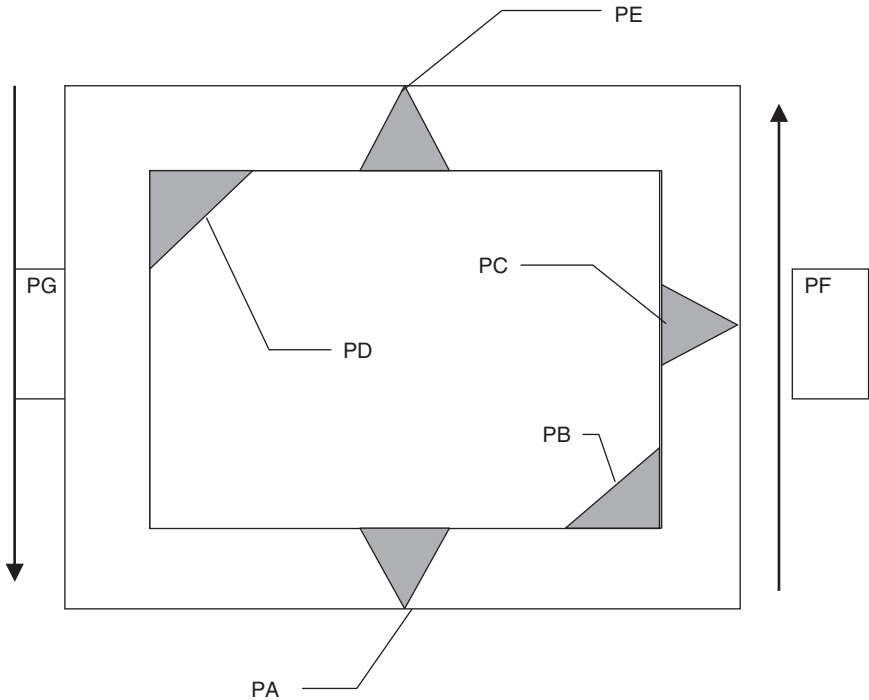

10.3 Welding position designations in accordance with EN 288.

standard test pieces, a list of essential and non-essential variables and the corresponding ranges of approval. ASME IX, however, covers a wider range of welding processes, including all of the arc welding processes, laser and electron beam welding, electro-slag and electro-gas welding, stud welding, friction welding and oxy-gas welding. It also covers brazing approvals, brazing operator and welder approvals.

The essential variables in the ASME code are as follows:

- The alloys are grouped under 'P' numbers, the members of a P-number group having similar characteristics as listed in Table 10.5. Approval of one alloy in the group approves for all the others in the group, a change in the P-number requires re-approval. Alloys not listed are 'unassigned'. This means that the alloy has not been grouped and the specific alloy has to be individually approved.
- Filler metals are grouped under 'F' numbers in a similar manner to the parent metals. The groups are given in Table 10.6.
- Thickness and joint type are essential variables. A butt weld approves a fillet weld but not vice versa, the approval range on thickness

Table 10.5 Parent metal 'P' number grouping

Group no.	Alloys in group
P21	1060, 1100, 3003
P22	3004, 5052, 5154, 5254, 5454, 5652,
P23	6061, 6063,
P25	5083, 5086, 5456,

Table 10.6 Filler metal grouping

F number	Filler metals in group
F21	E/ER1100, ER1188, E3003
F22	ER5554, ER5356, ER5556, ER5183, ER5654
F23	ER4009, ER4010, ER4043, ER4047, ER4145, ER4643
F25	ER2319

Table 10.7 Test pieces and approval range

Test piece thickness approved	Range of thickness ' $T$ ' approved	Range of weld metal thickness $t$	Test specimens
<1.6 mm	$T$ to $2T$ tensiles	$2t$	2 cross joint 2 root 2 face bends
1.6–9.6 mm	1.6 mm to $2T$	$2t$	2 cross joint tensiles 2 root 2 face bends
>9.6–19.2 mm	4.8 mm to $2T$	$2t$ ( $t < 19.2$ mm) $2T$ ( $t \geq 19.2$ mm)	2 cross joint tensiles 4 side bends
38.1 mm and over	4.8 mm to 203.2 mm	$2t$ ( $t < 19.2$ mm) 203.2 mm ( $t \geq 19.2$ mm)	2 cross joint tensiles 4 side bends

depending upon the test piece thickness as in Table 10.7. Fillet welds can be approved by fillet test pieces sectioned to provide macro sections only. The thickness range approved is unlimited.

- The welding position and the welding preparation are not essential variables.
- The addition or deletion of or a change in the shielding gas in the gas shielded processes requires a re-approval.
- The approval is limited to the manufacturer and sites under his or her direct control.

## 10.3 Welder approval

While the procedure approval test is performed to demonstrate acceptable mechanical properties, the welder approval test is carried out to demonstrate that the welder has a sufficient level of skill to deposit weld metal of an acceptable quality. A similar philosophy to that for procedure approval is adopted – a number of standard tests are called up in the standards, successful completion of which gives a range of approval for a number of essential variables. Since the purpose of the test is to assess the skill of the welder the essential variables are different from those of the procedure approval test. The specifications most frequently encountered are BS EN 287 Part 2 and ASME IX.

### 10.3.1 BS EN 287 Part 2

BS EN 287 Part 2 complements the procedure approval specification BS EN 288 Part 4. The specification regards the welding process as an essential variable and restricts the processes covered by the specification to MIG, TIG and plasma-arc welding although other processes may be approved by agreement (Table 10.8).

Materials are grouped for the purposes of approval as follows:

- Group W21, pure aluminium and aluminium–manganese alloys with less than 1.55 Mn;
- Group W22 non-heat-treatable alloys;
- Group W23 heat-treatable alloys.

Dissimilar metal joints are treated in a similar manner with a test piece made in one group conferring approval to weld a number of combinations as shown in Table 10.9.

*Table 10.8* Material groups for which the welder is approved

Test piece material group	Range of approval		
	W21	W22	W23
W21	*	X	—
W22	X	*	—
W23	X	X	*

\* Approved group.

X Group also approved.

— Not approved.

*Table 10.9* Range of approval for dissimilar metal joints

Test piece material group	Range of approval
W21	W21 welded to W22
W22	W22 welded to W21
W23	W22 welded to W21
	W23 welded to W21
	W23 welded to W22

The filler metal must correspond to one of the parent metal groups.

*Table 10.10* Range of approval on thickness

Test piece thickness $t$ (mm)	Range of approval
$t \leq 6$	$0.7t$ to $2.5t$
$6 < t \leq 15$	$6\text{ mm} < t \leq 40\text{ mm}$

Over 40mm thick a test at the specific thickness is required.

An approval test on wrought material gives approval to weld both cast and wrought alloys within the same group and combinations of wrought and cast material. Any alloys not contained within the grouping system must be approved individually.

The approval range for the filler metal and the shield gas is not perhaps as clear as that with the parent metal groups. A test made with a specific filler metal and shielding gas gives approval to weld with any other filler metal compatible with the parent metal group provided that there is no change in the process or shield gas and that this does not require a change in the welder's technique. This last variable is unfortunately not quantified.

Thickness and pipe diameter are both essential variables; the ranges of approval are given in Tables 10.10 and 10.11.

Joint type is an essential variable. An approval test on a pipe also approves the welder for welding plate; a plate approval for welding pipe of over 500mm; a plate butt weld made in the flat (PA) or horizontal-vertical position (PC) position approves for butt joints in pipes of 150mm or more in diameter welded in similar positions. A butt weld approves a fillet weld. Welding a backed test piece approves a double sided joint with a back-gouge but not for unbacked joints.

An approval test with a specific filler metal and gas combination approves the welder to weld with any filler metal and gas that are compatible with

Table 10.11 Range of approval on diameter

Test piece diameter $D$ (mm)	Range of approval
$D \leq 125$	$0.5D$ to $2D$
$D > 125$	$\geq 0.5D$

For structural hollow sections ' $D$ ' is the dimension of the smaller side.

the parent metal, provided that this does not require a change in the welder's technique.

The last and perhaps the most important variable from the welder's point of view is the welding position as shown in Table 10.12, the principle being that a test carried out in a more difficult position approves for welding in the easier positions. The specification requires that the test is carried out with conditions similar to those to be used in production such as edge preparation, position, welding time, preheat and heat input. The test piece must have at least one stop and start in both the root run and in the capping pass.

The test regimes for the various types of joint are given in Table 10.13.

The acceptance standard is specified in EN 30042 'Guidance on Quality Levels for Imperfections' and is specified as defect level 'C' for excess weld metal, excess convexity, excess throat thickness and penetration and level 'B' for the remaining defects.

The welder may submit a second test piece if the first fails to achieve the required standard. If this test piece also fails and the failure can be attributed to a lack of skill then the welder is required to be re-trained before being permitted to attempt the test once more. Successful completion of a test approves the welder for a period of two years although the approval certificate must be endorsed at six monthly intervals by the employer. This can be done provided that the welder is engaged on work within the range of approval and that the work is of an acceptable quality. The period of approval can be extended beyond two years by the examining body provided that the employer can produce documentary evidence such as six monthly radiographic, ultrasonic or fracture test reports.

### 10.3.2 ASME IX welder approval

The ASME code covers both procedure approval (qualification) and welder approval. Welders are divided into two categories, those who perform manual or semi-automatic (MIG) welding and those who operate machine or automatic welding equipment. As with EN 287 Part 2 the welder must

Table 10.12 Approval related to test weld position

Welding position of approval test piece				Range of approval								
				Plates								
				Butt welds					Fillet			
				PA	PC	PG	PF	PE	PA	PB		
Plates	Butt welds			PA	*	—	—	—	—	×	×	
				PC	×	*	—	—	—	×	×	
				PG	—	—	*	—	—	—	—	
				PF	×	—	—	*	—	×	×	
				PE	×	×	—	×	*	×	×	
	Fillet welds			PA	—	—	—	—	—	*	—	
				PB	—	—	—	—	—	×	*	
				PG	—	—	—	—	—	—	—	
				PF	—	—	—	—	—	×	×	
				PD	—	—	—	—	—	×	×	
Pipes	Butt welds pipe-axis and angle		rotating	0°	PA	×	—	—	—	—	×	×
					PG	—	—	×	—	—	—	—
			PF		×	—	—	×	×	×	×	
			fixed	90°	PC	×	×	—	—	—	×	×
				45°	H-L045	×	×	—	×	×	×	×
	Fillet welds pipe-axis and angle		rotating	45°	PA	—	—	—	—	—	×	—
					PB	—	—	—	—	—	×	×
			fixed	0°	PG	—	—	—	—	—	—	—
					PF	—	—	—	—	—	×	×

1) PB for pipes may be welded in two versions.

(1) pipe: rotating; axis: horizontal; weld: horizontal vertical.

(2) pipe: fixed; axis: vertical; weld: horizontal vertical.

2) This is an approved position and is covered by the other related tests.

Key

\* indicates the welding position for which the welder is approved in the approval test.

× indicates those welding positions for which the welder is also approved.

— indicates those welding positions for which the welder is not approved.

Reproduced with the permission of BSI under licence no. 2002 SK/0151. British Standards can be obtained from BSI Customer Services, 389 Chiswick High Road, London W4 4AL.



Pipes													
welds			Butt welds					Fillet welds					
			Pipe-axis and -angle										
			rotating		fixed			rotating		<sup>1)</sup>	fixed		
			0°		90°	45°	45°		0°	90°			
PG	PF	PD	PA	PG	PF	PC	H-L045	PA	PB	PG	PF	PD <sup>2)</sup>	
—	—	—	×	—	—	—	—	×	×	—	—	—	
—	—	—	×	—	—	×	—	×	×	—	—	—	
×	—	—	—	—	—	—	—	—	—	—	—	—	
—	×	—	×	—	—	—	—	×	×	—	×	—	
—	×	×	×	—	—	—	—	×	×	—	×	×	
—	—	—	—	—	—	—	—	×	—	—	—	—	
—	—	—	—	—	—	—	—	×	×	—	—	—	
*	—	—	—	—	—	—	—	—	—	—	—	—	
—	*	—	—	—	—	—	—	×	×	—	—	—	
—	×	*	—	—	—	—	—	×	×	—	—	×	
—	—	—	*	—	—	—	—	×	×	—	—	—	
×	—	—	—	*	—	—	—	—	—	×	—	—	
—	×	×	×	—	*	—	—	×	×	—	×	×	
—	—	—	×	—	—	*	—	×	×	—	—	—	
—	×	×	×	—	×	×	*	×	×	—	×	×	
—	—	—	—	—	—	—	—	*	—	—	—	—	
—	—	—	—	—	—	—	—	×	*	—	—	—	
×	—	—	—	—	—	—	—	—	—	*	—	—	
—	×	×	—	—	—	—	—	×	×	—	*	×	

Table 10.13 Test regime for welder approval

Test method	Butt weld plate	Butt weld pipe	Fillet weld
Visual	Yes	Yes	Yes
Radiography	Yes <sup>1</sup>	Yes <sup>1</sup>	Not mandatory
Bend or tensile	Yes <sup>2</sup>	Yes <sup>2</sup>	Not mandatory
Fracture	Yes <sup>1</sup>	Yes <sup>1</sup>	Yes <sup>3,4</sup>
Macro (unpolished)	Not mandatory	Not mandatory	Not mandatory <sup>4</sup>
Penetrant	Not mandatory	Not mandatory	Not mandatory

1 Radiography or fracture test, not both.

2 A tensile test may be used instead of a bend test for alloys with low ductility. A bend or tensile test must be carried out if the MIG welding process (131) is used.

3 The examining body may request additional macro-testing and penetrant examination.

4 The fracture test may be replaced by at least 4 macro-sections.

Table 10.14 List of variables for welder approval to ASME IX

Main variable	Clause number	Variables	GMAW	GTAW	PAW
Joint detail	QW402.4	Delete backing	Yes	Yes	Yes
	QW402.7	Add backing	No	No	No
Base metal	QW403.2	Thickness	No limit	No limit	No limit
	QW403.16	Pipe diameter	Yes	Yes	Yes
Filler metal	QW403.18	P material group	Yes	Yes	Yes
	QW404.14	± Filler	NA	Yes	Yes
	QW404.15	Change F No.	Yes	Yes	Yes
	QW404.22	± Inserts	NA	Yes	Yes
Weld position	QW404.30	Change in $t$	Yes	Yes	Yes
	QW405.1	Add position	Yes	Yes	Yes
Gas	QW405.3	$V_{up}$ vs $V_{down}$	Yes	Yes	Yes
	QW408.8	Delete backing	Yes	Yes	Yes
Electrical	QW409.2	Change transfer mode	Yes	NA	NA
	QW409.4	AC to DC	NA	Yes	NA
	QW409.4	DC+ to DC-	NA	Yes	NA

$t$  is the weld deposit thickness.

be provided with a written welding procedure. There are a number of essential variables for three of the processes relevant to aluminium as shown in Table 10.14. For information on the range of approval of the essential variables reference should be made to the clause listed in Table 10.14, to be found in ASME IX.

Approval testing for a butt (groove) weld is by bend testing although this may be replaced by radiography – it is permitted to use the first production weld made by the welder for this approval. Qualification for a fillet weld is by macro-examination and fracture testing.

The approval is valid for a period of six months. Provided that the welder welds with the relevant process within this six month period the approval can be extended indefinitely unless there is any reason to question the welder's competence.

### 10.3.3 BS EN 1418 welding personnel – approval testing

BS EN 287 Part 2 covers the approval of manual welders – BS EN 1418 has been produced to specify how operators of mechanised or automated equipment should be approved. The full title of the specification is 'Welding Personnel – Approval testing of welding operators for fusion welding and resistance weld setters for fully mechanized and automatic welding of metallic materials'. The specification makes it clear that only those operators responsible for setting up and adjusting operating parameters *during* welding need to be approved. Programmers of equipment who do not actually operate the equipment in production are not required to be approved, nor are resistance welding operators.

Definitions are given in clause 3 where:

- Automatic welding is defined as welding operations where all parameters are pre-set and cannot be adjusted during welding.
- Mechanised welding is where all of the activities are performed automatically but the welding variables can be changed during welding.
- Robotic welding is defined as automatic welding using a pre-programmed manipulator.

The welding operators or resistance weld setters may be approved by one of four methods:

- By performing the welding procedure test specified in EN 288 Part 3 or 4.
- By performing a pre-production or production welding test. This test may be carried out on non-standard test pieces, on test pieces simulating production or on actual production items that have been identified as test pieces prior to welding. Testing is to the requirements of EN 288 Part 8.
- By taking actual production items for testing. As in the point above testing is to the requirements of EN 288 Part 8.
- By performing a function test. In this the operator/resistance weld setter is required to know the relationship between parameter deviations and

welding results, to set and control the parameters in accordance with an approved welding procedure, to test the operation of the welding unit and to be capable of recognising and reporting any malfunctions. Annex B of the specification gives information of what knowledge the operator/resistance weld setter would typically be expected to have.

Provided that the operator/resistance weld setter successfully completes one of the above tests then there is no limit to their range of approval. This is provided that they continue to work with the same type of welding unit, the welding process is not changed and they work in accordance with an approved procedure. Automatic and robotic welding approval using a multi-run technique gives approval for welding with a single run but not vice versa; approval to weld without a sensor gives approval for welding with a sensor but not vice versa; changing the robot type, system or control unit requires re-approval as does any change to the other essential variables.

Provided that the operator/resistance weld setter works with reasonable continuity, i.e. no break is longer than six months, and there is no reason to question their competence then the approval is valid for a period of two years. The employer must endorse on the approval certificate at six monthly intervals that this is so. If the employer keeps records of non-destructive or mechanical tests carried out at a maximum of six month periods and these confirm that the required quality is being maintained then the examining body can endorse the approval certificate at the end of the two year validity period for further periods of two years.

## 11.1 Introduction

Previous chapters have covered those defects and losses in strength that may be described as arising from metallurgical effects. This chapter covers those defects that may be described as defects of geometry, their causes and the non-destructive testing techniques that may be used to detect them. Many of these defects are caused by the welder, because of either a lack of care or a lack of skill, and emphasise the need for adequate training. Similarly, if non-destructive testing is to be correctly performed and defects accurately identified and sized, well-trained and experienced non-destructive evaluation (NDE) operatives are needed. A simple and inexpensive non-destructive examination technique that is sometimes overlooked is that of a thorough visual examination by a suitably trained and experienced welding inspector. Such an examination will identify many defects, particularly those of shape as listed in Section 11.2 below.

## 11.2 Defects in arc welding

A list of weld defects and their causes is given in Table 11.1. Other defects not listed are mainly those of geometry and include misshapen and incorrectly sized welds, variable cap width and height, weld face roughness, incomplete weld fill and asymmetry of fillet welds. These are all welder-induced problems, requiring improved shop-floor discipline and/or welder retraining.

If the required acceptance level for the defects listed above is not contained within a relevant application standard then it is the responsibility of the designer to select the appropriate quality level. A readily available specification to which the designer may refer for guidance is BS EN 30042 'Arc Welded Joints in Weldable Alloys, Guidance on Quality Levels for Imperfections'. This document contains three quality levels, B stringent, C intermediate and D moderate, the choice of which depends upon design considerations, subsequent fabrication activities such as rolling or pressing,

Table 11.1 Weld defects, description and causes

ISO 6520 Defect no.	Defect Name	Description	Causes
4011 (Fig. 11.1)	Lack of side wall fusion	Failure of weld metal to fuse to weld preparation	Current too low, travel speed too high, incorrect torch angle, oxide film on prep. surfaces, inadequate joint cleaning, weld preparation too narrow
4012 (Fig. 11.1)	Lack of inter-run fusion	Failure of weld metal to fuse to preceding run	Current too low, travel speed too high, incorrect torch angle, inadequate inter-run cleaning
4013 (Fig. 11.1)	Lack of root fusion	Root bead fully penetrated but not fused to root face	Current too low, voltage too low, travel speed too high, root face too thick, root gap too wide, incorrect torch angle, inadequate cleaning
517	Poor restart (cold start)	Lack of fusion beneath weld start position	Incorrect welder technique (see Section 7.4.1), poor earthing
402	Lack of penetration	Failure to achieve the minimum penetration specified by design	Current too low, travel speed too high, incorrect torch angle, incorrect weld prep.
4021 (Fig. 11.2)	Insufficient (lack of) root penetration	Failure of weld metal to penetrate fully root faces	Current too low, travel speed too fast, root face too thick, root gap too small, incorrect torch angle, misalignment
504 (Fig. 11.3)	Excess penetration	Unacceptable protrusion of the root bead	Current too high, travel speed too slow, root gap too wide, root face too thin
501 (Fig. 11.4)	Root or face undercut	Notch parallel to weld at weld toe. Prevalent at top edge of PB fillet	Current too high, travel speed too fast, incorrect torch angle, inadequate cleaning
502 (butt)	Excess convexity	Excess weld metal on the face of a	Current too high, travel speed too low,

503 (fillet) (Fig. 11.5)	Excess weld metal (excess cap height)	butt or fillet weld	incorrect torch manipulation
511 (Fig. 11.6)	Incomplete fill (face concavity or missed edge). Insufficient throat in fillet welds	Insufficient weld metal fill giving groove on weld face resulting in insufficient throat	Poor welder technique, travel speed too fast, current too low, incorrect torch positioning
515 (Fig. 11.7)	Root concavity	Root pass 'sucked back' to give a shallow groove	Current too high, root gap too wide, root face too thin
510	Burn-through	Localised loss of weld pool in root	Current too high, travel speed too slow, root face too thin, root gap too large
506 (Fig. 11.8)	Overlap (roll-over)	Weld metal that has rolled over at the edges and not fused to the parent metal. May be face or root	Weld bead too large, current too high, travel speed too slow, prevalent in horiz.–vert. welds, inadequate cleaning
201	Porosity	Gas entrapped in weld metal giving a cavity. May be localised, uniformly distributed or aligned	Dirty consumables, poorly cleaned or dirty weld preparations, contaminated shield gas, contaminated (hydrogen containing) parent metal – especially castings, oxide film on parent metal, porous gas hoses, leaks in gas delivery system, condensation, poor joint design trapping gas (see Chapter 2)
2016	Worm-hole (piping)	Elongated gas cavity formed by solidification of large weld pool	Excessive current, travel speed too slow
2024	Crater pipe	Elongated cavity in the weld finish crater	Incorrect welder technique – lack of crater fill
100	Solidification cracking	Cracks in weld produced during welding	Incorrect choice of filler metal, failure to control dilution, incorrect edge preparation, crack susceptible parent

Table 11.1 (cont.)

ISO 6520 Defect no.	Defect Name	Description	Causes
			metal, high restraint, high heat input (see Chapter 2)
104	Crater cracking	Short longitudinal or star-shaped crack in finish crater	Incorrect welder technique, lack of crater fill
100	Liquation cracking	Cracking in the HAZ or in previously deposited weld metal	Incorrect filler metal, crack sensitive parent metal, high restraint, high heat input (see Chapter 2)
303	Oxide entrapment	Oxide films trapped within the weld metal	Oxide films in or on parent metal, oxide films in or on filler metal, oxygen in shield gas, poor gas shielding, inadequate cathodic cleaning
3034	Puckering	Excessive oxide entrapment from weld pool turbulence	Poor gas cover, very high weld current
3041 (tungsten) 3042 (copper)	Tungsten or copper inclusions	Accidental contact of the electrode (TIG) or contact tip (MIG)	Poor welder technique, incorrect mechanised set-up
602	Stray arc strike	Accidental arcing outside weld prep.	Welder carelessness
602	Spatter	Droplets of weld metal expelled from weld pool	Poor welder technique, incorrect weld parameters
606	Underflushing	Thinning below design thickness	Excessive grinding



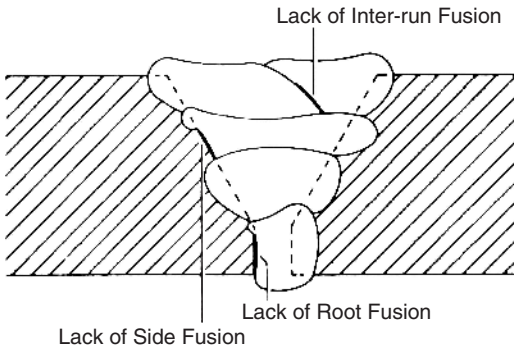

11.1 Defects 4011 lack of side wall fusion, 4012 lack of inter-run fusion, 4013 root fusion.

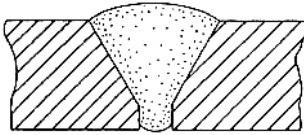

Insufficient penetration

11.2 Defect 4021.

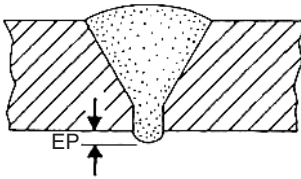

Excessive penetration (EP)

11.3 Defect 504.

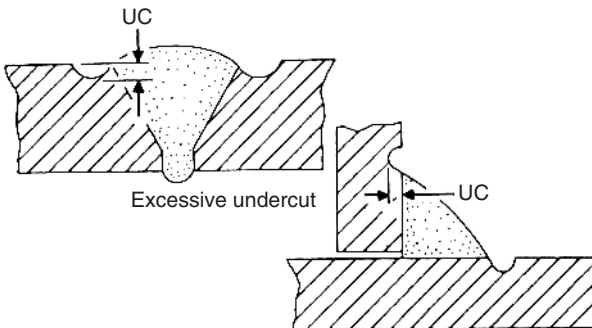

11.4 Defect 501.

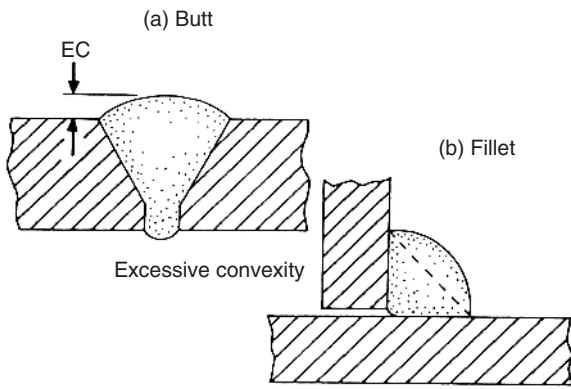

11.5 (a) Defect 502. (b) Defect 503.

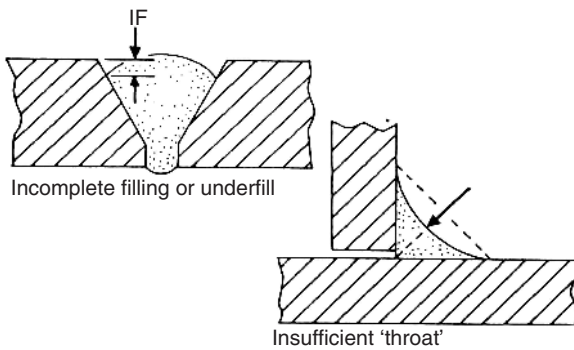

11.6 Defect 511.

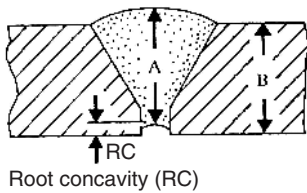

11.7 Defect 515.

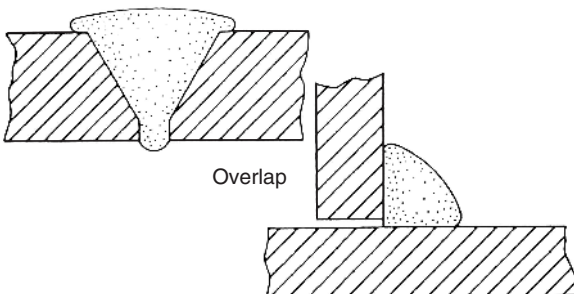

11.8 Defect 506.

static or dynamic loading, temperature and corrosive conditions and the consequences of failure.

### 11.3 Non-destructive testing methods

NDE may be used to reveal defects that would be difficult or impossible to detect by visual examination. The techniques are used during manufacture as a quality control tool to determine the quality of the work. The extent of NDE depends upon the application and the criticality of the joint and is generally specified in the relevant application standards or contract specification. It is important for NDE to be included in the planning of the fabrication process as it can require substantial time and resources. Full account of this must be taken if disruption of production and delays to the programme are to be avoided.

The requirement to perform NDE must also be taken into account during the design phase. As with welding, access for NDE must be planned into the component. The implication of this is that both welding engineers and designers must be conversant with the techniques and their limitations if the processes are to be used effectively.

#### 11.3.1 Penetrant examination

This is a technique that is capable of detecting surface breaking defects only. It relies upon a coloured or fluorescent dye, sprayed upon the surface, penetrating these defects. After cleaning the excess from the surface, the dye within the defect is drawn to the surface by spraying on a developer in the case of the colour contrast dye or by exposing the surface to ultra-violet light. The defect is revealed by the dye staining the developer or by fluorescing (Fig. 11.9).

Figure 11.10 is a photograph of a typical penetrant examination indication. The fluorescent dye gives greater sensitivity than the colour contrast dye and does not require the use of a colour contrast developer but does require the use of an ultra-violet light and preferably a darkened room. The cleaners, penetrant dyes and developers can all be obtained in aerosol cans, making the process extremely portable and ideal for site use.

The dye used as a penetrant must be capable of penetrating narrow cracks but must not be removed from more open defects during the cleaning operation carried out before the application of the developer. The dye must have a high contrast with the developer. It is important that the test piece is thoroughly pre-cleaned – any dirt, oil or water in the crack may prevent the penetrant from entering. Degreasing should be carried out by swabbing or immersing the item in one of the proprietary cleaners, acetone or methanol. Immersion in an ultrasonic cleaning bath is probably the best

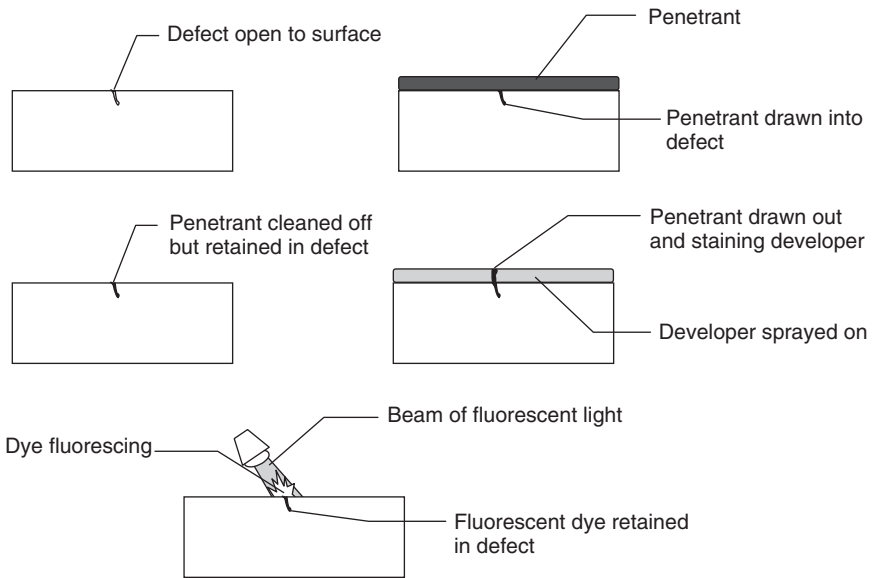

11.9 Penetrant examination principles.

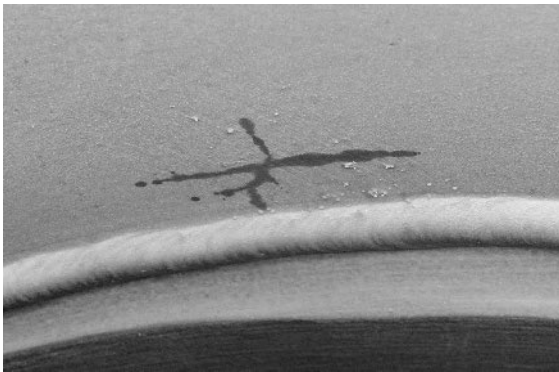

11.10 Liquid penetrant test result illustrating staining of the spray-on developer by a defect in the HAZ. Courtesy of TWI Ltd.

method. Wire brushing or grinding should not be used unless it can be followed by an acid etch as mechanical methods of cleaning can smear over defects and prevent the dye from penetrating.

Inspection in other than the flat position is difficult but penetrants have been developed with a jelly-like consistency that can be used to carry out inspections in the vertical and overhead positions. Automated methods may be used, with the components loaded into baskets and processed on a con-

veyor line. The fluorescent dyes are better in this application than colour contrast dyes because of their greater sensitivity.

Sensitivity of the process can be checked using standard test blocks. For the examination of aluminium components, these are available in 2024 alloy heat treated to give real cracks of a standard size. These blocks should be scrupulously cleaned after each check to ensure that the cracks do not become clogged with debris.

Although the technique is simple to use, interpretation of the results can be difficult, particularly if the surface is ‘naturally’ rough or if the dye is trapped in acceptable geometric features. Operatives should therefore be trained and, for many tasks, a qualification in penetrant examination is either an application standard or contract requirement. Both the British Institute of NDT (BINDT) and the American Welding Society (AWS) run accreditation schemes.

There are few health and safety risks involved in using the technique. The cleaners and some of the solvents in which the dye and developer are dissolved will cause skin irritation if used with unprotected hands, and gloves are strongly recommended. The cleaners and solvent vapours will also need to be controlled if the process is used in confined spaces. Some of these materials are also flammable, so there are fire and explosion risks.

**Advantages:**

- It can be used on both ferrous and non-ferrous metals.
- It is very portable.
- Large areas can be examined very quickly.
- It can be used on small parts with complex geometry.
- It is simple, cheap and easy to use and interpret.

**Disadvantages:**

- It will only detect defects open to the surface.
- Careful surface preparation and cleanliness are required.
- It is not possible to retest a component indefinitely.
- There may be health and safety problems with some of the chemicals.
- There are health and safety problems with fumes in confined spaces.

### 11.3.2 Eddy current examination

Eddy current examination is a process that may be used on any material that will pass an electric current. A coil carrying an alternating current is placed close to the item to be examined, inducing an eddy current in the specimen. Defects in the specimen will interrupt this eddy current flow and these perturbations can be detected by a second, search coil. The coils can

be placed either side of a thin plate-like sample or can be wound to give side-by-side coils in a single probe. These may be shaped to fit in the bore or around the outside of pipes and tubes and in these applications the process lends itself to automation. The equipment is calibrated using a defect-free specimen. The accuracy can be affected by metallurgical condition, stand-off and coil dimensions. For these reasons eddy current testing is used only rarely on welded components, although it is excellent in examining continuously welded tube from pipe mills. The process has been developed over recent years to make it more portable and simpler to use. Microprocessor-based control and recording units, improved and more tolerant probes and light-weight electronics have enabled the technique to be used on-site for the examination of structures in service, where it is an effective tool for the detection of cracking and corrosion problems. It is also possible for the depth of surface cracks to be determined. It is of limited use for interrogating welds, however, being most commonly used in the examination of continuously welded tube, and is not covered further in this chapter.

### 11.3.3 Ultrasonic examination

The ultrasonic examination of welds uses the same principles as when sonar is used for the detection of submarines. A 'sound' wave emitted from a transmitter is bounced off an object and this reflection captured by a receiver. The direction and distance of the object can be determined by measuring the elapsed time between transmission and detection of the 'echo'. In welded components this is usually done by moving a small probe, containing both transmitter and receiver, over the item to be examined and displaying the echo on an oscilloscope screen. The probe transmits a beam of ultrasound that passes through the metal and is reflected back from any defects, much like shining a torch at a mirror, in principle with the same rules applying to the reflection of the beam. This is illustrated in Fig. 11.11. Deeply buried defects such as lack of fusion, lack of penetration and cracks in addition to volumetric defects such as slag entrapment and porosity are all easily detected.

The success of the technique depends upon the use of trained, experienced operators who know precisely the characteristics of the metal being examined, the beam direction, its amplitude and frequency and the weld geometry. It is recommended that operators should be approved to one of the certification schemes such as those operated by the BINDT or the ASNT.

The frequency of the ultrasonic waves is generally in the range of 2–5 MHz, the lower frequencies being used for the examination of coarse-grained material and on rough surfaces. The higher-frequency probes are used for the detection of fine defects such as cracks, non-metallic inclusions,

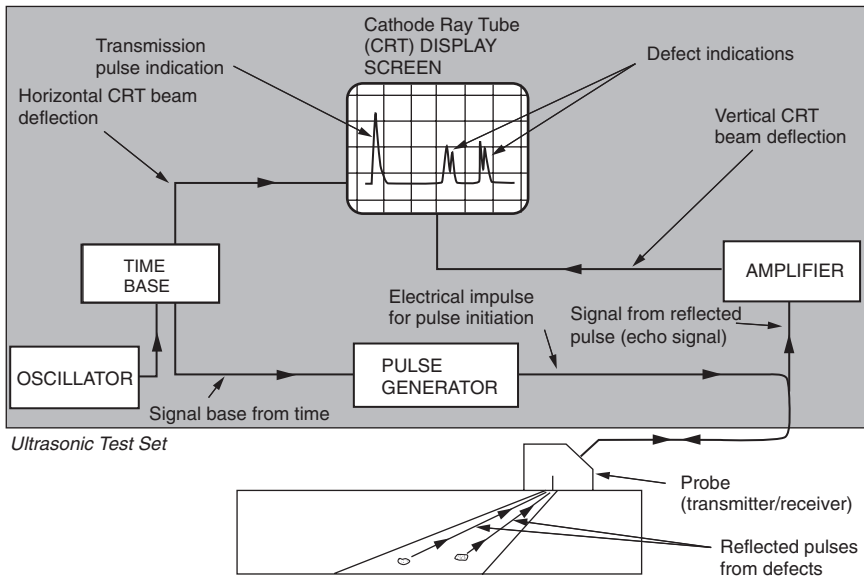

11.11 Principles of ultrasonic testing of metals. Courtesy of TWI Ltd.

lack of fusion and voids. The beams are transmitted as either compression waves or shear waves and, ideally, a defect should be oriented normal to the wave to give the maximum reflection. Projecting the beam at a glancing angle at a planar defect can result in the beam being reflected away from the receiver and lost – remember the analogy of the torch and the mirror. The probe angle should be selected to optimise the reflection of the sound beam. Probes that project the beam into the test piece at an angle normal to the plate surface are ideally suited to the detection of laminar defects, i.e. those lying parallel to the plate surface and for determining the plate thickness (Fig. 11.12).

Probes can be obtained that project the beam into the test piece at an angle, the most common being  $45^\circ$ ,  $60^\circ$  and  $70^\circ$ . The angled probes are best suited for the detection of defects at an angle to the plate surface such as lack of sidewall fusion. Here the defect is at the angle of the original weld preparation and as illustrated in Fig. 11.13 is easiest to detect by a probe of an appropriate angle. Note that the beam may be ‘skipped’ along the interior of a plate, enabling defects a long distance from the probe to be found.

Before commencing the examination some preparation work is necessary. Data on material and heat treatment, welding process and procedure and weld preparation design are necessary if accurate determinations of defect types, orientations and sizes are to be made. The normal inspection

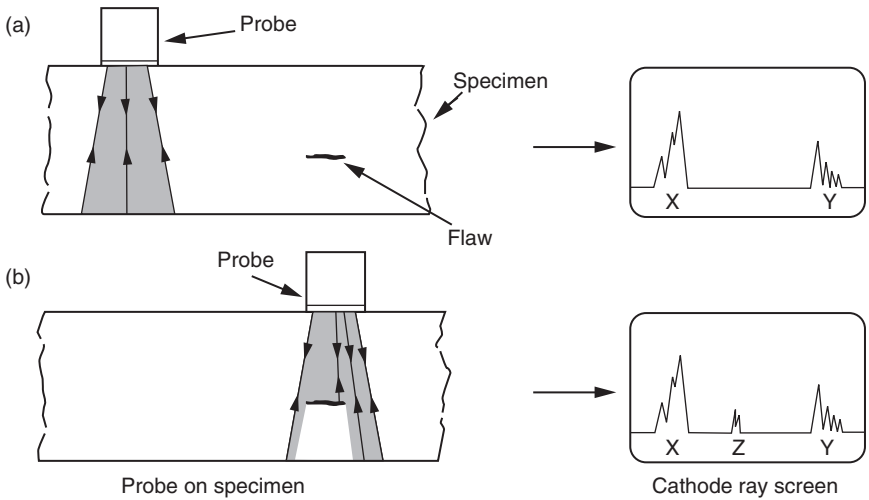

11.12 Compression wave examination. Courtesy of TWI Ltd.

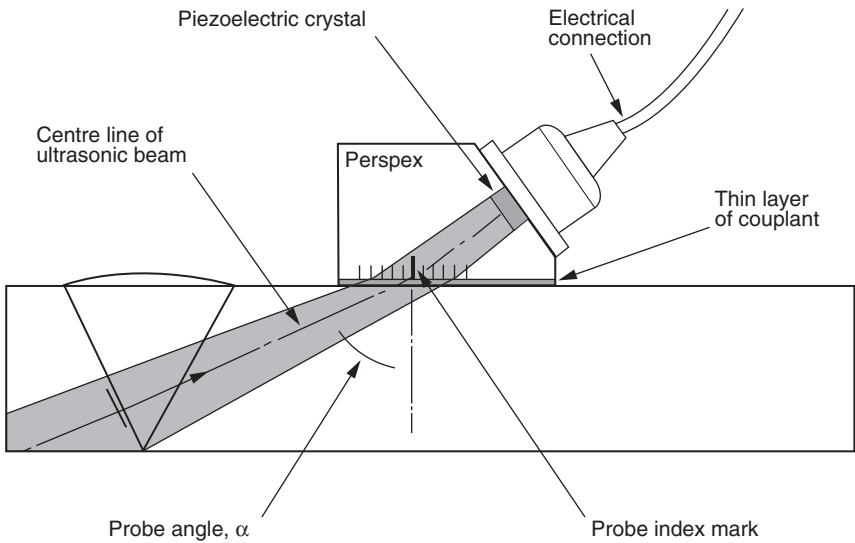

11.13 Angle probe examination of a weld. Courtesy of TWI Ltd.

method is to scan the probe on the surface of the parent metal adjacent to the weld. To do this the surface must be free of scale, spatter and roughness and the parent metal should ideally be free of laminations and excessive inclusions. A couplant, generally water, oil, grease or glycerine, is applied to form a film on the surface of the test piece. This aids the transmission of the beam into the sample.



To ensure that all of the defects in both the weld and the HAZ are detected the probe must be scanned over the full cross-section and the full length of the weld. Accurate sizing and positioning of any defects relies upon accurate marking out of the weld. Flaws that lie parallel to the beam may be missed and to ensure that this does not occur it is necessary to scan in two directions at 90° to each other. Interpretation of the reflections from regions such as root penetration beads, backing straps and fillet weld roots can be very difficult, leading to incorrect defect sizing and sentencing. For this reason the root area is frequently excluded from the area to be ultrasonically examined.

**Advantages:**

- It is very good for the detection of planar defects and cracks.
- It can easily determine defect depth.
- It is readily portable.
- Access is required to one side only.
- There are none of the health and safety problems associated with the radiographic technique.

**Disadvantages:**

- Very skilled operators are required.
- Surface breaking defects are difficult to detect.
- Accurate sizing of small (<3 mm) defects is difficult or impossible.
- The geometry of the joint can restrict the scanning pattern and prevent accurate interpretation.
- No permanent objective record is available.
- The process can be slow and laborious.

### 11.3.4 Radiographic examination

Electromagnetic radiation has properties that are useful for industrial radiography purposes. The rays travel in straight lines and cannot be deflected or reflected by mirrors or lenses; they have wavelengths that enable the radiation to penetrate many materials, including most metals. They will, however, damage living tissue and therefore present some health and safety problems.

The radiation, either X-rays from a suitable source or gamma rays from a radioactive isotope, is absorbed as it passes through the material. This absorption increases as the density of the material increases so that if a photographic film is placed on the side opposite the radiation source, any less dense areas will appear as darker areas on the film (Figs. 11.14 and 11.15), to give a shadow picture of the internal features of the test sample once the film has been processed. Thus voids, porosity, slag, cracks and defects of

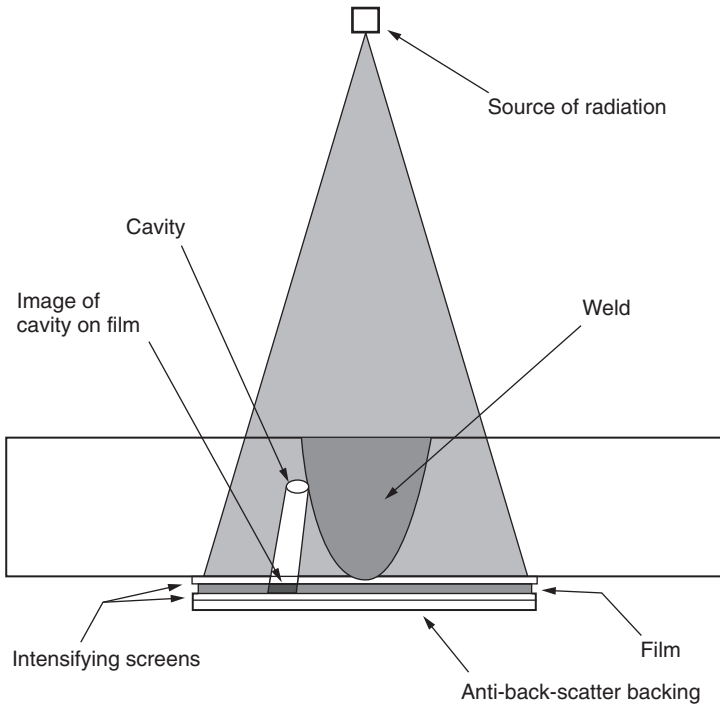

11.14 Principles of radiographic examination of a weld. Courtesy of TWI Ltd.

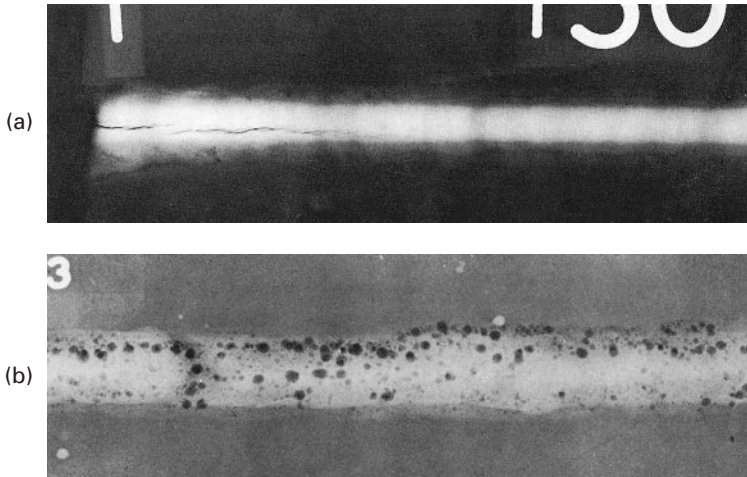

11.15 Radiograph of aluminium welds. (a) Longitudinal cracking at the weld start. Close square TIG butt weld in 7000 series alloy. (b) Gross porosity in TIG butt weld in 4000 series alloy.

geometry can all be identified, although planar defects normal to the beam may not be detected.

To radiograph a welded joint a suitable source of radiation, a film in a light-proof cassette and some method of processing the film are required. This latter generally requires a dark room where the film can be developed, fixed, washed, dried and viewed. The radiation can be produced from an X-ray tube, the energy generally being described by the voltage and current at which the tube is operated. These may vary from 20kV to 30MV and 10 to 30mA, although the normal limit for the commonly available industrial units is around 400kV. A 400kV unit is capable of penetrating up to 100mm of steel and 200mm of aluminium. Gamma radiation is produced by the decay of a naturally occurring or manufactured radioactive isotope. The isotopes decay over a period of time, a measure of the longevity of the source being the *half life*, the length of time taken for the source to decay to half of its initial intensity. The most common isotopes are cobalt-60, half life 5.3 years; caesium-137, half life 30 years; iridium-192, half life 74 days; thulium-170, half life 127 days and ytterbium-169, half life 31 days. The strength of the source is expressed as curies or becquerels. As a gamma ray source cannot be switched off the isotope is stored in a special container equipped with either a port that can be opened remotely to expose the source or from which it can be wound out when required (Fig. 11.16).

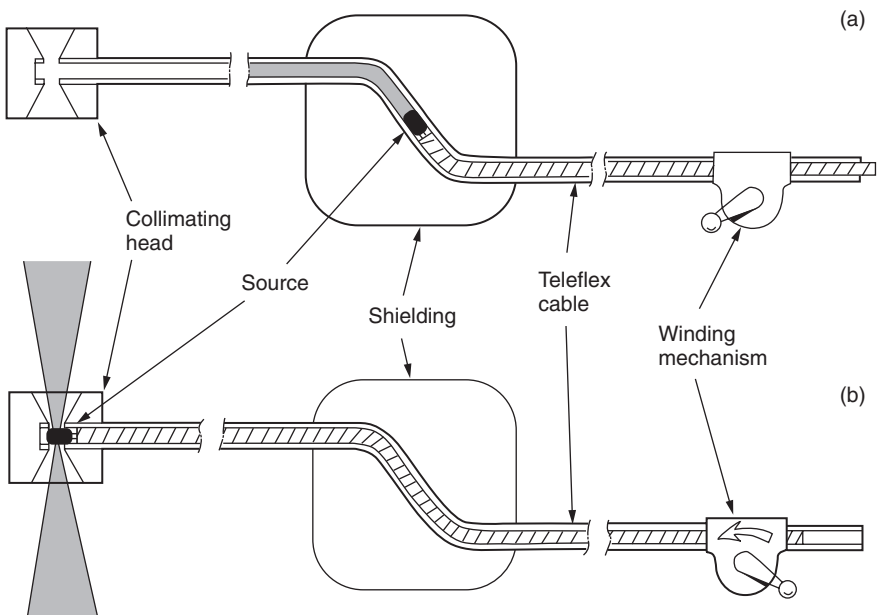

11.16 Radioactive isotope projection system. Courtesy of TWI Ltd.

Neutron and electron guns are also used to produce high-energy beams. These can be used for interrogating materials in the same way as X- and gamma radiation. This equipment is not as readily available but has its uses in industry, particularly for very thick components where long exposure times would be required using conventional lower energy sources.

The quality of the radiograph is affected by the source to film distance – the greater this is the sharper the image; the size of the radiation source – the smaller the source the sharper the image; the beam energy – the higher the energy the less sharp the image; the film grain size and quality and the correct film processing. To enable the radiographic quality to be determined an image quality indicator (IQI) is used. This comprises a number of wires of different diameters or a stepped wedge with varying diameters of holes drilled in the steps. The IQI is placed on the source side of the test piece and adjacent to or across the weld so that its image can be seen on the radiograph after processing. The diameter of the thinnest wire or the smallest diameter hole that can be seen is then expressed as a percentage of the specimen thickness – the percentage sensitivity of the radiograph. The other quality control measure is the density of the radiograph which may be measured easily with a densitometer. Ideally the density should be between 1.8 and 2.5. Radiographs produced using X-radiation are generally of better quality than those produced using gamma radiation. Variations in sample thickness will result in variations in density which may make parts of the film either too dark or insufficiently dense for accurate defect detection.

Real time radiographic equipment is now being more widely used. This uses a fluoroscopic screen and a video camera, enabling the image to be stored, retrieved, and automatically judged almost instantly. This has obvious benefits with respect to the speed of identifying and correcting welding faults.

Radiographic interpretation should be entrusted to well-trained experienced radiographers and should be performed in a darkened viewing room on a viewer designed for the task.

**Advantages:**

- A permanent record is available.
- Both buried and surface defects can be detected and the technique is particularly good for finding volumetric defects such as slag and porosity.
- The equipment is portable, particularly the gamma ray sources.
- All materials can be examined.

**Disadvantages:**

- The capital cost of equipment, which will need to include the processing and viewing facilities.

- Health and safety considerations – large areas may need to be closed off during radiography *or* enclosures must be provided in which the radiography is carried out. Radiographers must also be monitored for exposure to radiation.
- Access is required to both sides of the component, the source on one side, the film on the other.
- There are problems in detecting planar defects and fine cracks if these are normal to the beam.
- There is a limitation on the thickness that can be radiographed and defects easily detected.
- Skilled and experienced radiographers are required.
- The depth and through thickness dimension of a defect is very difficult to determine.

# Appendix A

## British and ISO standards related to welding and aluminium

---

Listed below are all of the European and ISO standards that are related to the properties, composition and product forms of aluminium and its alloys. The list also includes design codes, welding specifications, procedure and welder approval specifications, welding guides and health and safety specifications. The list is up to date at the time of writing – May 2002 – but it should not be regarded as a definitive up-to-date listing as specifications, in particular the EN and ISO standards, are being introduced on an on-going basis and the equivalent BS specifications withdrawn.

Table A.1

No.	Std source	Number	Part	Year	Title	Key: Wholly or partially replaced by <b>Withdrawn</b> Obsolescent <i>Replaces</i>
1	British	BS 499		1991	Welding terms and symbols	
2	British	BS 499	Part 1	1992	Welding brazing and thermal cutting glossary	
3	British	<b>BS 499</b>	<b>Part 2</b>	<b>1980</b>	<b>Specification for symbols for welding</b>	
4	British	BS 499	Part 2C	1992	Welding symbols	BSEN 24063, BSEN 22553
5	British	BS 499	Part 3	1992	Specification for symbols for welding	BSEN 22553
6	British	BS 638			Arc welding power sources, equipment and accessories	
7	British	BS 638	Part 4	1996	Specifications for welding cables	
8	British	BS 638	Part 5	1988	Specifications for accessories	BSEN 60974-12
9	British	BS 638	Part 7	1984	Specifications for safety requirements for installation and use	
10	British	BS 638	Part 8	1984		BSEN 50078, BSEN 60974-11
11	British	BS 638	Part 9	1990	Specifications for power sources for manual arc welding with limited power	
12	British	BS 638	Part 10	1990	Specifications for safety requirements for arc welding equipment: welding power sources	BSEN 60974-1:1990
13	British	<b>BS 679</b>			<b>Specification for filters, cover lenses and backing lenses for use during welding and similar operations</b>	BSEN 166:1996, BSEN 167:1995, BSEN 168:1995, BSEN 169:1992

Table A.1 (cont.)

No.	Std source	Number	Part	Year	Title	Key: Wholly or partially replaced by <b>Withdrawn</b> Obsolescent <i>Replaces</i>
14	British	BS 1470		1987	Specification for wrought aluminium and aluminium alloys for general engineering purposes – drawn tube	BSEN 485-1-4, BSEN 515, BSEN 573 1-4
15	British	BS 1471		1972	Specification for wrought aluminium and aluminium alloys for general engineering purposes: drawn tube	
16	British	BS 1472		1972	Specification for wrought aluminium and aluminium alloys for general engineering purposes: forging stock and forgings	ISO 209-1, ISO 209-2, BSEN 586 1&2, BSEN 604-1, BSEN 603 1&2 ISO 209-, ISO 209-2
17	British	BS 1473		1972	Specification for wrought aluminium and aluminium alloys for general engineering purposes: rivet, bolt and screw stock	
18	British	BS 1474			Specification for wrought aluminium and aluminium alloys for general engineering purposes: bars, extruded round tubes and sections	ISO 6362, ISO 209-, ISO 209-2, BSEN 755 1-6
19	British	<b>BS 1475</b>		<b>1972</b>	<b>Specification for wrought aluminium and aluminium alloys for general engineering purposes – wire</b>	BSEN 1301 1 to 3
20	British	BS 1490		1988	Specification for aluminium and aluminium alloy. Ingots and castings for general engineering purposes	ISO 3522, ISO 7722, BSEN 1676



21	British	<b>BS 2653</b>		<b>1955</b>	<b>Specification for protective clothing for welders</b>	BSEN 470-1
22	British	BS 2901			Filler rods and wires for gas-shielded arc welding	
23	British	BS 2901	Part 4	1990	Specification for aluminium and aluminium alloys and magnesium alloys	
24	British	BS 3019			TIG welding	
25	British	BS 3019	Part 1		Specification for TIG welding of aluminium, magnesium and their alloys	BSEN 1011-4
26	British	BS 3451		1981	Methods of testing fusion welds in aluminium and aluminium alloys	BSEN 895, BSEN 910, BSEN 1320, BSEN 1321
27	British	BS 3571			MIG welding	
28	British	BS 3571	Part 1	1985	Specification for MIG welding of aluminium and aluminium alloys	
29	British	BS 4300			Specification for wrought aluminium and alloys for general engineering purposes	
30	British	BS 4300	Part 1		Part 1 Longitudinally welded tube	
31	British	BS 4300	Part 4		Part 4 Solid extruded bars and sections	
32	British	BS 4300	Part 10		Part 10 Drawn tube	
33	British	BS 4300	Part 11		Part 11 Forging stock and forgings	
34	British	BS 4300	Part 12		Part 12 Bars, extruded round tube and sections	
35	British	BS 4300	Part 13		Part 13 Welding wire	
36	British	BS 4300	Part 15		Part 15 Bar, extruded round tube and sections	
37	British	BS 7570		1992	Code of practice for validation of arc welding equipment	
38	British	BS 8118			Structural use of aluminium	
39	British	BS 8118	Part 1	1991	Code of practice for design	
40	British	BS 8118	Part 2	1991	Specification for materials, workmanship and protection	

---

Table A.1 (cont.)

No.	Std source	Number	Part	Year	Title	Key: Wholly or partially replaced by <b>Withdrawn</b> Obsolescent <i>Replaces</i>
41	European	BS EN 166		1996	Personal eye-protection. Specifications	
42	European	BS EN 167		1996	Personal eye-protection. Optical test methods	
43	European	BS EN 168		1996	Personal eye-protection. Non-optical test methods	
44	European	BS EN 169		1992	Specification for filters for personal eye-protection equipment used in welding and similar operations	
45	European	BS EN 287			Approval testing of welders for fusion welding	
46	European	BS EN 287	Part 2	1992	Aluminium and aluminium alloys	
47	European	BS EN 288			Specification and approval of welding procedures for metallic materials	
48	European	BS EN 288	Part 1	1992	General rules for fusion welding	
49	European	BS EN 288	Part 2	1992	Welding procedure specification for arc welding	
50	European	BS EN 288	Part 4	1992	Welding procedure tests for the arc welding of aluminium and its alloys	
51	European	BS EN 470			Protective clothing for use in welding and allied processes	
52	European	BS EN 470	Part 1	1995	General Requirements	
53	European	BS EN 485			Aluminium and aluminium alloys. Sheet, strip and plate	
54	European	BS EN 485	Part 1		Part 1 Inspection and delivery conditions	
55	European	BS EN 485	Part 2		Part 2 Mechanical properties	
56	European	BS EN 485	Part 3		Part 3 Tolerance on shape and dimensions – hot rolled products	

57	European	BS EN 485	Part 4	Part 4 Tolerance on shape and dimensions – cold rolled products
58	European	BS EN 486		Aluminium and aluminium alloys. Extrusion ingots
59	European	BS EN 487		Aluminium and aluminium alloys. Rolling ingots
60	European	BS EN 515	1993	Aluminium and aluminium alloys. Wrought products. Temper designations
61	European	BS EN 573		Aluminium and aluminium alloys. Chemical composition and form of wrought products
62	European	BS EN 573	Part 1	Numerical designation system
63	European	BS EN 573	Part 2	Chemical symbol based designation system
64	European	BS EN 573	Part 3	Chemical composition
65	European	BS EN 573	Part 4	Forms of products
66	European	BS EN 575		Aluminium and aluminium alloys. Master alloys produced by melting
67	European	BS EN 576		Aluminium and aluminium alloys. Unalloyed aluminium alloys for remelting
68	European	BS EN 586		Aluminium and aluminium alloys. Forgings
69	European	BS EN 586	Part 1	Part 1 Inspection and delivery conditions
70	European	BS EN 586	Part 2	Part 2 Mechanical properties and additional requirements
71	European	BS EN 601		Aluminium and aluminium alloys. Chemical composition of castings in contact with food
72	European	BS EN 602		Aluminium and aluminium alloys. Wrought products. Chemical composition of semi-products in contact with food
73	European	BS EN 603		Aluminium and aluminium alloys. Wrought forging stock
74	European	BS EN 603	Part 1	Part 1 Inspection and delivery conditions
75	European	BS EN 603	Part 2	Part 2 Mechanical properties
76	European	BS EN 604		Aluminium and aluminium alloys. Cast forging stock

Table A.1 (cont.)

No.	Std source	Number	Part	Year	Title	Key: Wholly or partially replaced by <b>Withdrawn</b> Obsolescent <i>Replaces</i>
77	European	BS EN 604	Part 1		Part 1 Inspection and delivery conditions	
78	European	BS EN 604	Part 2		Part 2 Tolerances on dimensions and form	
79	European	BS EN 719		1994	Welding co-ordination. Tasks and responsibilities	
80	European	BS EN 729			Quality requirements for welding. Fusion welding of metallic materials	
81	European	BS EN 729	Part 1	1995	Guidelines for selection and use	
82	European	BS EN 729	Part 2	1995	Comprehensive quality requirements	
83	European	BS EN 729	Part 3	1995	Standard quality requirements	
84	European	BS EN 729	Part 4	1995	Elementary quality requirements	
85	European	BS EN 755			Aluminium and aluminium alloys. Extruded rod/bar, tube and profiles	
86	European	BS EN 755	Part 1	1997	Technical conditions for inspection and delivery	
87	European	BS EN 755	Part 2	1997	Mechanical properties	
88	European	BS EN 755	Part 3	1996	Round bars, tolerances on dimensions and form	
89	European	BS EN 755	Part 4	1996	Square bars, tolerances on dimensions and form	
90	European	BS EN 755	Part 5	1996	Rectangular bars, tolerances on dimensions and form	
91	European	BS EN 755	Part 6	1996	Hexagonal bars, tolerances on dimensions and form	
92	European	BS EN 895		1995	Destructive tests on welds in metallic materials. Transverse tensile test	

93	European	BS EN 910		1996	Destructive tests on welds in metallic materials. Bend tests
94	European	BS EN 1301			Aluminium and aluminium alloys. Drawn wire
95	European	BS EN 1301	Part 1	1997	Technical conditions for inspection and delivery
96	European	BS EN 1301	Part 2	1997	Mechanical properties
97	European	BS EN 1301	Part 3	1997	Tolerances on dimensions
98	European	BS EN 1320		1997	Destructive tests on welds in metallic materials. Fracture tests
99	European	BS EN 1321		1997	Destructive tests on welds in metallic materials. Macroscopic and microscopic examination of welds
100		BS EN 1418		1998	Welding personnel – Approval testing of welding operators for fusion welding and resistance weld setters for fully mechanised and automatic welding of metallic materials
101	European	BS EN 1676			Aluminium and aluminium alloys. Alloyed ingots for remelting
102	European	BS EN 1715			Aluminium and aluminium alloys. Drawing stock
103	European	BS EN 1715	Part 1		Part 1 General requirements and technical conditions for inspection and delivery
104	European	BS EN 1715	Part 2		Part 2 Specific requirements for electrical applications
105	European	BS EN 1715	Part 3		Part 3 Specific requirements for mechanical uses
106	European	BS EN 1715	Part 4		Part 4 Specific requirements for welding applications
107	European	BS EN 1780			Aluminium and aluminium alloys. Designation of unalloyed and alloyed aluminium ingots for remelting, master alloys and castings
108	European	BS EN 1011			Welding recommendations for welding of metallic materials

Table A.1 (cont.)

No.	Std source	Number	Part	Year	Title	Key: Wholly or partially replaced by <b>Withdrawn</b> Obsolescent <i>Replaces</i>
109	European	BS EN 1011	Part 1	1998	General guidance for arc welding	
110	European	BS EN 1011	Part 4		Arc welding of aluminium and aluminium alloys	
111	European	BS EN 22553		1995	Welded, brazed and soldered joints. Symbolic representations on drawings.	
112	European	<b>BS EN 24063</b>		<b>1992</b>	<b>Welded brazing, soldering and braze welding of metals. Nomenclature of process and reference numbers for symbolic representation on drawings</b>	BS EN ISO 4063
113	European	<b>BS EN 50078</b>		<b>1994</b>	<b>Torches and guns for arc welding</b>	BS EN 60947-7
114		BS EN 60974			Arc welding equipment	
115		BS EN 60974	Part 1	1998	Torches	
116	European	BS EN 60974	Part 11	1996	Electrode holders	
117	European	BS EN 60974	Part 12	1996	Coupling devices for welding cables	
118	International	BS EN ISO 4063			Welding and allied processes. Nomenclature of process and reference numbers	
119	International	ISO 209	Part 1	1989	Wrought aluminium and aluminium alloys. Chemical composition and forms of products – Part 1 Chemical composition. 1st edition	
120	International	ISO 209	Part 2	1989	Wrought aluminium and aluminium alloys. Chemical composition and forms of products – Part 2 Forms of products. 1st edition	
121	International	ISO 3522		1984	Cast aluminium alloys. Chemical composition and mechanical properties, 2nd edition	

122	International	ISO 6362	Part 1	Wrought aluminium and aluminium alloys. Extruded rods/bars, tubes and profiles – Technical conditions for inspection and delivery	<b>Supersedes ISO 5191</b>
123	International	ISO 6362	Part 2	Wrought aluminium and aluminium alloys. Extruded rods/bars, tubes and profiles – mechanical properties	
124	International	ISO 6362	Part 3	Wrought aluminium and aluminium alloys. Extruded rods/bars, tubes and profiles. Extruded rectangular bars – tolerances on dimensions and form	
125	International	ISO 6362	Part 4	Wrought aluminium and aluminium alloys extruded rods/bars, tubes and profiles. Extruded profiles – Tolerances on shape and dimensions	
126	International	ISO 6362	Part 5	Wrought aluminium and aluminium alloys extruded rods/bars, tubes and profiles. Extruded round, square and hexagonal bars – tolerances on shape and dimensions	<i>Replaces ISO 7273</i>
127	International	ISO 7722	1985	Aluminium and aluminium alloy castings produced by gravity or chill sand casting or by related processes. General conditions for inspection and delivery	

---

128	British	BS.CP 119		The structural use of aluminium	
129 144	Chemical	CS 3039 prENV 1999-2	1997	Chromated marine glue Design of aluminium structures – structures susceptible to fatigue	

---

BSI	British Standards Institution	Sales Department, 389 Chiswick High Road, London W4 4AL	www.bsi.org.uk Tel: 0208 996 7000 Fax: 0208 996 7001
-----	-------------------------------	--	--

---

# Appendix B

Physical, mechanical and chemical  
properties at 20 °C

---

Table A.2

Property	Aluminium	Iron	Nickel	Copper	Titanium
Crystal structure	FCC	BCC	FCC	FCC	HCP
Density (gm/cm <sup>3</sup> )	2.7	7.85	8.9	8.93	4.5
Melting point (°C)	660	1536	1455	1083	1670
Specific heat (J/kg K)	930	448	440	385	470
Thermal conductivity (W/m K)	235	79.6	92.1	389.4	15.5
Coeff. of thermal expansion ( $\Delta l/l$ °C)	$23.9 \times 10^{-6}$	$12 \times 10^{-6}$	$1 \times 10^{-6}$	$16.5 \times 10^{-6}$	$8.2 \times 10^{-6}$
Electrical resistivity ( $\mu\Omega$ cm)	2.65	9.7	6.8	1.67	55
Young's modulus $E$ (N/mm <sup>2</sup> )	$6.7 \times 10^4$	$21 \times 10^4$	$21 \times 10^4$	$12.4 \times 10^4$	$10.8 \times 10^4$
Ultimate tensile strength (N/mm <sup>2</sup> )	65	235	300	210	245



# Appendix C

## Principal alloy designations: cast products

Table A.3

BS EN numerical designation	BS EN chemical designation	Old BS number	ANSI designation	Temperature (°C)		
				Liquidus	Solidus	Melting range
	Al 99.5	LM0		640	658	18
AC-46100	Al Si10Cu2Fe	LM2		525	570	45
AC-45400	Al Si5Cu3	LM4	319	504	615	111
AC-51300	Al Mg5	LM5	B.535.0	580	642	62
AC-44100	Al Si12	LM6		567	579	12
AC-43100	Al Si12Mg	LM9	A360	550	575	25
	Al Mg10	LM10	520	445	597	152
	Al Cu10Si2Mg	LM12	222	525	625	100
AC-48000	Al Si11MgCu	LM13	A332	538	560	22
AC-45300	Al Si5Cu1Mg	LM16	355	537	620	83
	Al Si5	LM18	443			
AC-47000	Al Si12CuFe	LM20	413	565	575	10
AC-45000	Al Si6Cu4Zn	LM21	308	520	615	95
AC-45400	Al Si5Cu3Mn	LM22	319	525	625	100
AC-46500	Al Si8Cu3Fe	LM24	A380	520	580	60
AC-42000	Al Si7Mg	LM25	A356	550	615	65
	Al Si9Cu3Mg	LM26	F332	520	580	60
AC-46600	Al Si5Cu3	LM27		525	605	80
	Al Si19CuMgNi	LM28		520	625	105
	Al Si23CuMgNi	LM29		520	770	260
	Al Si17Cu4Mg	LM30	A390	505	650	145
AC-71000	Al Zn5Mg	LM31	712	570	615	45
	Al Cu4Ni2Mg2	L35				
	Al Si2CuFeNi	L51				
	Al Cu2Si1NiMnFe	L52				
	AlCu4Ti	L91 L92				
	AlZn5Mg	DTD5008B				

# Appendix D

## Alloy designations: wrought products

Table A.4

BS EN numerical designation	BS EN chemical designation	Old BS/DTD number	Temperature (°C)		
			Liquidus	Solidus	Melting range
	Al 99.99	1	660	660	0
AW-1080A	Al 99.8	1A			
AW-1070A	Al 99.7				
AW-1050A	Al 99.5	1B	635	659	24
AW-1200	Al 99.0	1C	645	658	13
AW-1350	Al 99.5	1E			
AW-2014	Al Cu4SiMg	H15	510	635	125
AW-2017(A)	Al Cu4SiMg(A)				
AW-2024	Al Cu4Mg1	2L97/2L98			
AW-3003	Al Mn1Cu	N3			
AW-3103	Al Mn1	N3	645	655	10
AW-3004	Al Mn1Mg1				
AW-3005	Al Mn1Mg0.5				
AW-3105	Al Mn0.5Mg0.5	N31			
AW-4006	Al Si1Fe				
AW-4007	Al Si1.5Mn				
AW-4043a	Al Si5	N21	577	630	53
AW-4047A	Al Si12	N2	577	585	8
AW-5005	Al Mg1(B)	N41			
AW-5040	Al Mg1.5Mn				
AW-5049	Al Mg2Mn0.8				
AW-5050	Al Mg1.5(C)				
AW-5251	Al Mg2	N4	625	650	25
AW-5052	Al Mg2.5				
AW-5056A	Al Mg5	N6	575	630	55
AW-5154A	Al Mg3.5(A)	N5	595	640	45
AW-5454	Al Mg3Mn	N51			
AW-5554	Al Mg3Mn	N51			
AW-5356A	Al Mg5				
AW-5556A	Al Mg5.2MnCr	N61			
AW-5754	Al Mg3				

Table A.4 (cont.)

BS EN numerical designation	BS EN chemical designation	Old BS/DTD number	Temperature (°C)		
			Liquidus	Solidus	Melting range
AW-5182	Al Mg4.5Mn0.4				
AW-5083	Al Mg4.5Mn0.7	N8			
AW-5086	Al Mg4				
AW-6061	Al Mg1SiCu	H20	575	640	45
AW-6063	Al MgSi	H9	605	655	50
AW-6082	Al SiMgMn	H30	600	650	50
AW-7005	Al Zn				
AW-7020	Al Zn4.5Mg1	H17			
AW-7021	Al Zn5.5Mg1.5				
AW-7022	Al Zn5Mg3Cu				
AW-7075	Al Zn5.5MgCu	DTD5074A			
AW-8011(A)	Al FeSi(A)				

- age hardening *see precipitation hardening*
- alloy elements 35–36
- alloying interstitial and substitutional 14
- alloy metallurgy 40–46
- heat treatable 43–46
  - non-heat treatable 40–43
- aluminium
- applications 7
  - characteristics 4, Appendix B
  - history 1
- backing bars and strips 78–80
- butt welds definitions 75–78
- cold work (strain hardening) 15–16
- defects 199–205
- hot cracking 24–31
  - oxide filming 22–24
  - porosity 18–22
  - 'suck-back' in TIG welding 111
- degreasing 66–68
- mechanical cleaning 66
  - chemical cleaning (pickling) 67
- design
- backing bars and strips 78–80
  - edge preparations (joint design) 72–78
  - edge preparations (joint design) for MIG 136–139
  - edge preparations (joint design) for TIG 98–99
  - effect of position 72
  - for access 70–71
- designations 36–40
- alloy composition identification 36–38
  - temper designations 38–40
- distortion 84–89
- electron beam welding
- capabilities 157, 160
  - process principles 155–157
- fatigue 89–96
- joint classification 92–94
- filler metals
- effect on hot cracking 29–31
  - selection 46–50
- fillet weld definitions 74, 75
- friction welding
- friction stir welding 161–165
    - capabilities 163, 164, 165
    - mechanical properties 165
- process principles 160–161
- rotary motion 161
- gamma radiography 213
- GMAW *see* MIG
- grain size 12–13
- effect on hot cracking 30
- GTAW *see* TIG
- handling of parent metals 51
- laser cutting 58–63
- health and safety 60–63
  - parameters 61
  - principles 58–60
- laser welding
- arc augmented 154–155
  - CO<sub>2</sub> laser welding 152–153
  - defects 154
  - Nd-YAG (solid state) welding 153–154
  - process principles 150–152
- liquation cracking *see* hot cracking
- mechanical cutting 64–66
- MIG welding
- arc starting 135
  - contact tip 129–130
  - electro-gas welding 143–144
  - filler wire 133–134
  - fine wire 124
  - mechanised and robotic welding 141–143
  - parameters (argon shielding) 136–137
  - parameters (helium shielding) 138
  - power sources 119–121
  - process principles 116–118

- pulsed MIG 121–124
  - shielding gases 130–133
  - spot welding 144–146
  - terminating the weld 140–141
  - torches 125–126
  - torch positioning 138–140
  - twin wire 124–125
  - wire feeders 127–128
- non-destructive testing 205–215
    - eddy current 207–208
    - penetrant 205–207
    - radiography 211–215
    - ultrasonic 208–211
  - penetrant examination 205–207
  - plasma arc cutting 52–58
    - health and safety 56–58
    - parameters 55
    - principles 52–54
  - plasma arc welding
    - parameters 149
    - plasma MIG 150
    - process principles 147–149
    - variable polarity 149
  - porosity 18–22
    - in autogenous welds 18
    - in parent metal 22
    - effect of cleanliness 21
      - composition 20
      - hose type 20
      - process 20
    - gas dew point 20
    - ISO classification 200
  - precipitation (age) hardening 16–17
  - resistance welding
    - flash butt welding 176–180
    - power sources 167–169
    - seam welding 175–176
    - spot welding 171–175
    - surface condition 169–171
  - solidification cracking *see hot cracking*
  - solid solution strengthening *see alloying*
  - storage of parent metals 52
  - strengthening mechanisms 10–18
  - strength loss 31–34
    - in HAZ 32–34
    - in weld metal 31–32
  - TIG welding
    - effects of HF 100
    - mechanised/ automated welding 114–115
    - parameters (argon shielding) 104
    - parameters (helium shielding) 113
    - process principles 97–101
    - shielding gas 102–106
    - spot and plug welding 115
    - torches and cables 106–107
    - torch manipulation 110–112
    - tungsten electrodes 108–109
  - ultrasonic examination 208–211
  - water jet cutting 63–64
  - weldability 18–31
    - hot cracking 24–31
    - oxide film 22–24
    - porosity 18–22
  - welder approval
    - ASME IX 193, 196, 197
    - BS EN 287 Pt 2 191–193
    - BS EN 1418 197–198
  - welding procedure 181–182, 183
  - welding procedure approval
    - ASME IX 188–190
    - BS EN 288 Pt 4 182–188
      - alloy grouping 184
      - range of approval 187–188
      - test regime 185–187
  - x-radiography 213

In compiling this book the author has drawn freely on a large number of textbooks and published papers, none of which are referenced in the text. Listed below are some of the sources of information that have been used and other useful references containing more information than it has been possible to include in this practical guide to welding. Some of these references include specific information on the particular topic, others are included for those who wish to gain a more general understanding of the principles of metallurgy, the uses of aluminium and the welding processes covered in the main text.

It has been attempted to list the books and papers under the relevant chapter numbers when they are specific to the topic, for example most of the books referenced under Chapter 2 are texts on general metallurgy, Chapter 6 contains a list of references specific to TIG welding. This has not always been possible, hence the inclusion of General textbooks on welding which contains a listing of books that cover more than one process. It may surprise some readers to see that specifications have been referenced as useful sources of information. As mentioned elsewhere, specifications are documents that have been written by experts in their field and generally contain recommendations and requirements that are a summary of best practice. The shop floor engineer ignores these recommendations at his or her peril!

Included at the end of this listing are the web sites and/or addresses of a number of organisations that can provide many of the books referenced.

## **Chapter 1**

*Aluminium and its Applications*, M. Conseva et al., Edimet Spa. ISBN 88-86259-01-8.

*American Society for Materials Handbook Vol. 20 – Materials Selection and Design*, A.S.M. ISBN 0-87170-386-6.

*Science and Use of Engineering Materials*, E. Crane et al., Butterworths Ltd. ISBN 0-408-10859-2.

## **Chapter 2**

*An Introduction to Metallurgy*, A.H. Cottrell, Edward Arnold Ltd. ISBN 7131-2044-4.

*Elements of Materials Science and Engineering*, L.H. Van Vlack, Addison-Wesley Pub. Co. ISBN 0-201-52822-3.

- Mechanical Metallurgy*, G.E. Dieter, McGraw-Hill Book Co. ISBN 0-07-100406-8.  
*Metallurgy for the Non-Metallurgist*, Author and publisher American Society of Metals. ISBN 0-87170-652-0.  
*Metallurgy of Welding*, J.F. Lancaster, Woodhead Publishing Limited, ISBN 1-85573-428-1.  
*Modern Physical Metallurgy*, R.E. Smallman, Butterworth and Co.  
*Welding Metallurgy*, Sindo Kou, John Wiley and Sons. ISBN 0-471-84090-4.

### Chapter 3

- Aluminium and Its Alloys*, F. King, Ellis Horwood Ltd. ISBN 0-7458-0013-0.  
*Corrosion of Aluminium and Aluminium Alloys*, Author and publisher American Society of Metals. ISBN 0-87170-629-6.  
*Introduction to Aluminium Alloys and Tempers*, Author and publisher American Society of Metals. ISBN 0-87170-689-X.  
*Light Alloys – Metallurgy of the Light Metals*, I. Polmear, Edward Arnold Ltd. ISBN 0-7131-2819-4.  
*Properties of Aluminium Alloys – Tensile, Creep and Fatigue Data at High and Low Temperatures*, J.G. Kaufman, Aluminium Association. ISBN 0-87170-632-6.  
*Weldability of Al-Zn-Mg Alloys*, Tao Ma, Delft University of Technology. ISBN 90-9011244-8.

### Chapter 4

- Recommended Practices for Plasma Arc Cutting*, Author and publisher American Welding Society. ISBN 0-87171-219-9.

### Chapter 5

- Fatigue Design of Welded Joints and Components (Recommendations of IIW Working Group XIII–XV)*, A. Hobbacher et al., Woodhead Publishing Limited. ISBN 1-85573-315-3.  
*Fatigue Strength of Welded Structures*, S.J. Maddox, Abington Publishing. ISBN 1-85573-013-8.  
*Welded Design – Theory and Practice*, J. Hicks, Abington Publishing. ISBN 1-85573-537-7.

### General textbooks on welding (includes both TIG and MIG welding)

- Advanced Welding Systems – Vol. 1 Fundamentals of Fusion Welding Technology*, Jean Cornu, IFS (Publications) ISBN 0-948507-69-1.  
 ANSI/AWS D8.14M Specification for Automotive and Light Truck Components Weld Quality – Aluminium Arc Welding, Author and Publisher American Welding Society. ISBN 0-87171-591-0.  
*Arc Welding Automation*, H.B. Cary, Marcel Decker Inc. ISBN 0-8247-9645-4.  
*ASM Handbook Vol. 6. Welding, Brazing and Soldering*, Author and publisher American Society of Materials. ISBN 0-87170-382-3.  
 AWS D 3.7. Guide for Aluminium Hull Welding. Author and publisher American Welding Society. ISBN 0-67171-320-9.  
 AWS D 10.7. Aluminium and Aluminium Alloy Pipe. Recommended Practices for Gas Shielded Arc Welding. Author and publisher American Welding Society. ISBN 0-87171-260-1.

- Health and Safety in Welding and Allied Processes*, 5th edition, J. Blunt and N. Balchin, Woodhead Publishing Limited. ISBN 1-85573-538-5.
- Joints in Aluminium – INALCO '98*. Conference Proceedings edited by M.H. Ogle et al., Woodhead Publishing Limited. ISBN 1-85573-417-6.
- Process Pipe and Tube Welding*, ed. by W. Lucas, Abington Publishing. ISBN 1-85573-012-X.
- The Science and Practice of Welding*, 2 volumes. A.C. Davies, Cambridge University Press. ISBN 0-521-43565-X and 0-521-43566-8.
- Welding and Cutting*, P. Houldcroft, Woodhead Publishing Limited. ISBN 1-85573-578-4.
- Welding Handbook*, Vols. 1 and 2. Author and publisher American Welding Society. ISBN 0-87171-281-4 and 0-87171-354-3.
- Welding Kaiser Aluminium*, Author and publisher Kaiser Aluminium and Chemical Sales. ISBN No.

### Chapter 6

- Advanced Welding Systems – Vol. 3. TIG and Related Processes*, Jean Cornu, IFS (Publications). ISBN 0-948507-71-3.
- AWS B2.1.015. GTAW of Aluminium M-22 or P22. 10 to 18 gauge as welded with or without backing. Author and publisher American Welding Society. ISBN 0-87171-369-1.
- BS 3019 TIG Welding Part 1 Specification for TIG Welding of Aluminium and Magnesium Alloys. Author and publisher British Standards Institution. ISBN 0-580-14124-1.
- Practical TIG (GTA) Welding*, P.W. Muncaster, Abington Publishing. ISBN 1-85573-020-0.
- TIG and Plasma Welding*, W. Lucas, Abington Publishing. ISBN 1-85573-005-7.

### Chapter 7

- Advanced Welding Systems – Vol. 2. Consumable Electrode Processes*, Jean Cornu, IFS (Publications) ISBN 0-948507-70-5.
- BS 3571 MIG Welding. Part 1 Specification for MIG Welding of Aluminium and Aluminium Alloys. Author and publisher British Standards Institution. ISBN 0-580-14260-4.

### Chapter 8

- AWS C 6.1 Recommended Practices for Friction Welding. Author and publisher American Welding Society. ISBN 0-87171-309-8.
- ANSI/AWS C 7.1 Recommended Practices for Electron Beam Welding. Author and publisher American Welding Society. ISBN 0-87171-580-5.
- ANSI/AWS C 7.2 Recommended Practice for Laser Beam Welding, Cutting and Drilling. American Society of Welding. ISBN 0-87171-562-7.
- Electron Beam Welding*, H. Schultz, Woodhead Publishing Limited. ISBN 1-85573-050-2.
- Europe Follows Japan into Friction Stir Welding*, J. Davenport et al., TWI Ltd.
- Industrialisation of Friction Stir Welding for Aerospace Structures*, S.W. Kallee et al., TWI Ltd.



*Laser Welding*, P.A. Hilton et al., Woodhead Publishing Limited. ISBN 1-85573-518-0.

*Laser Welding – A Practical Guide*, C.T. Dawes, Woodhead Publishing Limited. ISBN 1-85573-034-0.

### **Chapter 9**

AWS C 1.1M Recommended Practices for Resistance Welding. Author and publisher American Welding Society. ISBN 0-87171-601-0.

### **Chapter 10**

*Guidelines for Quality Assurance in Welding Technology*, Author and publisher International Institute of Welding. ISBN 0-85300-229-0.

*Quality Assurance of Welded Construction*, N.T. Burgess et al., Elsevier Science Publishers Ltd. ISBN 1-85166-274-X.

### **Chapter 11**

ANSI/AWS B1.11 Guide for the Visual Examination of Welds. Author and publisher American Welding Society. ISBN 0-87171-625-9.

ANSI/AWS B1.10 Guide for the Non-Destructive Examination of Welds. Author and publisher American Welding Society. ISBN 0-87171-259-8.

ASM Handbook Vol.8. Mechanical Testing and Evaluation. Author and publisher American Society for Materials. ISBN 0-87170-389-0.

*Introduction to the Non-Destructive Testing of Welded Joints*, R. Halmshaw, Abington Publishing. ISBN 1-85573-314-5.

*Welding Inspection Handbook*, Author and publisher American Welding Society. ISBN 0-87171-560-0.

### **Useful contact names and addresses**

The Aluminium Association, 900 19<sup>th</sup> Street NW, Washington, DC 20006, U.S.A. [www.aluminium.org](http://www.aluminium.org)

Aluminium Federation, Broadway House, Calthorpe Road, Five Ways, Birmingham, West Midlands, B15 1TN, United Kingdom. Tel +44(0)121 4561103. [www.amtri.demon.co.uk](http://www.amtri.demon.co.uk)

American Society for Materials, 9639 Kinsman Road, Materials Park, Ohio, OH 44073-0002, U.S.A. [www.asm-intl.org](http://www.asm-intl.org)

American Society of Mechanical Engineers, Three Park Avenue, New York, NY 10016-5990, U.S.A. [www.asme.org](http://www.asme.org)

American Welding Society, 550 N.W. LeJeune Road, Miami, Florida, 33126, U.S.A. [www.aws.org](http://www.aws.org)

British Institute of Non-Destructive Testing, 1 Spencer Parade, Northampton, NN1 5AA United Kingdom. Tel +44(0)1604 630124. [www.powertech.co.uk/bindt](http://www.powertech.co.uk/bindt)

British Standards Institution, 389, Chiswick High Road, London, W4 4AL. United Kingdom. Tel +44(0)20 8996 9001. [www.bsi-global.com](http://www.bsi-global.com)

Institute of Materials, 1 Carlton House Terrace, London, SW1Y 5DB, United Kingdom. Tel. +44(0)20 7451 7300. [www.materials.org.uk](http://www.materials.org.uk)

TWI Ltd, Granta Park, Abington, Cambridge, CB1 6AL, United Kingdom. Tel +44(0)1223 891162. [www.twi.co.uk](http://www.twi.co.uk)  
Woodhead Publishing Limited (includes Abington Publishing), Abington Hall, Abington, Cambridge, CB1 6AL, United Kingdom. Tel +44(0)1223 891358. [www.woodhead-publishing.com](http://www.woodhead-publishing.com)