



**This document is brought to you by courtesy of
the National Cycle Archive
In partnership with the
Veteran-Cycle Club**

Please acknowledge the source if you refer to this material.

Find out more about the National Cycle Archive [here](#)



Cheaper cycling begins at CURRYS!



SAYS EAMONN ANDREWS

The New Elizabethan Exclusive to Currys!

Latest 'new look' styling. All-rounder comfort handlebars. Combined 3-speed and Dynohub-lighting. Finished Flamboyant Royal Carmine. Gent's or Lady's.

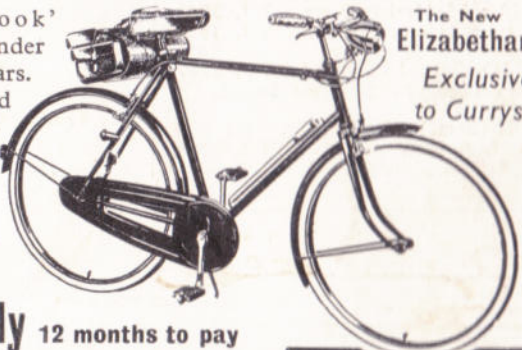

19½ GNS

7'6 weekly 12 months to pay

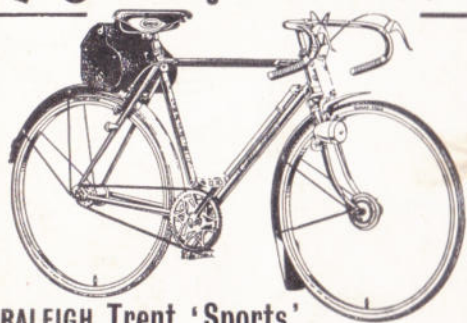

RALEIGH Trent 'Sports'

Raleigh quality and equipment at rock bottom price! The perfect 'Sports' for the younger set. Choice of colours. Sturmey-Archer 3-speed 45/10d extra. Dynohub-lighting 56/4d extra.

4'6 weekly

18 months to pay

£16. 14. 2

ANY BIKE YOU LIKE FOR

£1

DEPOSIT IMMEDIATE DELIVERY 9 months to pay

Plus all the latest models by RALEIGH, TRIUMPH, PHILLIPS, etc.

★ ASK FOR FREE COPY OF LATEST CYCLE FOLDER

Currys LTD.

29/W/756

EVERYTHING FOR THE CYCLIST!



Currys LTD.

CYCLE ACCESSORY CATALOGUE

1956

AT YOUR CYCLING SERVICE

Every cyclist looks forward to receiving a copy of Currys' annual Cycle Accessory Catalogue. It provides in handy form a complete reference to a full range of cycle accessories of the very finest quality at the keenest possible prices.

Cyclists are never far from a branch of Currys. There are more than 265 throughout Great Britain and every one of them is at YOUR cycling service, not only to supply the superior value merchandise shown in this catalogue, but also to advise you on all your cycling problems.

Whether you cycle regularly for health or pleasure, whether you are a keen clubman, or just a work-a-day cyclist of sheer necessity — you will always find a courteous welcome at Currys.

So make a point of keeping this copy of Currys' catalogue in the pocket of your cycling jacket or touring bag.

It is YOUR guide to better cycling service . . .

★ POSTAL SERVICE

All merchandise shown in this catalogue may be purchased through Currys' postal service. Just send a postal or money order to the value of the goods required, (plus 1/- in the pound for postage) to :—

Currys (Ref. E.S.),
Mail Order Service,
Whitfield Street,
Newark, Notts.

*Prices were correct
at time of publication
but are liable to
change from time
to time.*

Please give full details of article(s) required and make sure that correct size(s), where applicable, are clearly stated.

**265 BRANCHES
THROUGHOUT
GREAT BRITAIN**

Full list of addresses of all Currys' branches appears at the end of this catalogue.



Currys
LTD.

Head Office : 77 Uxbridge Road, Ealing, W.5

INDEX

For **SPEEDY REFERENCE** — All accessories listed in this catalogue appear in alphabetical order as follows :—

Description	Page	Description	Page
Auxiliary Seats	5	Dynamo Head Lamps	15
Baskets	1	Dynamo Rear Lamps	15
Batteries	20 & 21	Enamel, Synthetic	7
Battery Lamps, Front	16 & 17	Enamel, Cellulose	7
Battery Lamps, Rear	16 & 17	Feeding Bottles	8
Battery Lamp Sets	16	Feeding Bottle Carriers	8
Bells	2	Feeler Gauges	8
Bottom Bracket Fittings for cotterless brackets	3	Forks	8
Brakes, Caliper, complete	3	Free-Wheels	8
Brake Blocks	3 & 4	French Chalk	31
Brake Blocks & Shoes	3 & 4	Gloves	39
Brake Cables	3 & 4	Goggles	38
Brushes, Enamel	7	Handlebar Bends	9
Bulbs	22	Handlebar & Brake Sets	9
Cable Clips	4	Handlebar Expander Bolts	9
Capes	39	Handlebar Grips	10
Carriers — Luggage	5	Handlebar Stems	9
Chains	4	Handlebar End Stops	9
Chain Adjusters	4	Handlebar Tape	11
Chain Covers	4	Hand Soap	11
Chain Links & Parts	4	Helmets, M/Cycle	38
Chain Wheel Sets & Cranks	6	Holt's Motoring Products	14
Child Carriers	5	Horns, Bulb Type	11
Cleaners	28	Horns, Electric	11
Control Cables, 3 speed	13	Hubs	12
Cotter Pins & Nuts	6	Hub Cones	12
Cyclometers	6	Hub Spindles	12
Dress Guards	38 & 39	Hub Wing Nuts	12
Dynamo Lighting Sets	15		
Dyno-hub Lighting Sets	12		

INDEX — continued

Description	Page
Inner Tubes	37
Insulating Tape	14
Lamp Brackets	17
Learner Plates	23
Leggings	39
Licence Holders	17
Locks, Combination or Padlock	18
Lock Chains	18
Lubricating Oil	26
Luggage Carriers	5
Mascots	23
Mirrors, Cycle & M/Cycle	23
Mud Flaps	24 & 25
Mudguards	24 & 25
Mudguard Bridges	24 & 25
Nipple Keys	33
Oilcans	26
Patches, Rubber	30 & 31
Patch Strip	30 & 31
Paint Thinners	7
Paint Undercoat	7
Pannier Bag Sets	34 & 35
Pedals	26 & 27
Pedal Rubbers	27
Pedal Spares	26 & 27
Pennants	28
Petroleum Jelly	28
Polishes	28
Pressure Gauges	29
Prop Stands	34
Pumps	29
Pump Clips	29
Pump Connections	29

Description	Page
Reflectors, Cycle & Car	30
Repair Outfits	30 & 31
Rims	40
Rim Nuts	37
Rim Tapes	40
Rubber Solution	31
Saddles	32
Saddle Covers	32
Saddle Springs	32
Safety Signals, Cycle	33
Sealing Compound, 'Bostik'	33
Seat Pillars	32
Sou' Westers	39
Spanners	33
Speedometers	6
Sponges	32
Sprockets	6
Straps	1
Tennis Racquet Clips	34
Toe Clips	34
Toe Straps	34
Tool Bags	35
Torches	19
Touring Bags	34 & 35
Touring Bag Supports	35
Trouser Clips	34
Tyres	36
Tyre Levers	36 & 37
Valves, Dunlop 'Easy Pump'	37
Valve Parts	37
Valve Rubber	37
Wheels	40
Wing Nuts	12

See **CURRYS** for
the best values — in
CYCLES and
ACCESSORIES!



says
EAMONN ANDREWS

"There's not only the most complete range of accessories — as you can see from this catalogue — at Currys; they also have the finest show of cycles in town".

BASKETS — CYCLE (Including Straps)

C009 Basket, medium size, half-round, varnished willow 13" x 8" x 8" 11/3
C011 Basket, large size, half-round, varnished willow 13" x 9" x 10" 13/6

C016 Tricycle Basket, with coloured band, 8" x 5½" x 5½" 5/3
C008 Juvenile Basket, willow, 8½" x 6" x 5" 6/6

BASKET STRAPS (leather)

C111 6" x " 3d.
C082 10" x " 4d.
C110 18" x " 9d.
C091 24" x " 11d.
C093 36" x " 1/3

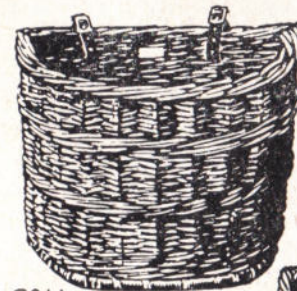

C011

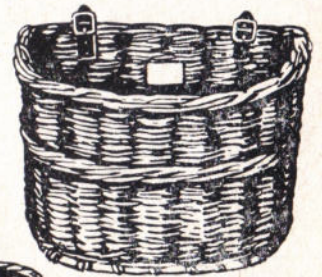

C009



C008



C016

BELLS (Revolving, Rotary & Challis) at **Currys**

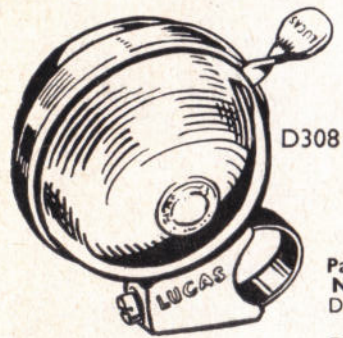

D308

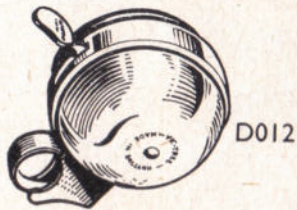

D012

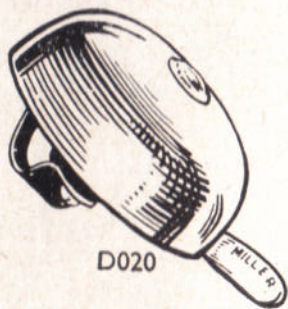

D020

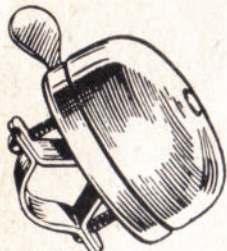

D310

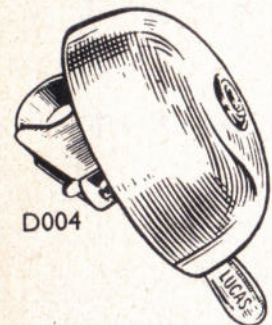

D004



D024

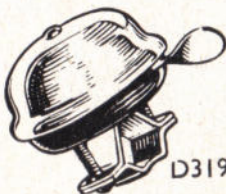

D319

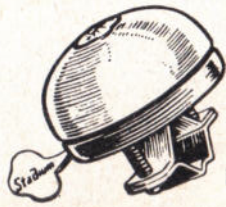

D320



D013



D019



D021

Part No.	BELLS	
D024	LUCAS No. 3. Chrome, Rotary, 2 3/16" Dome	4/3
D004	LUCAS No. 50. The original Challis 3" Lucas Bell-metal Dome in Chromium-plated finish	6/6
D308	LUCAS No. 32. The rotating bell with the pleasant but persistent peal. 2 1/2" Chrome Domes	10/6
D316	LUCAS "Comet" ...	6/6
D012	CLARITONE Revolving Bell, with 2 1/2" Chrome Domes	6/6
D310	Special Value. Standard Rotary action. 2 1/2" dome, chrome	2/6
D319	EXCEPTIONAL VALUE in JUVENILE Rotary Bells. Chromium Plated, 1 1/2" dome. 3/4" or 1/2" Handle-bar Clip	2/3
D320	Juvenile Rotary Bell with 2" dome. In brilliant lacquer finish. Green, Red or Blue	2/-
D021	MILLER No. 420. Rotary Bell, with 2 3/16" Dome Chromium Plated	3/3
D019	MILLER No. 520. Rotary Bell, with 2 3/16" Dome	3/9
D020	MILLER No. 720. Large Dome Challis Bell giving resounding ring. Chrome Plated	4/6
D013	Really wonderful value in Standard Rotary Bells. 2 1/2". Nickel Plated dome	1/6
D010/1	VICTREE "Spring Ring," alloy, 1 1/2" Dome, 3/4" or 1/2" clip	2/3

Currys for Bottom Bracket Fittings and Brakes

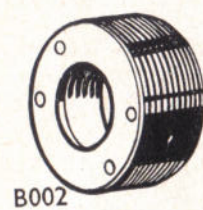

B002

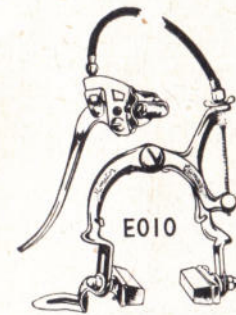

E010



E038

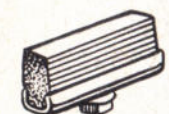

E125

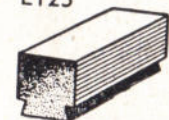

E062

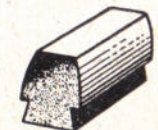

E063

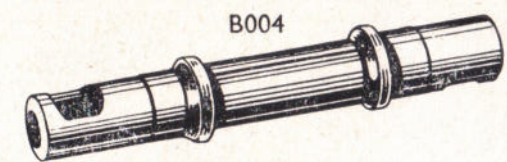

B004

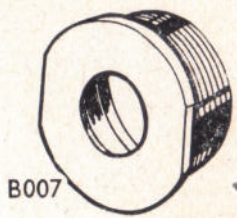

B007

BOTTOM BRACKET FITTINGS (For cotterless brackets)

Part No.	Description	Price
B002	BAYLISS WILEY, left hand B.B. Cup, No. 2, deep, peg-hole pattern, right-hand thread	1/-
B007	BAYLISS WILEY, right hand B.B. Cup. Flanged milled pattern, No. 8, left-hand thread	1/2
B003	BAYLISS WILEY, B.B. Lock Ring No. 9	7d.
B004	BAYLISS WILEY, B.B. Axle, No. 14. G.C.C. or No. 2C. G.C.C. 1/2" longer than No. 14 on chain side	2/7 1/2
B005	BAYLISS WILEY, No. 15. Non-G.C.C.	2/7 1/2

BRAKES (Caliper)

E016	CURRY SPECIAL. Side-pull action, chrome with silver cables. Front or Rear, ladies or gent's	8/6
E010	MONITOR "Climax" "Sheerline" front, chrome, side-pull	10/3
	Ditto Rear. Ladies or Gent's	10/6
E521	PHILLIPS No. 400 "Vox Populi". Side-pull Front, Chrome	10/-
	Ditto Rear. Ladies or Gent's No. 401 and 402	10/6

BRAKE CABLES (complete) Black or Silver Finish

E030	Centre-pull, Front	2/-
E032	Centre-pull, Rear, Gent's	2/6
E031	Centre-pull, Rear, Ladies	2/9
E037	RALEIGH, Side-pull, Front	2/4
E036	RALEIGH, Side-pull, Rear, Gent's	3/-
E038	RALEIGH, Side-pull, Rear, Ladies	3/6

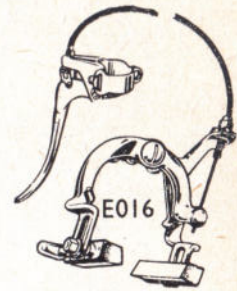

E016

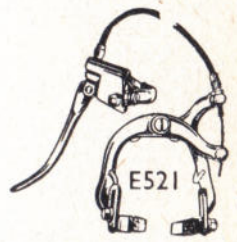

E521

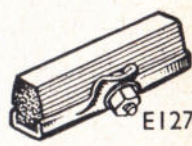

E127

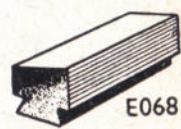

E068

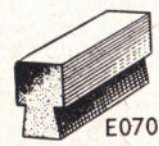

E070



E090



E065

CHAINS (Links, Parts and Covers) at **Currys**

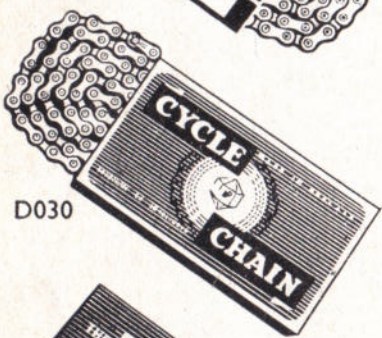
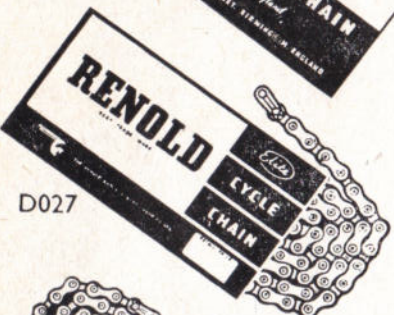
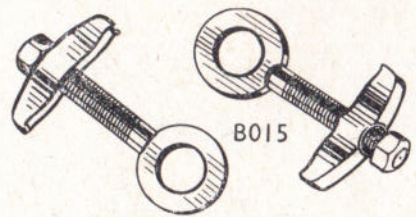

BRAKE CABLES (continued)

E050	MONITOR	Pattern, Front	...	1/6
E055	MONITOR	Pattern, Rear, Gent's	...	2/-
E054	MONITOR	Pattern, Rear, Ladies	...	2/6
E094	PHILLIPS	Pattern, for "Vox Populi", Front	...	1/6
E095	PHILLIPS	Pattern, for "Vox Populi", Rear, Gent's	...	2/-
E096	PHILLIPS	Pattern, for "Vox Populi", Rear, Ladies	...	2/6

BRAKE BLOCKS

E068	FERODO	No. 95a. Resilion Model "A"	...	Per Pair	10d.
	FERODO.	All other popular patterns as illustrated	...	Per Pair	8d.

BRAKE BLOCKS and SHOES

E120/1	PHILLIPS	"Philco" Front or Rear	...	Per Pair	1/-
E125/8	"CATOS"	Roadster or Polished Alloy	...	Per Pair	1/-
E127/9	Standard.	Roadster or Caliper, cadmium plated	...	Per Pair	9d.
E122	MONITOR	Sheerline, Front	...	Per Pair	1/10 1/2
E124	MONITOR	Sheerline, Rear	...	Per Pair	1/5

CHAINS in Standard Lengths

D027	RENOLD.	"Elite" 1/2" x 1/8"	...	9/4
D025	PERRY.	1/2" x 1/8"	...	7/6
D026	PERRY.	1/2" x 3/16"	...	11/3
D028	COVENTRY.	1/2" x 1/8"	...	7/6
D030	"M.P."	1/2" x 1/8". British made	...	5/11

CHAIN LINKS and PARTS
For Perry and Coventry Chains

D040	PERRY	Spring Link	...	5d.
D041	PERRY	Nut and Bolt	...	1d.
D043	PERRY	No. 10 Double Cranked Link	...	5 1/2d.
D044	RENOLD	Spring Link	...	4 1/2d.
B015	CHAIN ADJUSTERS	...	Per Pair	4 1/2d.

CHAIN COVERS

B025	MIDLAND.	Half Chain Cover, Hockey-Stick pattern	...	3/4
E172	CABLE CLIPS.	All Rubber	...	3d.

Currys for Rear Carriers and Auxiliary Seats

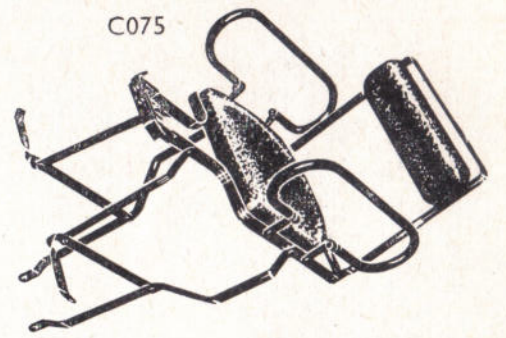
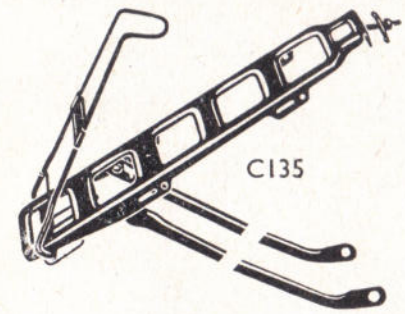

REAR CARRIERS, CHILD CARRIERS and AUXILIARY SEATS

Whether you carry parcels or an extra passenger, it's safer, and in the latter case, legally necessary to use an efficient carrier or auxiliary seat.

Part No. CARRIERS

C026	ASHBY	No. 6B/CBF, pressed steel, stay fitting for Caliper brakes. 26" Wheel. Complete with straps	...	7/7
C079	MIDLAND	No. 4614, semi-tubular, stay fitting with spring parcel clip	...	7/-
C135	BROOKS	No. 60, tubular, spindle fitting for 26" or 28" wheel, with spring parcel clip	...	7/6
C134	MIDLAND	No. 4567, semi-tubular, stay fitting	...	5/6

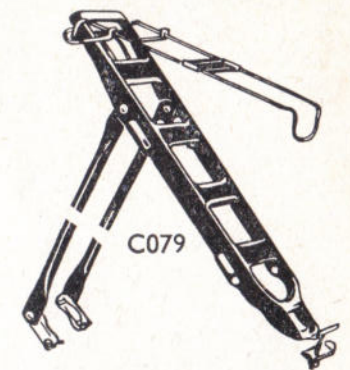

CHILD CARRIERS and AUXILIARY SEATS

C059	ASHBY	No. 15 Babscar. For attachment to rear of cycle. Exceptionally strong and rigid. Adjustable footrests. Seat and Backrest removable for conversion to luggage carrier	...	£1 8 0
C075	LECO	Child Carrier, for rear attachment, spindle fitting. Upholstered back and armrests ensure Kiddy's comfort	...	£1 7 6
E330	DERRETTS	Safety-auxiliary Saddle, comfortable rubber seat, top tube fittings, with footrest, fits lady's or gent's cycle	...	18/6
C076	LECO	upholstered child saddle, with footrest, top tube fittings	...	9/-

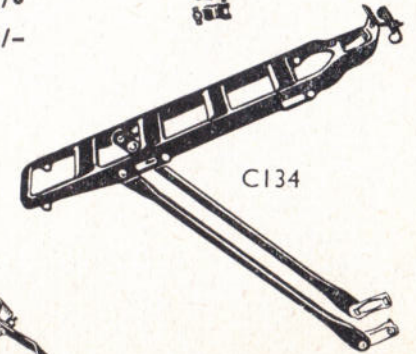
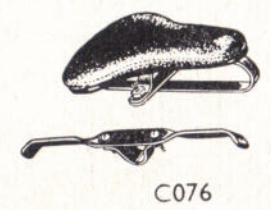
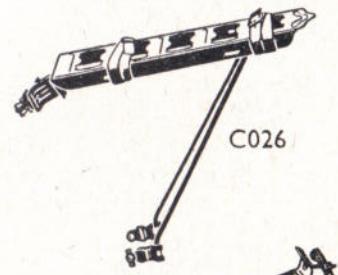

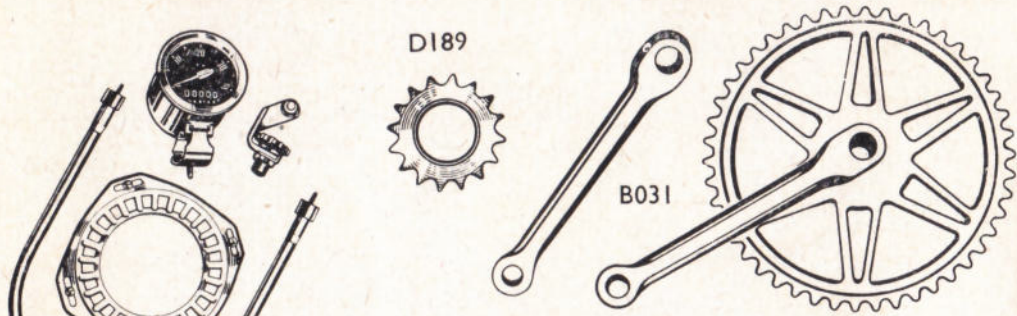

CHAINWHEEL and CRANK SETS

- D259 B031 46 Teeth x 1 1/2" x 1 1/2". Chromium Plated with 6 1/2" oval cranks, G.C.C. or Non-G.C.C. ... 15/3
- B030 48 Teeth with 7" oval cranks, G.C.C. ... 15/3
- B332 52 Teeth with 7" oval cranks, G.C.C. ... 16/6
- B038 44 Teeth with 6 1/2" cranks, G.C.C. Chrome ... 15/3
- B331 Junior Chainwheel sets ... from 12/6
- B035 Cranks only. Left-hand, Chromium Plated. 6 1/2" or 7" ... 5/6
- B032 Ditto, 5 1/2", 4 1/2" or 4" ... 5/-
- D189 Chain Sprockets, 1 1/2" x 1 1/8", 12, 13, 14, 15 and 16 Teeth ... 1/7
17 and 18 Teeth ... 1/9
- B042 Cotter Pins. Chromium Plated ... 3 1/2d.
- B043 Nuts only ... 1 1/2d.

CYCLOMETERS and SPEEDOMETERS

- D250 LUCAS Cyclometer, for 24", 26", 27" and 28" wheel ... 7/6
- D251 C.I. Cyclometers, for 26" wheel ... 7/6
- D258 LUCAS cyclometer strikers ... 6d.
- D253 SMITH'S Model 28T Speedometer, registering speed and mileage, standard fitting for 26" wheel £1 18 6
- D259 SMITH'S De-luxe Model 28. Suitable for power assisted cycles. 26" wheel £2 9 6

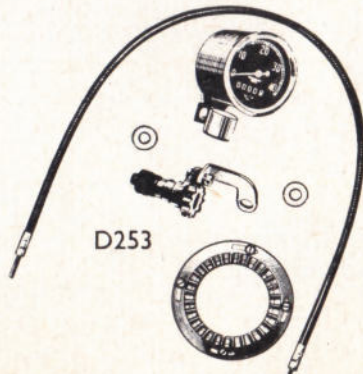
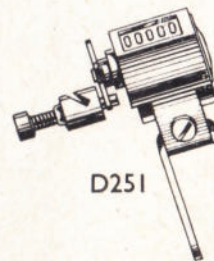
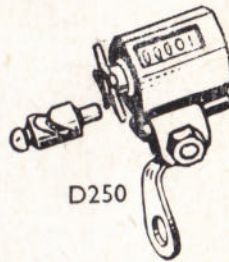

D259

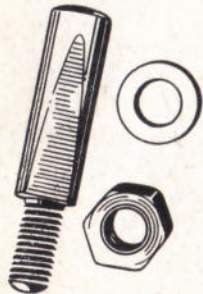

B042



B035



F046



F038



F047



F006



F005



F015

ENAMEL

- F310 JUDGE. Oil black, 2 oz. tin ... 10 1/2d.
- F026 JUDGE, black, 1/2 pint tin ... 1/10
- F028 ROBBIALAC Synthetic black, 1/2 pint tin ... 4/9
- F305 ROBBIALAC. 1/4 pint tins. Black, Blue, Ivory, Jade, Primrose, Signal Red, and White ... each 2/9
- F036 Ditto. 1/8 pint tins ... 1/7 1/2
- F038 ROBBIALAC Brushing Cellulose, 1/4 pint tins. Black ... 3/3
- F046 ROBBIALAC Cellulose Undercoat, 1/4 pint tin ... 2/9
- F047 ROBBIALAC Cellulose Thinners, 1/2 pint tin ... 3/3



F028



F305

BRUSHES (Enamel)

- F005 Small mop brush ... 6d.
- F006 Large mop brush ... 9d.
- F015 1/2" best bristle ... 1/3
- F016 1" best bristle ... 1/10

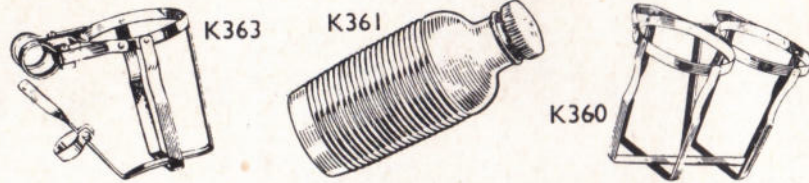

FEEDING BOTTLES

Take your refreshments with you
 K361 Made of ribbed alloy, 1 pint capacity, in the following anodised finishes:— Blue, Green, Gold, Red or Silver 4/6

FEEDING BOTTLE CARRIERS

K363 Single bottle type, alloy, anodised finishes:— Blue, Green, Gold, Red or Silver 4/6
 K360 Double bottle type, alloy, finish as above 7/9
 K354 Feeding Bottle spare corks 6d.

FEELER GAUGES

K001 VITREX No. 460. 10 blades 3/11

FREEWHEELS

D059 BAYLISS WILEY. 14 Teeth x 1/2" x 1/8" 4/5
 D060 BAYLISS WILEY. 20 Tooth x 1/2" x 3/16". Carrier Cycle 7/1
 D061 BAYLISS WILEY. 18 Teeth x 1/2" x 1/8" 6/8
 D064 VILLIERS. Midget, Tricycle. 14 Teeth 4/5
 D066 VILLIERS. 16 Teeth x 1/2" x 1/8" 7/2
 D063 VILLIERS. 18 Teeth x 1/2" x 1/8" 7/1

FORKS

E630 "D" Section Roadster type, for 24", 26" or 28" wheel 14/3

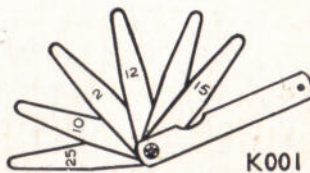
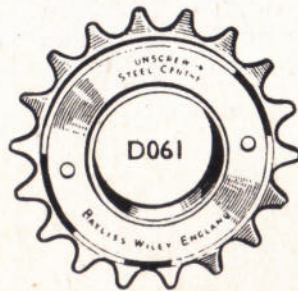

HANDLEBAR & BRAKE SETS

E181 North Road raised pattern. Chromium plated. Complete £1 17 0

HANDLEBAR BENDS

(Chromium Plated)

E201 North Road pattern ... 8/4
 E205 Allrounder pattern ... 7/10

HANDLEBAR STEMS

E220 Close-up chrome-plated, with expander bolt ... 9/10
 E221 2" forward extension ... 10/4
 E222 3" forward extension ... 11/10

HANDLEBAR END STOPS

E250 DUNLOP. Cream or Red Per Pair 1/9

HANDLEBAR EXPANDER BOLTS

B065 Complete with cone and washer. 8". Chromium plated ... 1/3

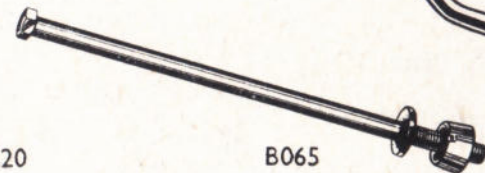
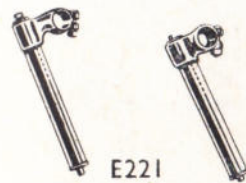
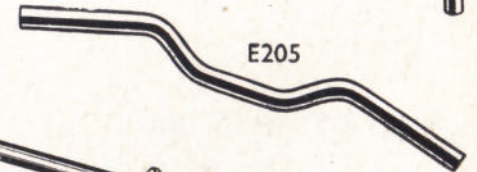
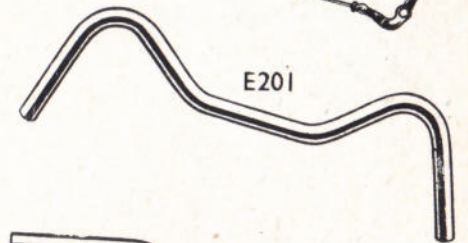
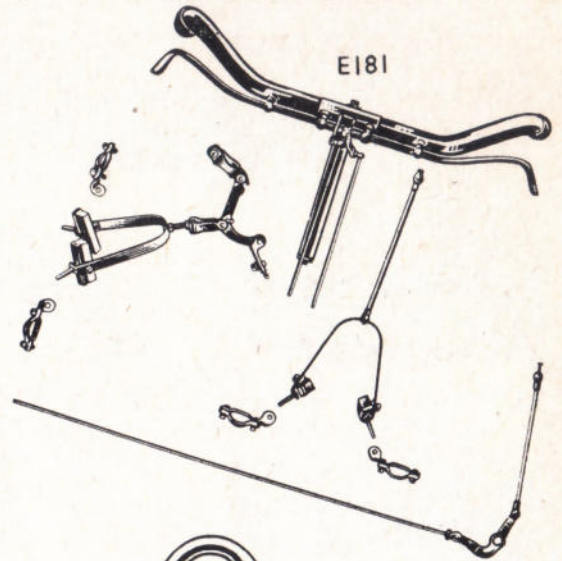

RALEIGH SPARES

MOST SPARES AND REPLACEMENT PARTS for RALEIGH INDUSTRIES MACHINES — including Raleigh, Rudge, Humber and Triumph models — can be obtained from your local branch of Currys, where a copy of the official SPARE PARTS LIST issued by Raleigh Industries is always available for immediate reference by all cyclists.

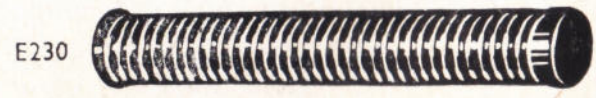
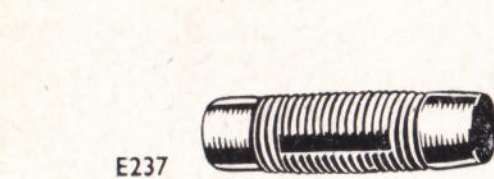

HANDLEBAR GRIPS

- E237 Junior Grips for $\frac{3}{4}$ " Bar. Rubber. Black Pair 7 $\frac{1}{2}$ d.
- E236 Juvenile Grips for $\frac{5}{8}$ " Bar. Rubber. Black Pair 7 $\frac{1}{2}$ d.
- E232 SHOCKSTOP No. 51. Rubber. 4 $\frac{3}{4}$ ". Black Pair 1/10
Red Pair 2/1
- E219 Finger Grips. Rubber. Black Pair 1/5
Beige or Grey Pair 1/10
- E230 SHELTON, 7" Sports, Celluloid, Red, Blue or Green Pair 3/6
- E259 SPORTS. 6 $\frac{1}{2}$ " rubber. Beige, Blue or Claret Pair 1/6

E237
E233
E219
E232
E259

E230

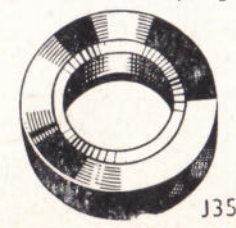
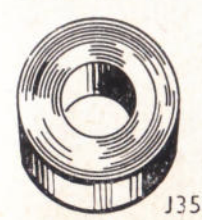
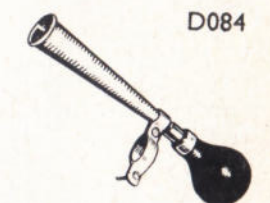
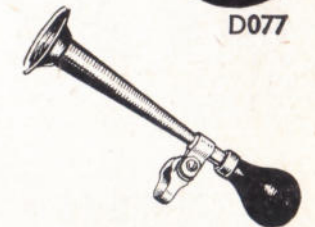
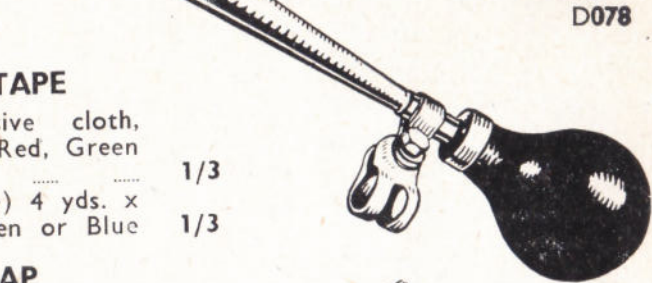
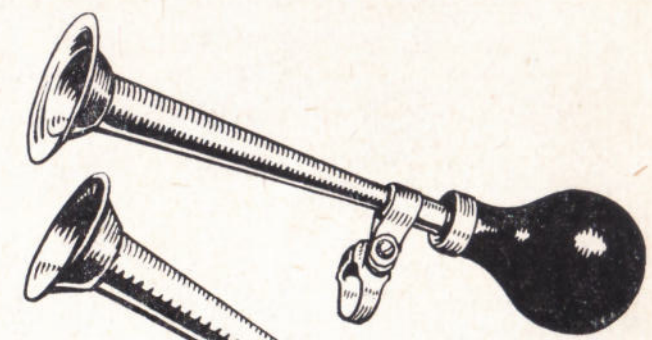
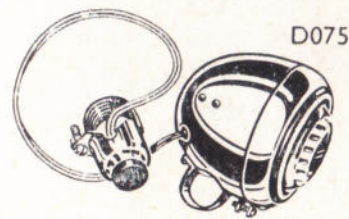

HANDLEBAR TAPE

- J350 TEX-O-TAPE. Adhesive cloth, 5 yds. x $\frac{3}{4}$ ". White, Red, Green or Blue 1/3
- J356 Plastic Tape (Opaque) 4 yds. x $\frac{3}{4}$ ". White, Red, Green or Blue 1/3

HAND SOAP

- H020 CHEMICO. No. 1 size tin 1/6
- H023 GRE-SOLVENT. large tin 1/2

HORNS

Bulb Type, Cycle & M/Cycle

- D227 Juvenile Pip-Pip Horns. Assorted Colours 1/9
- 2D074 STADIUM Nickel Plated, ditto 2/9
- D084 No. 8, small, silver finish 2/11
- D078 No. 9. Autocycle type. Chrome finish 4/11
- D077 Motor Cycle Horn. Chrome Plated 6/11

ELECTRIC HORNS (Cycle)

- D075 No. 545 "Cadet" electric. Silver and Chrome 16/6
- D076 VIDOR electric, silver finish 6/11 $\frac{1}{2}$

J356

J350

H020

HUBS — SPINDLES — NUTS at **Currys** LTD.

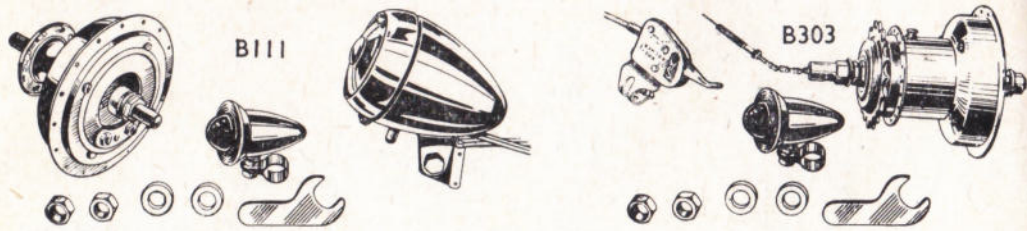

HUBS

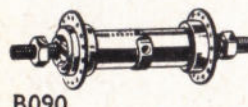
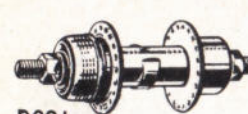
	B090 BAYLISS-WILEY "Ideal" Roadster, Front	5/6
	B091 BAYLISS-WILEY "Ideal" Roadster, Rear	7/4
	B092 BAYLISS-WILEY "Ideal" Racing, Front	5/7
	B094 BAYLISS-WILEY "Ideal" Racing, Rear, Double-sided	8/-
	B100 PERRY "Coaster" Rear brake hub, with 18T x 1/2 x 1/2 sprocket	£1 7 6
	B097 STURMEY-ARCHER Model A.W. 3-speed hub with trigger control	£2 4 6
	B111 STURMEY-ARCHER G.H.6. Front Dynohub complete with front and rear lamps	£2 14 9
	B303 STURMEY-ARCHER AG. Dyno-3-speed hub complete with front and rear lamps	£4 10 4

Full range of STURMEY-ARCHER 3- and 4-speed hubs, wide, medium, and close ratio, always available

HUB SPINDLES, CONES, NUTS and WING NUTS

	B112 BAYLISS-WILEY standard spindles complete, Front	2/1 1/2
	Rear	2/4 1/2
	B115 Standard spindles complete,	Front 1/3
	Rear	1/6
	B124 Front Cones, fixed or adjusting	4 1/2 d.
	B125 Rear Cones	5d.
	B120 Spindle Nuts, Front and Rear	1d.
	B118 Track Nuts, Chrome Plated, Front and Rear	4d.
	B259 Wing Nuts, Alloy, Polished Chrome Plated, Front and Rear	Pair 1/6
	B255 Wing Nuts, lever type, Chrome Plated, Front and Rear	Pair 1/9

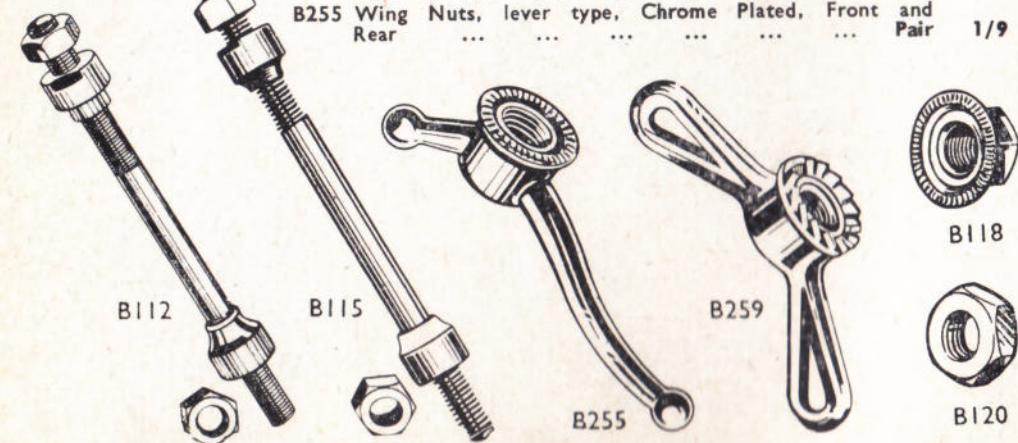

Sturmey-Archer GEARS, HUB-DYNO UNITS & SPARES

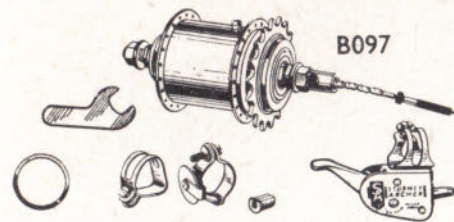

Sturmey - Archer

We illustrate here an "exploded" diagram of the famous Sturmey-Archer Model AW Wide Ratio 3-Speed Hub which sells complete with top-tube or trigger control at **44/6**

All CURRYS' Shops maintain a comprehensive stock of the small parts which are used in the assembly of this and other Sturmey-Archer Hubs. Should you have the misfortune to lose, or damage any of the parts which make up the hub of your cycle you can rest assured that CURRYS are able speedily to replace them. All you have to do is to quote the part number shown in the diagram. Should your hub not be a Model AW further similar diagrams of all Sturmey-Archer products can be seen at your local CURRYS' branch.

CONTROL WIRES

TOP TUBE 1/5 TRIGGER 2/6

CURRYS also stock a comprehensive range of

Raleigh Spares

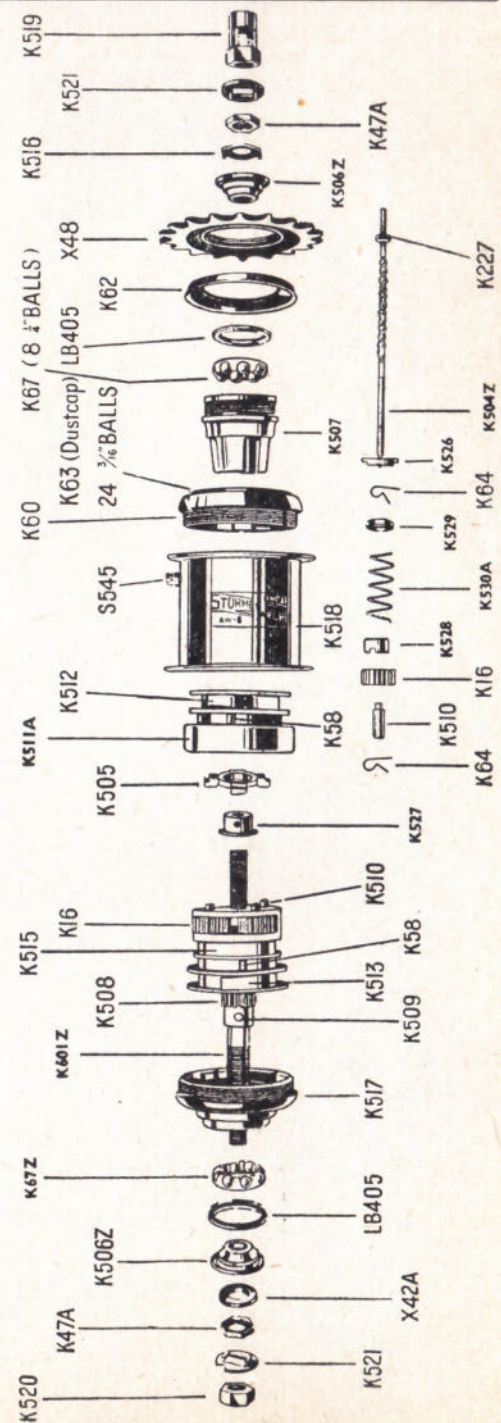



H173



H171

HOLT'S MOTORING PRODUCTS

- H171 GUN-GUM, silencer seal (tin) 3/6
- H172 LOY, plastic metal, (small tube) 3/-
- H174 RADWELD, radiator seal, (tin) 3/6
- H173 Valve Grinding Paste (tin) 2/-
- H175 Wonder Weld, engine block seal, (tin) 8/6

INSULATING TAPE

- J019 Special. 5 yd. roll, 1/2" wide 6d.
- J016 Special. 10 yd. roll, 1/2" wide 10d.
- J377 DUNLOP. 5 yd. roll, 5/8" wide 9d.
- J013 DUNLOP. 10 yd. roll, 5/8" wide 1/3
- J014 SEEROL. 2 1/2 yd. roll, 3/4" wide 4 1/2 d.
- J375 SEEROL. 5 yd. roll, 3/4" wide 10d.



H172



H174



H175

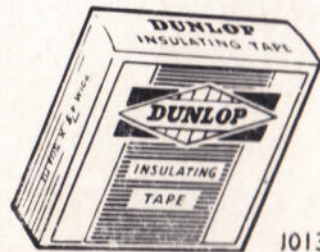

J013

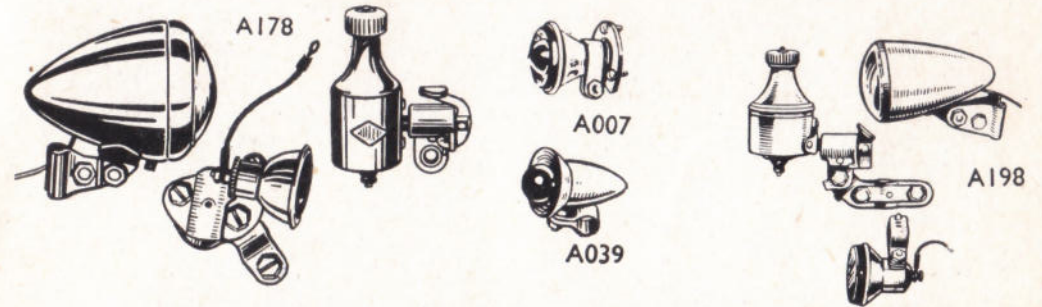

DYNAMO LIGHTING SETS

- A198 SPECIAL, "Golden Star" complete as illustrated ... £1 1 0
- A192 LUCAS "Pathfinder", stand-by battery type, Silver finish ... £2 2 0
- A189 LUCAS "King Major". Stand-by battery type. Silver finish ... £2 2 6
- A191 LUCAS "King Minor". Non-battery type. Silver finish ... £1 15 0
- A008 MILLER No. 536T. Stand-by battery type. Silver or black enamel finish ... £1 17 6
- A177 MILLER No. 537T, as above, but all chrome plated finish ... £2 2 6
- A178 MILLER No. 535T. Sports set, chromium plated ... £1 12 6
- A202 MILLER No. 539T. Non-battery type, chromium plated ... £1 15 0

DYNAMO HEAD and TAIL LAMPS

- A276 LUCAS No. H.C.4. "King Sports" Headlamp including bulbs, silver finish ... 14/-
- A014 MILLER No. 6. Headlamp, black and chrome ... 16/6
- A016 TREHAWK. Chrome headlamp with bulb and cable ... 9/6
- A057 LUCAS V.T.31.CA. Rear lamp, for number plate illumination, 1 1/2" diameter ... 5/-
- A052 LUCAS, C.T.90, rear lamp/reflector ... 5/11
- A007 STADIUM No. 747. All plastic rear lamp, 1 1/2" diameter ... 2/6
- A039 STURMEY-ARCHER M.65 with 6 volt 0.04 amp. bulb, 1 1/2" diameter ... 3/3
- A019 STADIUM No. 553. Rear lamp ... 5/-
- A119 B. & T. Safety rear lamp and reflector combined ... 5/6

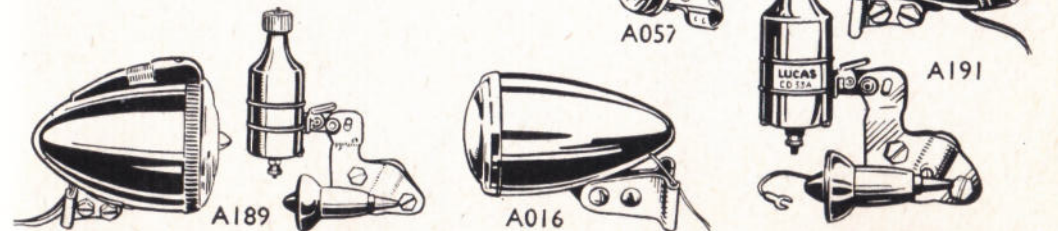

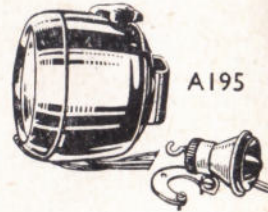
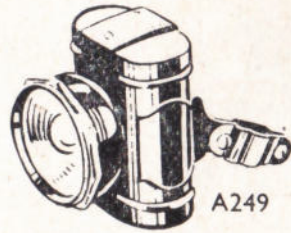
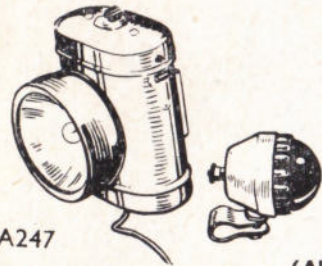

FRONT BATTERY LAMPS

(All taking No. 800 battery unless otherwise stated. Prices include bulbs, less batteries)

- A244 EVER READY No. 2306, with positive on/off switch. Available in Black, Blue, Green or Silver 3/9
- A249 EVER READY No. 2307. Hexagon Front, complete with fork bracket. Black or Silver 4/3
- A227 EVER READY No. 2536, as above, but less fork bracket. Black or Silver 4/-
- A225/6 EVER READY No. 2236. Black or Silver, with 3" lens 7/6
- A245 CURRY SPECIAL as featured, black enamel, case only 2/11

LAMP SETS

(Front and rear lamps with cable and bulbs, less batteries)

- A195 LUCAS No. 431. Lamp-set, rubber mounted socket. Silver and chrome finish £1 6 0
- A206 MILLER No. 6TM. Lamp-set. Silver finish £1 5 0
- A247 STARLIGHT No. 1246. Lamp-set. Silver finish 9/3

Note: Lucas 431 and Miller 6TM, incorporate number plate type rear lamps, and are suitable for power assisted cycles

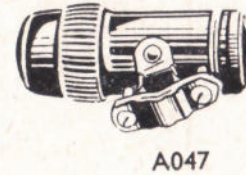
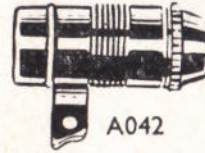
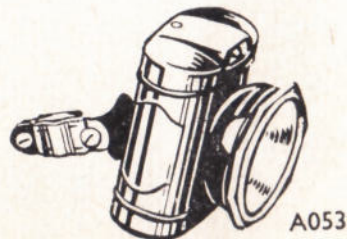
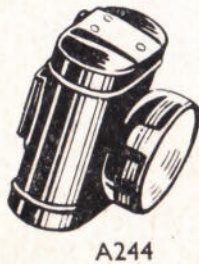
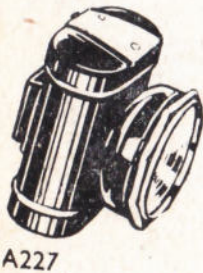
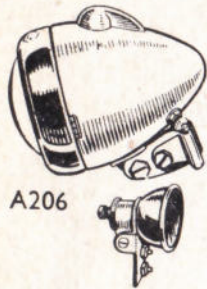

REAR LAMPS, BATTERY, with bulb, less battery

- A047 EVER READY No. 2339. U2 Battery type. Complete with bracket. Finished in Black, Blue, Green, or Silver 2/6
- A053 EVER READY No. 2308. No. 800 Battery type. Black or Silver 4/3
- A042 G.E.C. No. BA152. U2 Battery type. Black or Silver 2/6

LAMP BRACKETS

- A086 ASHBY No. 1 front fork fitting. D Section. Black 11d.
- A072 ASHBY No. 1C, rear fork fitting. D Section. Black 11d.
- A105 ASHBY No. 14, head fitting, extra strong, chrome plated 2/6
- A075 ASHBY No. 16, front and rear fork, round section. Black 1/9
- A076 ASHBY No. 18, front fork. D Section, ratchet adjustment. Black 2/-
- A110 TERRY No. 1095A clip-on basket type, black enamel 1/3

LICENCE HOLDERS

- H214 Motor cycle, fork-nut fitting, black 1/9
- H215 VACUON, car, suction type, chromium plated 6/-
- H217 PLASTIC No. 163 1/-
- H212 BAKELITE, windscreen, stick-on type 3/-

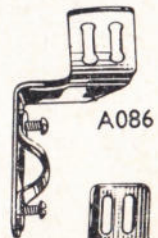
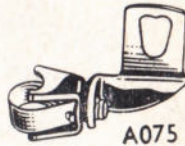
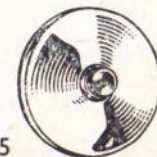
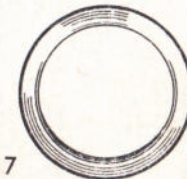
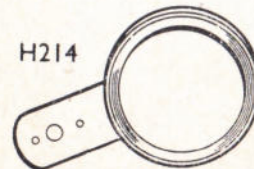

BRITAIN'S No. 1 VALUE IN CYCLE LAMPS
2/11

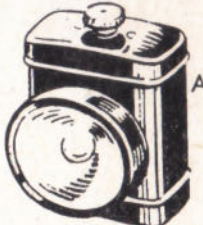

A245

Takes 800 type battery

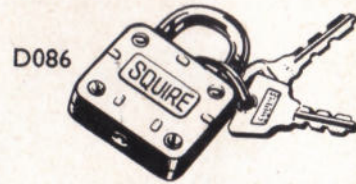
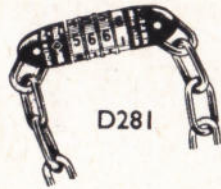

CYCLE LOCKS

- D089 Padlock, 1 1/8", No. S1160, cadmium plated 1/-
 - D087 SQUIRE, No. 34/40, 1 1/2" spring padlocks 2/-
 - D086 SQUIRE, No. 06, spring padlocks, cadmium plated 2/8
 - D281 COMBINATION LOCK, C.I. Model LC/3, with welded chain 6/-
 - D280 ADIE, acorn lock and chain, assorted colours 3/9
 - D283 LUCAS "Gem" with chain, screw-in key 5/6
- Replacement keys for Lucas "Gem" and Adie "Acorn" locks 9d.

CHAINS

- D285 Nickel plated chain with welded end rings 6d.
- D095 Nickel plated chain with welded links and end rings 1/-

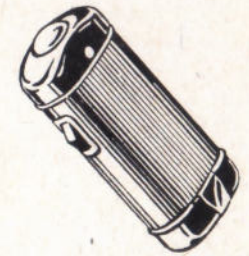
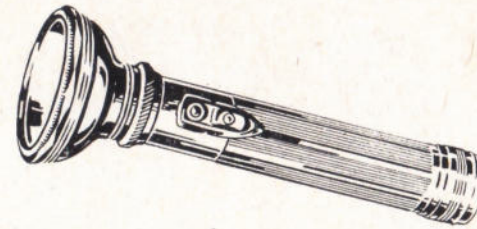
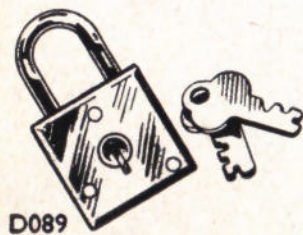

TORCHES (Case & Bulb Only)

- Empire Nickel plated :
- 2" Head Focussing 4/8 incl. Tax
 - " 3 1/4" Head 6/6 " "
 - " 3 1/2" Head 8/11 " "
- Ever Ready Black & Electro :
- Bright Bijou 3/7 incl. Tax
 - Baby 4/9 " "
 - Large 6/- " "
- Ever Ready No. 8188 Pocket Lamp 3/11 " "
- Ever Ready Slim Penlight 4/9 " "
- Vidor 2 cell Rubber 9/- " "
- Vidor 3 cell Rubber 11/- " "

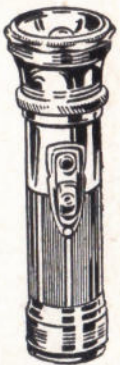



BATTERIES

- | | |
|--|------|
| 1915 Fountain Pen Torch Battery | 7d. |
| U16 Unit Cell for Slim Pen-Light
(2 units per torch) each | 4½d. |
| U2 Unit Cell | 7d. |
| No. 8 Bijou Two Cell | 7d. |
| N.1839 Baby Two Cell | 10d. |
| No. 800 Cycle Lamp Two Cell | 1/4 |
| Ray-o-Vac Leakproof Unit Cell | 9d. |
| Ray-o-Vac Leakproof No. 800 size | 1/9 |

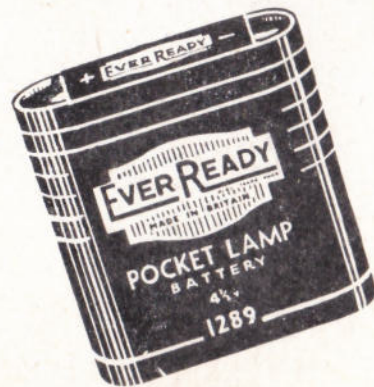

- | | |
|--|-----|
| No. 126 3 Cell screw terminal Box Battery (Bell) | 2/9 |
| No. 1289 3 Cell Flat | 1/- |



A full range of Ever Ready and other popular makes of batteries (not listed here) is always available in every branch of CURRYS

It's never far to the nearest
CURRYS
for every cycling need

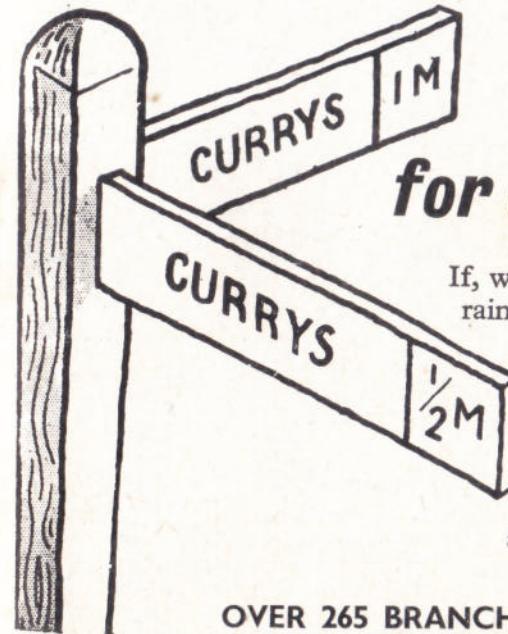

If, when touring, you need a new tyre or tube, a rainproof cape or any other cycle accessory, *the* place to get *exactly* what you want is Currys. Their choice is simply amazing. It will always pay you to make for the nearest Currys when you want something in a hurry. Currys have hundreds of branches throughout the country — a comforting thought when far from home!

OVER 265 BRANCHES THROUGHOUT GT. BRITAIN

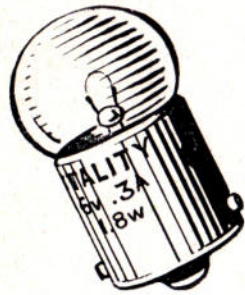

TORCH BULBS

Every Ready	1.25 volt	.25 amp	11 mm.	spot	MES	5d.
Every Ready	2.5 volt	.22 amp	11 mm.	S. Filament	MES	5d.
Every Ready	2.5 volt	.3 amp	11 mm.	spot	MES	5d.
Empire	2.5 volt	.3 amp	11 mm.	spot	MES	3d.
Empire	3.5 volt	.3 amp	11 mm.	spot	MES	3d.
Every Ready	3.5 volt	.3 amp	11 mm.	spot	MES	5d.
Mazda	4.5 volt	.3 amp	15 mm.	spot	MES	5d.
Every Ready	2.2 volt	.25 amp		Lens end	MES	8½d.

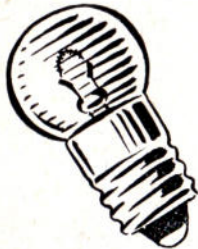

CYCLE LAMP BULB

6 volt	.2 amp	15 mm.	MES	Vitality	11d.
		15 mm.		Every Ready	10d.
6 volt	.25 amp	15 mm.	MES	Vitality	11d.
6 volt	.3 amp	15 mm.	MES	Vitality	11d.
		15 mm.		Every Ready	10d.
6 volt	.5 amp	15 mm.	MES	Vitality	11d.
		15 mm.		Every Ready	10d.
6 volt	.1 amp	11 mm.	MES	Every Ready	10d.
6 volt	.04 amp	11 mm.	MES	Vitality	9½d.
		11 mm.		Every Ready	10d.
6 volt	.3 amp	18 mm.	SCC	Mazda	1/7½d.
6 volt	.5 amp	18 mm.	SCC	Mazda	1/7½d.
6 volt	1.0 amp	18 mm.	SCC	Miller	1/11d.
Festoon Bulbs for Brierley safety signal				6 volt .15 amp	2/0½d.



CYCLEMASTER BULBS

6 volt	8 watts	18 mm.	SCC	Vitality	2/0½d.
6 volt	1.2 watts	15 mm.	MES	Vitality	11d.
6 volt	1.5 watts	15 mm.	MES	Vitality	11d.
6 volt	1.8 watts	15 mm.	MES	Vitality	11d.
6 volt	6 watts	15 mm.	MES	Vitality	11d.
6 volt	8 watts	15 mm.	MES	Vitality	11d.

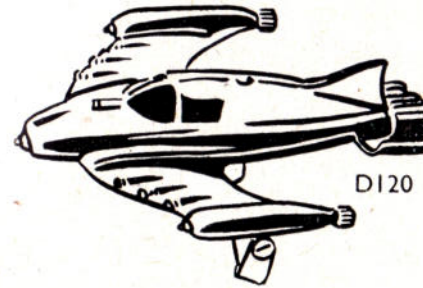

D120

LEARNER PLATES

H246 Metal base	Pair	1/9
H247 Plastic base	Pair	1/10

MASCOTS (Cycle)

D120 Space Scout Mascot, mudguard fitting	1/-
---	-----

MIRRORS, Cycle, M/Cycle and Car

H450 Handlebar mirror, cycle, aluminium arm and frame, 3 1/8" diameter glass	2/9
H451 Handlebar mirror, cycle, aluminium arm and frame, oblong glass 2 7/8" x 1 3/8"	2/7
H456 STADIUM No. 284. Windscreen mirror, polished alloy frame	3/3
H452 STADIUM No. 288, round glass, chrome plated frame	6/6
H453 STADIUM No. 290, oblong mirror with chrome bezel	7/6
M454 STADIUM No. 296C, motorcycle mirror, chrome plated	14/6

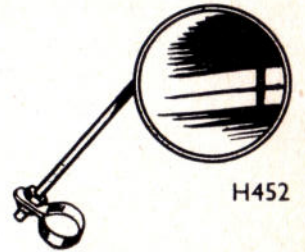

H452



H450

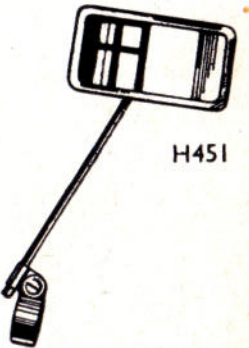

H451



H456

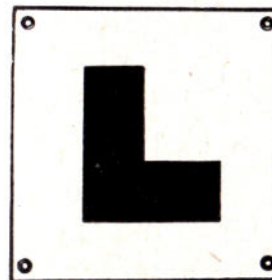

H246

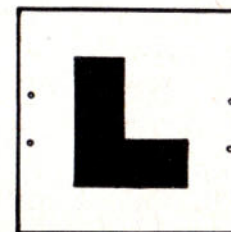

H247

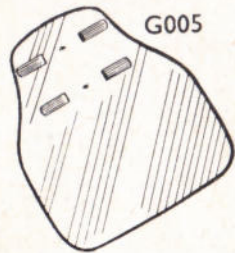

G005

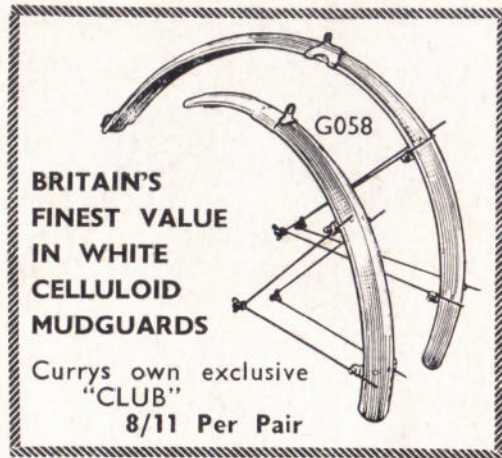

**BRITAIN'S
FINEST VALUE
IN WHITE
CELLULOID
MUDGUARDS**

Currys own exclusive
"CLUB"
8/11 Per Pair

MUDFLAPS

- G004 VYBAC No. 1, white plastic, 7 $\frac{1}{4}$ " x 5 $\frac{1}{2}$ " 1/-
- G001 MIDLAND No. 491, 10" x 9", black Plastic 1/6
- G003 MIDLAND No. 502, 13 $\frac{1}{2}$ " x 9", shaped, black japanned 2/9
- G009 MIDLAND No. 674, 7 $\frac{1}{4}$ " x 5 $\frac{1}{4}$ ", black Plastic 8d.
- G002 BROOKES No. 2292, 7 $\frac{1}{2}$ " x 5 $\frac{1}{4}$ ", white 1/6
- G005 VYBAK No. 2, white plastic 1/9

MUDGUARDS

- G020 Roadster pattern, metal mudguards, black, 26" or 28" wheel Pair 3/11
- G024 Sports pattern, plain black, metal, stay fitting Pair 3/11
- G026 Sports pattern, white, metal, stay fitting Pair 5/6
- G041 Popular Roadster, wide section, polished alloy Pair 5/6
- G057 Currys "Sports", white celluloid, 2" narrow section Pair 7/11

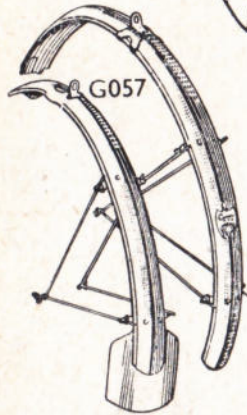

G057



G062

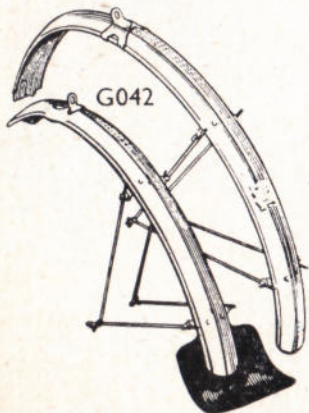

G042



G004



G002

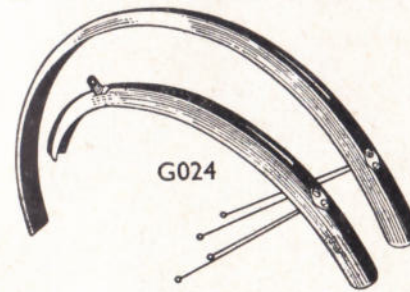

G024

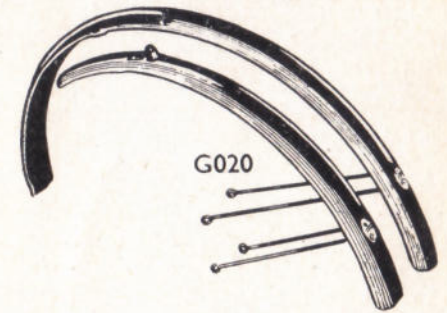

G020

- G058 Currys "Club", white celluloid, 2 $\frac{1}{4}$ " wide section Pair 8/11
- G055 Currys "Sports", celluloid, red or blue, with reflector and mudflap Pair 9/11
- G042 APEX Sports, white celluloid, stay fitting, with mudflap Pair 11/6
- G034 BLUEMEL'S "Noweight", white celluloid, stay fitting Pair 13/6
- G027 Juvenile mudguards, metal, for 14", 16" or 18" wheel, black Pair 2/11
- G016 Juvenile mudguards, metal, ribbed section, for 14", 16" or 18" wheels, white Pair 4/3
- G030 Juvenile mudguards, metal, for 20" or 24" wheel, black Pair 3/3
- G018 Juvenile mudguards, metal, ribbed section, for 20" or 24" wheel, white Pair 4/6
- G062 Mudguard bridge, alloy, sliding type for rear sports guards Pair 6d.



G003



G009



G001

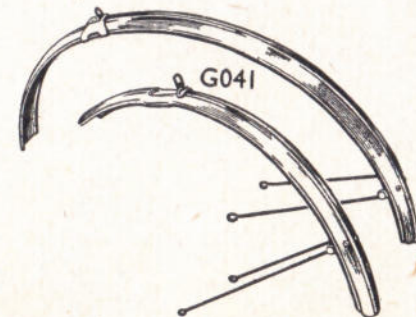

G041

LUBRICATING OIL & OILCANS at **Currys** LTD.

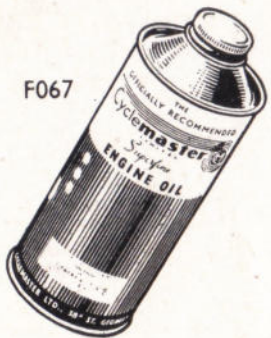

F067



F053



F059



F057



F064

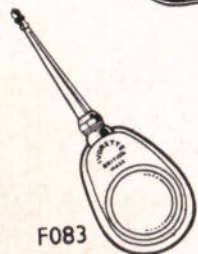

F083

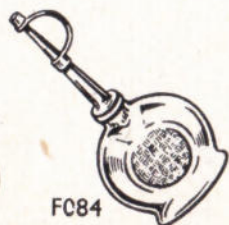

F084

UNIQUE VALUE in RUBBER PEDALS

Chrome Plated, Ladies & Gent's

Pair 5/6 D177

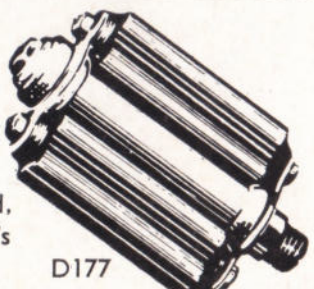

OIL (Lubricating)

F052 3-IN-ONE, 3 oz. bottle	1/-
F053 3-IN-ONE, 6 oz. bottle	2/-
F059 3-IN-ONE, 8 oz. tin, with spout	2/9
F064 RALEIGH, 8 oz tin, with spout	1/6
F057 EXCELENE, 4 oz. tin, with spout	1/-
F061 EXCELENE, 7½ oz. tin, with spout	1/4
F058 3-IN-ONE GREASE, 4 oz. tube	2/6
F067 CYCLEMASTER OIL, quart tin	3/10
F060 PHILLIPS 803, with spout	1/6
F069 CASTROL 2 stroke	2/2

OILCANS

F084 Polythene, transparent oilcan	10d.
F083 Celluloid, transparent oilcan	1/6
F085 Tin-plate	9d.
F112 WESCO No. 3300. Large capacity, lever action	5/6

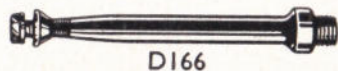

D166

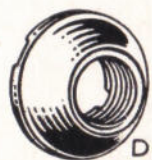

D160

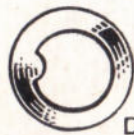

D161



D340

Currys for PEDALS and PEDAL SPARES

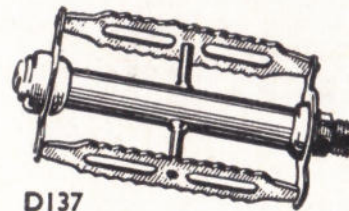

D137

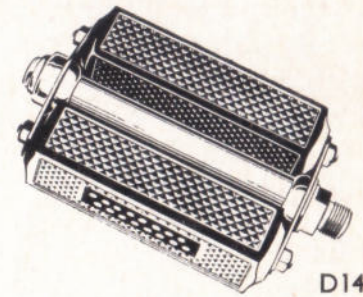

D142

PEDALS

D137 4" Rat-trap, chromium plated	Pair	5/6
D136 PHILLIPS No. 61 "Celtonia", 4" Rat-trap, chrome	Pair	7/1
D138 PHILLIPS Nos. 75 and 76 "Philco" Rubber. Ladies and Gents	Pair	7/1
D179 PHILLIPS No. 58 "Credex" 3" Junior, chrome plated	Pair	6/6
D142 RUBBER PEDALS with SAFETY Reflector	Pair	10/-

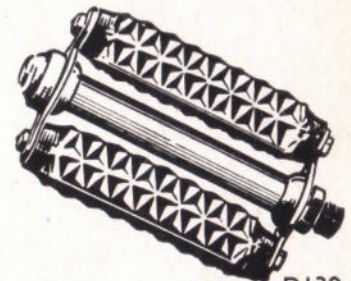

D138

PEDAL SPARES

D166 Pedal spindles, left or right, with cone and locknut, Ladies and Gent's	1/-
B340 Pedal bar nuts, for rubber pedals	½d.
D160 Pedal cones	2d.
D161 Pedal cone washers	1d.
D162 Pedal cone locknuts	1d.
D174 Pedal dust caps, chrome, for Phillips Nos. 58, 61, 65, 66, 83 and 98 pedals	2d.
D173 Pedal rubbers, set of 4, diamond pattern, Ladies and Gent's	Set 1/4
D350 Pedal rubbers, Juvenile 3"	Set 11½d.

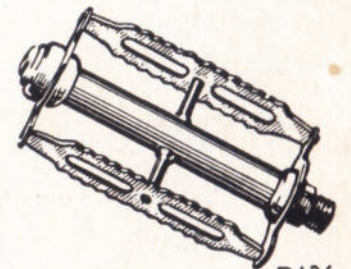

D136



D174



D162

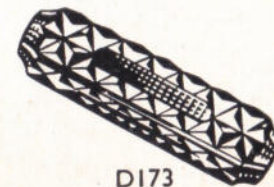

D173

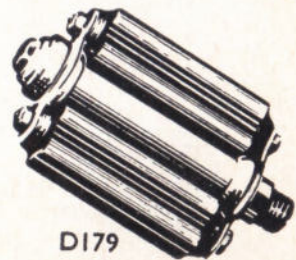

D179

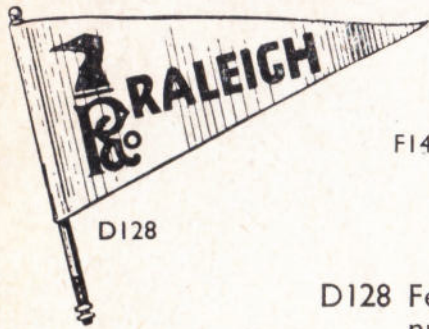

D128



F143

F104



- PENNANTS (Cycle)**
D128 Felt pennants, with standard and nuts, Raleigh, Triumph, Rudge, Humber and Phillips 1/4

POLISHES and CLEANERS

- F104 Petroleum Jelly, Excelene, 5 oz. tin (industrial) 1/3
F147 AUTOBRITE, 8 oz. bottle 5/-
F128 KARPOL, tin 3/-
F143 SIMONIZ wax polish, large tin 7/-
F144 SIMONIZ Kleener 5/-
F145 SIMONIZ chrome cleaner, 8 oz. tin 2/6
F151 SIMONIZ Liquid Kleener 5/-
F150 SIMONIZ "Bodyglaze" liquid wax polish 5/-
F141 Johnson's CARPLATE polish, tin 5/-
F140 3-IN-ONE Cycle and M/cycle polish, 4 oz. bottle 2/6
H001 NENETTE Polisher & Cleaning Mop 13/9
H002 NENETOL Refills for above 3/3



F144



F145



F150



F128



F141

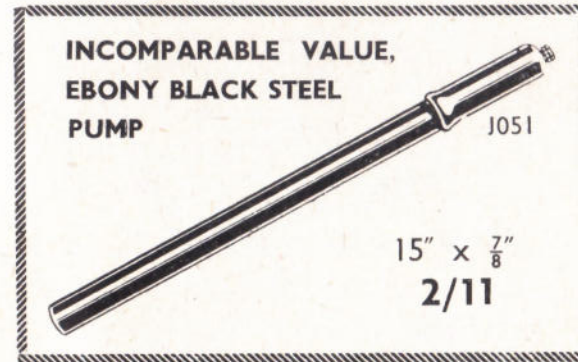

INCOMPARABLE VALUE,
EBONY BLACK STEEL
PUMP

15" x 7/8"
2/11

J051

PRESSURE GAUGES

- H282 DUNLOP, standard, car or motorcycle, 6-50 lbs. 8/6
H281 DUNLOP, Model G20, for easy pump valve 8/6

PUMPS

- J045 APEX, Baileys "Super", 15" x 7/8", black 6/-
J060 APEX, Baileys "Superlite", 15" x 7/8", white 5/-
J047 APEX, "Lastwel", celluloid, 15" x 7/8", black 4/6
J328 BLUEMELS, plastic, 12" x 7/8", black ... 5/-
J041 BLUEMELS "Featherweight", celluloid, 15" x 7/8", black 6/3
J321 BLUEMELS "Tour de France", celluloid, Red, White, Blue, Gold, Green and Grey 7/3
J332 DUNLOP, black celluloid, 15" x 7/8" ... 5/-
J327 BLUEMELS ringed, 15" x 7/8", white ... 5/9
J329 BLUEMELS plastic, 12" x 7/8", white ... 5/3
B172 Pump Clips, 1 1/4" diameter standard, and 7/8" diameter juvenile, black ... Pair 7 1/2d.

PUMP CONNECTIONS

- J070 BLUEMELS No. 9, 5" long 1/-
J079 BLUEMELS No. 9A, high pressure ... 1/-
J188 BLUEMELS "Motobike" No. 14, 15" long 1/10
J183 JOHN BULL, 32" long 6/6
J069 JOHN BULL, 5" long, braided 11d.



B172

J070



H282

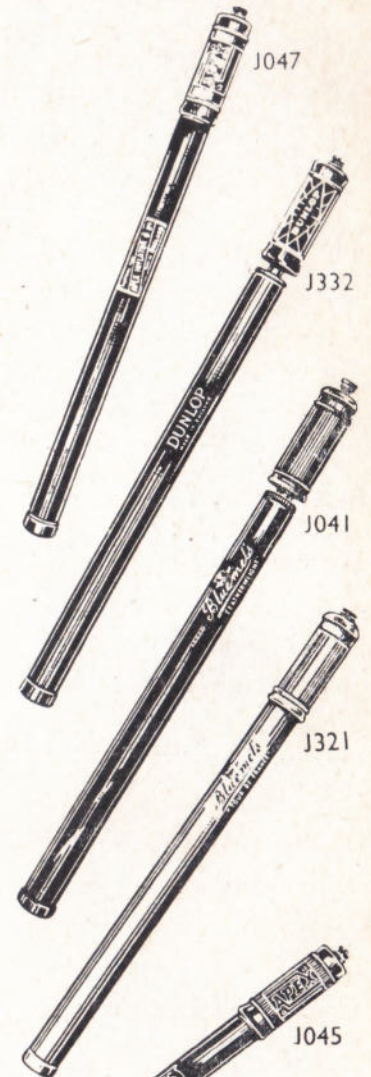
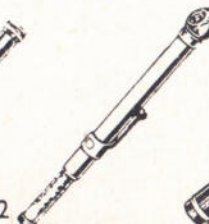

J047

J332

J041

J321

J045

H281



J100



A124

REFLECTORS, Cycle

- A099 BLUEMELS No. 7, stay fitting, white plastic 2/3
- A090 LUCAS No. 43, mudguard fitting 1/-
- A091 LUCAS No. 46, mudguard flush fitting 1/3
- A092 LUCAS No. 47, moulded rubber. (Raleigh type) 1/3
- A101 LUCAS No. 45. Stay Fitting 1/-



A092

REFLECTORS, Car

- A120 FAIRYLITE No. 67B, white enamel, bumper bar fitting 2/-
- A122 LUCAS R.E.R.2, shaped moulded rubber 2/3
- A123 STADIUM No. 571S, rubber mounted, chrome bezel 2/-
- A121 WINGUARD No. 922, rubber moulded 1/6
- A124 Spare reflector lens. Lucas 1 1/2" 4d.

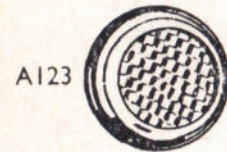

A123

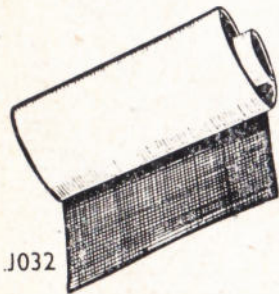

J032

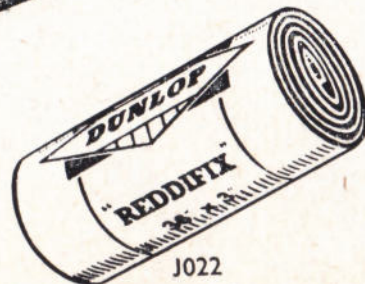

J022



J020

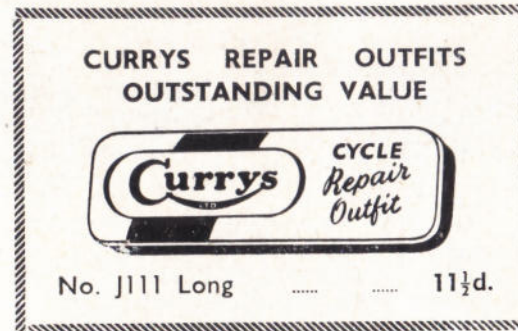

REPAIR OUTFITS

- J100 DUNLOP midget 1/-
- J101 DUNLOP long 1/6
- J111 CURRY long, as featured 11 1/2 d.
- J103 CHEMICO long 1/6
- J109 JOHN BULL long 1/6
- J112 CURE-C-CURE patent process 1/9
- J106 MEND-A-TEAR outfits, fawn, grey and black 2/1
- J200 DUNLOP R.O/15. motorcycle outfit 4/-
- J207 JOHN BULL motor kit 5/6

REPAIR PATCHES & PATCHSTRIP

- J020 DUNLOP "Reddifix" patches, packet of 7 assorted 4d.
- J022 DUNLOP "Reddifix" patchstrip, roll 36" x 3" 3/9
- J031 DUNLOP "Reddifix" patchstrip, roll 9" x 3" 1/3
- J023 CHEMICO patchstrip, roll 36" x 3" 3/-
- J032 CHEMICO patchstrip, roll 9" x 3" 10d.
- J028 CURE-C-CURE, strip of 8 patches 7 1/2 d.
- J002 FRENCH CHALK, small tin, sprinkler type 7 1/2 d.

RUBBER SOLUTION

- J120 DUNLOP small tube 5d.
- J121 DUNLOP large tube 7d.
- J122 DUNLOP small flask 1/-
- J124 JOHN BULL large tube 7d.



J106



J103



J112



J002



J120



J124

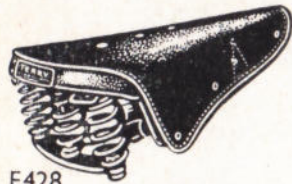

E428



E273



E416

SADDLES

- E286 MANSFIELD "Onward" 3 coil leather, Ladies and Gent's ... 16/6
- E430 BROOKS B.17, finest Butt, leather racing saddle ... £2 6 6
- E338 LYCETT S.21, girder frame, spring seat, soft top ... 17/-
- E428 TERRY 3 coil, spring seat, soft top, Ladies and Gent's ... £1 5 0
- E310 WRIGHTS S65/3, under-sprung saddle for power assisted cycles ... £1 7 6
- E273 WRIGHTS 11A Juvenile spring seat saddle, 7/8" clip, black soft top ... 11/9
- E274 WRIGHTS 11A Juvenile spring seat saddle, 3/4" chrome clip, dark tan top ... 12/9
- E416 LYCETT L.3, tricycle saddle, with clip ... 9/-

SADDLE COVERS

- E332 No. 37 Slip-on, special quality ... 2/6
- E336 Slip-on waterproof with Sorbo interior 3/11

SADDLE SPRINGS

- E340 4 coil ... 4 1/2 d.
- E341 3 coil ... 4 d.

SEAT PILLARS

- B186 "L" type, 7" x 4" chromium plated ... 3/-
- B181 Straight, 9" chromium plated ... 2/-

SPONGES (Synthetic)

- F170 SPONTEX, medium size, cellulose rubber 4/6
- F171 Large size ... 6/6

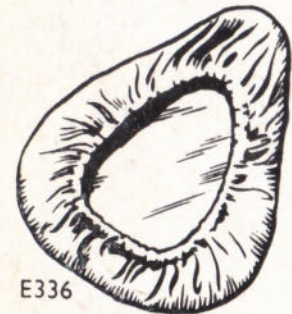

E336



E341

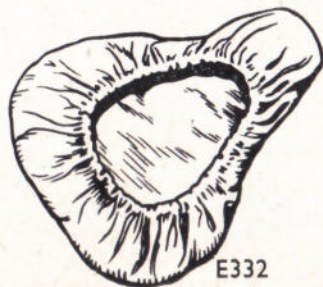

E332

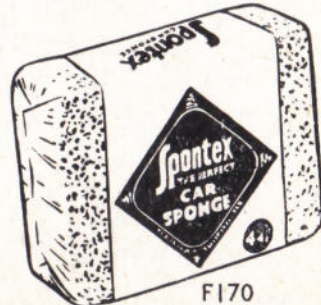

F170

TIP - TOP VALUE IN HUB NUT BOX SPANNERS



H069

7 1/2 d.

SEALING COMPOUND and ADHESIVE

- J129 BOSTIK No. 692 sealing compound, large tubes ... 3/6
- J130 BOSTIK No. 292 adhesive, small tubes ... 1/4

Z.B. SAFETY SIGNALS (as illustrated)

Incorporates direction indicator, large rear light and rear reflector. Can be used with existing dynamo set, or with batteries.

- C320 Ladies and Gent's models ... £1 8 6
- C322 Battery case for both models ... 6/6

SPANNERS

- H084 LUCAS "Girder Minor", No. 90, 3 1/2" ... 10/6
- H060 Peg and cone ... 4d.
- H059 BROOKS No. 3 peg and cone ... 11d.
- H061 ASHBY No. 5 universal set of 3 ... 1/6
- H062 ASHBY No. 7 six way ... 9 1/2 d.
- H067 TEN HOLE "Dumbell" ... 1/1
- H082 SIX HOLE "Dumbell" ... 10d.
- H069 No. 75D Hub nut, box spanner ... 7 1/2 d.
- H030 Spoke nipple key, 4-way, cycle size only
- H032 BROOKS No. 3, 6-way nipple key, cycle and m/cycle ... 1/-
- H031 ABINGDON single arm nipple key, cycle only ... 1/1
- B190 SPOKES. 14G and 15G all standard lengths 1d.
- B196 Spoke nipples. 14G and 15G, rolled thread Doz. 6d.

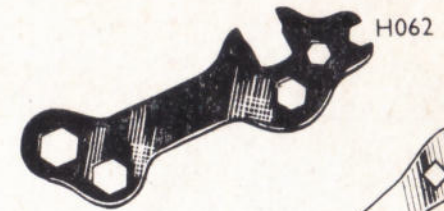

H062

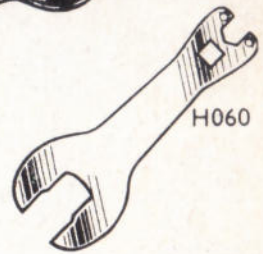

H060

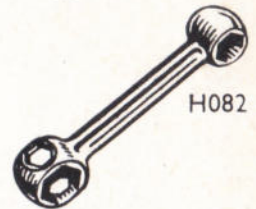

H082

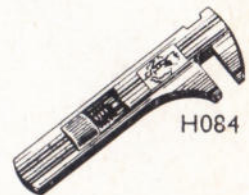

H084



H030



J129



J130

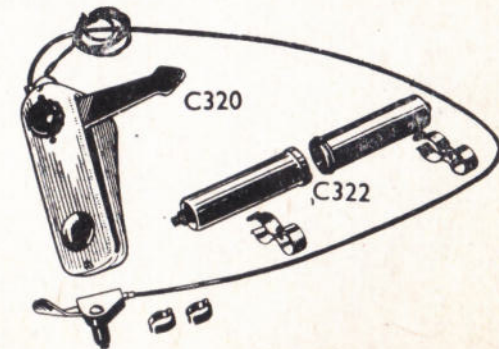

C320

C322

C170

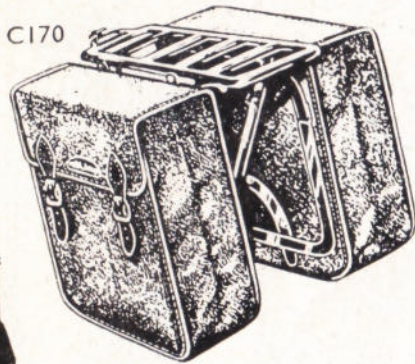

"BAG IT!" THE BARGAIN
OF THE
YEAR

C175



Size 9" x 7" x 5" 4/9

STANDS (Cycle)

- | | | |
|------|--|------|
| J300 | SHURESTA "XL" de-luxe model, twin folding legs, polished alloy ... | 15/6 |
| J301 | SHURESTA single leg, for 26" or 28" wheel, polished alloy ... | 8/9 |
| J302 | RALEIGH, single leg, for 26" and 28" wheel, polished alloy ... | 8/9 |

TENNIS RACKET CLIPS

- | | | |
|------|--|-----|
| B350 | TERRY, clips on front fork, black ... | 3/6 |
| B351 | TERRY, clips on front fork, silver ... | 4/- |

TOE CLIPS and STRAPS

- | | | |
|------|---|-----|
| D334 | SMITHS No. 17, chromium plated Pair | 3/- |
| D333 | BROOKS No. 1, adjustable, chromium plated ... | 5/6 |
| D212 | Toe straps, Brooks No. 1 chrome leather, adjustable, quick release Pair | 3/9 |
| D214 | Toe straps, Brooks No. 2, adjustable, quick release ... | 2/6 |

TROUSER CLIPS

- | | | |
|------|-------------------------------------|-----------|
| B222 | MANDAW, 1/2" wide, blued steel Pair | 6d. |
| B223 | Plastic covered steel ... | Pair 10d. |
| B226 | Celluloid covered steel ... | Pair 1/- |

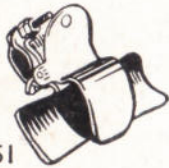
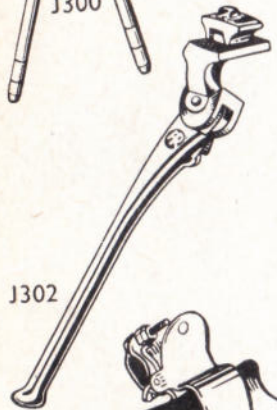
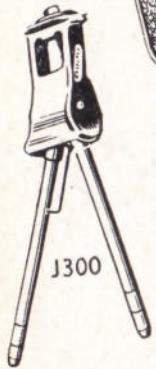

LARGE TOURING BAG
WITH SIDE POCKETS
RED PIPED

C172

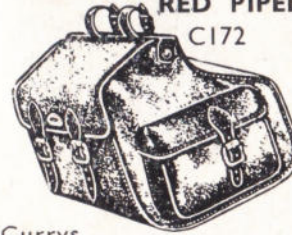

Currys
unbeatable value 14/9

TOURING BAGS

- | | | |
|------|--|-------------|
| C175 | Special quality, No. 295, Size 9" x 7" x 5", black, as featured ... | 4/9 |
| C152 | No. 535, 11" x 6" x 8", black leather cloth, red piping ... | 9/6 |
| C172 | Special quality, No. 250, 13" x 7 1/2" x 7 1/2", 2 side pockets, black with red piping ... | 14/9 |
| C173 | No. 251, tan, 2 pockets, 13" x 7 1/2" x 7 1/2" ... | 16/11 |
| C168 | No. 260, extra strong, 13" x 10" x 8", 2 side pockets, black with red piping ... | 22/6 |
| C157 | No. 300, Green leather cloth, green piping, 13" x 10" x 8", 2 side pockets ... | £1 8 6 |
| C181 | BROOKS "Glenbrook", 13" x 7" x 6 1/2", 2 side pockets ... | £1 5 6 |
| C183 | BROOKS "Leabrook", 13" x 7" x 6 1/2", 2 side pockets ... | £1 9 11 |
| C170 | PANNIER SET, Midland No. 4593, stay fitting carrier and 2 bags, 12" x 12" x 4" ... | £2 11 0 1/2 |

TOURING BAG SUPPORTS

- | | | |
|------|---|------|
| C112 | ASHBY No. 48, seat pillar fitting ... | 1/10 |
| C113 | BROOKS B2166, touring bag support, chrome ... | 5/9 |
| C116 | LLOYDS "Quickfit", clips on back stays, tubular frame ... | 4/9 |
| C114 | SMITHS No. 90, stay fitting, chromium plated ... | 3/- |

TOOL BAGS

- | | | |
|------|---|-----|
| C109 | ARROWSMITH No 1, black leather key fastening ... | 4/3 |
| C108 | ARROWSMITH Juvenile, black leather, key fastening ... | 3/9 |

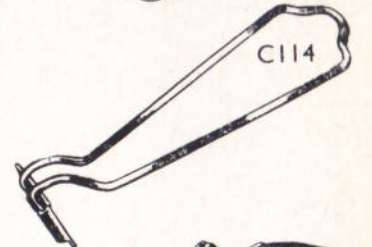
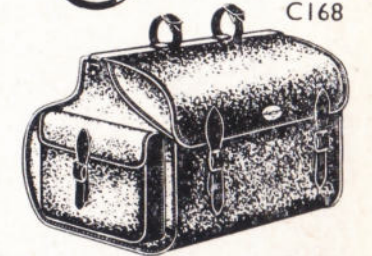
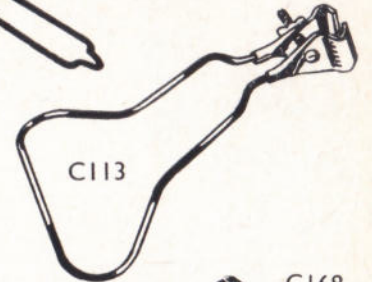
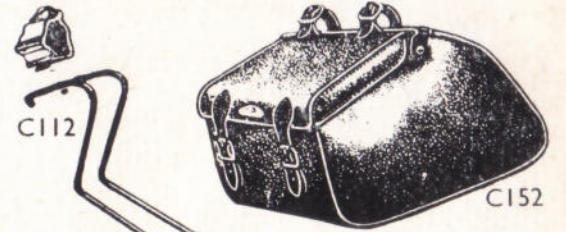
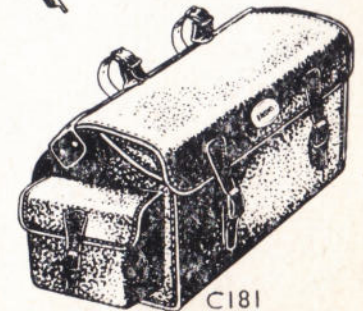
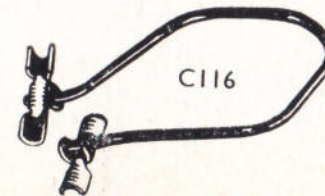

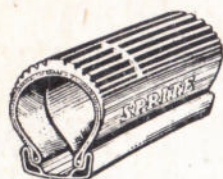

G314

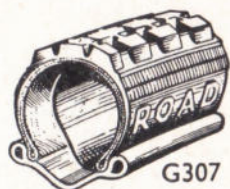

G307

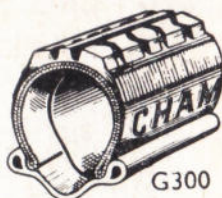

G300

TYRES, DUNLOP



G360

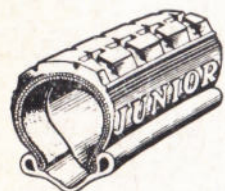

G322

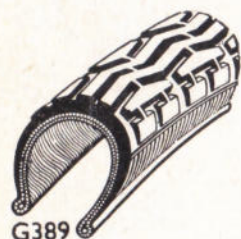

G389

TYRES, MICHELIN

- G300 CHAMPION, 26" x 1 1/4", 26" x 1 3/8",
26" x 1 1/2", 28" x 1 1/2" and 24" x 1 3/8" 11/9
- G307 ROADSTER, 26" x 1 1/4", 26" x 1 3/8",
26" x 1 1/2", 24" x 1 3/8" and 22" x 1 3/8" 14/-
- G314 SPRITE, 26" x 1 1/4", 26" x 1 3/8", 27" x 1 1/4" 16/2
- G330 SPEED, 26" x 1 1/4" and 26" x 1 3/8" 16/2
- G326 MOTORETTE, 26" x 1 3/8" 18/2
- G327 MOTORETTE, 26" x 1 3/4" x 1 1/2" £1 0 1
- G329 MOPED, 23" x 2" 24/-
- G360 HIGH PRESSURE ROAD RACING,
26" x 1 1/4" and 27" x 1 1/4" £1 0 1
- G322 JUNIOR, 14" x 1 3/8", 16" x 1 3/8", 18" x 1 3/8"
and 20" x 1 3/8" 9/4
- G332 TRICYCLE "Airsprung," 16" x 1 1/4" 17/-

- G389 ZIG-ZAG, 26" x 1 1/4", 26" x 1 3/8", 26" x 1 1/2"
and 28" x 1 1/2" 11/9
- G395/6 ROADSTER, 26" x 1 1/4" and 26" x 1 3/8" 14/-
- G393 "25" HIGH PRESSURE, 26" x 1 1/4" and
27" x 1 1/4" £1 0 1



H093

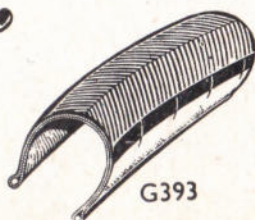

G393

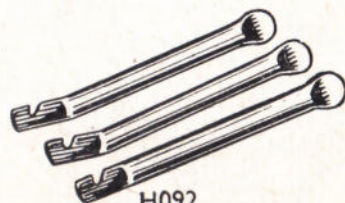

H092

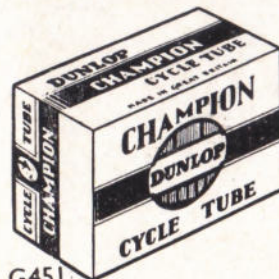

G451

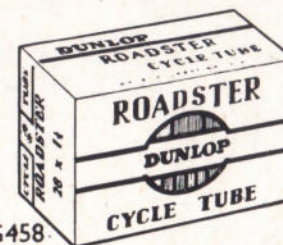

G458

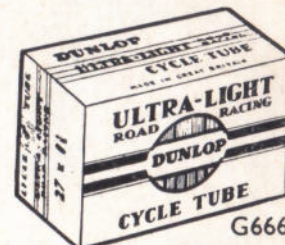

G666

TUBES, DUNLOP. Sizes same as for tyres

G451 CHAMPION	5/10
G458 ROADSTER	6/8
G465 SPRITE	6/3
G468 SPORTS, sizes as speed tyres	5/10
G666 HIGH PRESSURE	6/8
G671 TANDEM	6/8
G678 MOTORETTE	7/-
G679 MOPED, 23" x 2"	8/-
G477 MICHELIN TUBES. "Universal", sizes as for Zig-Zag tyres	5/10
G473 JUNIOR	5/1

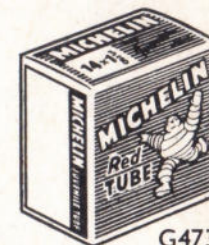

G473

TYRE LEVERS

H092 BROOKS No. 6. Set of 3, plated	...	Set	2/-
H091 ASHBY heavy No. 6. Set of 3	...	Set	8d.
H095 Round section levers, set of 3, cadmium plated	...	Set	11d.
H093 TERRY patent "No-Nip"	2/6

VALVE PARTS

J140 Valve Unit, complete	1/-
J141 Valve Body Cap	1d.
J142 Valve Plugs	3d.
J144 Valve Rim Nuts	1d.
J145 Valve Dust Caps	1d.
J153 DUNLOP. "Easy-Pump", valve insert	...	Pair	1/-
J220 SCHRADER valve cores, box of five	2/-
J221 SCHRADER valve caps, box of five	1/8

VALVE RUBBER

J146 DUNLOP, cut to length	...	Per Foot	3d.
J150 DUNLOP, packets of 5 pieces	2d.



J142



J145



J144



J141



J150



J153

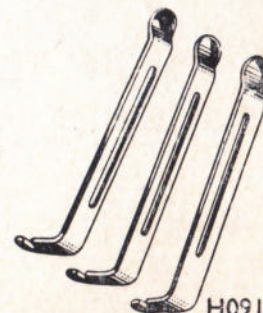

H091



K211



K193



K200



K199

GOGGLES

- K193 DWYER No. 12, one-piece celluloid 2/3
- K197 STADIUM No. 303, shaped, splinter-proof glass 9/6
- K199 STADIUM No. 333 "Vista", rubber mounted, one-piece 9/11
- K200 STADIUM No. 334 "Vista", Junior, rubber mounted, one-piece 7/6
- K195 STADIUM No. 366, rubber mounted and shaped 4/6
- K201 STADIUM. "VISTA" Senior, rain goggles 12/6
- K202 STADIUM. "VISTA" Junior, rain goggles 9/6
- K203 STADIUM, Mark X 8/6



K197

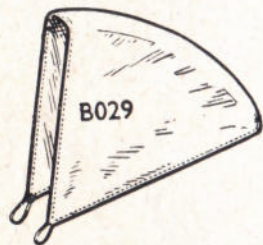

B029

HELMETS

- K211 No. 11, Mens, tan leather with ear flaps, lined, Size 7 18/11
- K217 Ski-Caps, Black leather, lined, Size 7 19/6
- K214 No. 11, Ladies, White, Size 7 19/11



K217

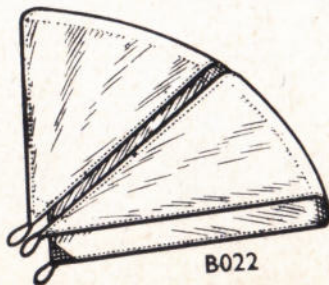

B022

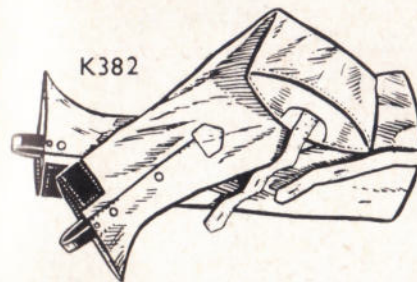

K382



K430

WATERPROOF CLOTHING — CAPES

- K151 Plastic, standard quality, welded seams, gold, 42" ... 15/6
- K153 Plastic, standard quality, welded seams, gold, 45" ... 18/6
- K152 "DUTTON" plasticised fabric, gold, 45" ... £1 8 11
- K146 "DUTTON" Oilskin capes, standard quality, 45", Black or Gold ... £1 4 11
- K144 "DUTTON" Oilskin capes, special quality, 42", Black or Gold ... £1 1 0
- K406 Single Texture Capes, 42", Fawn ... £1 6 11
- K419 Double Texture Capes, 42", Fawn ... £1 13 11
- K430 Cape and Hat sets, plastic, ladies, 42" Black, Pink, Green and Blue ... £1 1 0
- K382 Leggings, Oilskin, standard quality, 30", Black and Gold ... 15/11
- K418 Leggings, Double Texture, 30", Fawn ... £1 8 11
- K423 "DUTTON", plasticised fabric, 30", Gold with stud fastening gusset ... £1 1 0
- K173 Sou'westers, Oilskin, Black or Gold ... 4/6



K173

DRESS GUARDS (Plastic)

- B029 Front plastic, transparent or Black, Blue and Green ... 1/6
- B022 "PLY-VIC", rear fitting, white plasticised ... 3/11
- B023 ditto front fitting ... 2/11
- B051 Ply-vic, front fitting, black, plastic ... 2/11
- B052 Ply-vic, rear fitting, black, plastic ... 3/11
- K008 Gloves, tan leather, with wrist strap, Sizes 8, 9 and 10 ... 19/11



K008

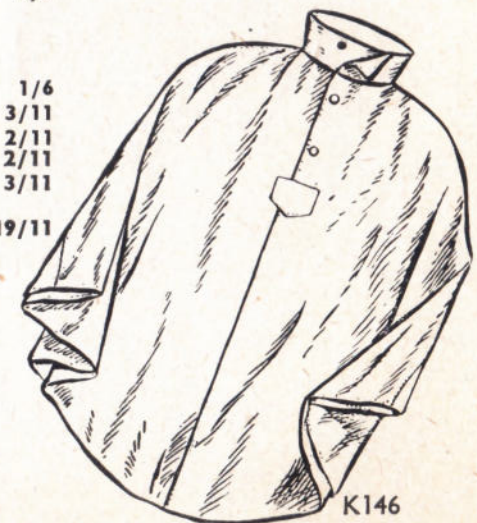

K146

OVER 265 BRANCHES AT YOUR SERVICE!

BRANCH ADDRESSES

- | | | | |
|---|-------------------|--|-----------------------|
| ABERGAVENTY : 2 High Street. | Tel. 730 | CHESTER : 20 Frodsham Street. | Tel. 22549 |
| ACCINGTON : 32 Blackburn Rd. | Tel. 4824 | CHESTERFIELD : 33 Burlington St. | Tel. 4246 |
| ALDRSHOT : 12-14 Union Street. | Tel. 230 | CHICHESTER : 65 South Street. | Tel. 3564 |
| ALFRETON : 3 High Street. | Tel. 512 | CHIPPENHAM : The Bridge. | Tel. 2263 |
| ALTON : 54 High Street. | Tel. 3813 | CIRENCESTER : 6E Cricklade Street | |
| ANDOVER : 16-18 High Street. | Tel. 3291 | & 38 Market Place. | Tel. 827 |
| ANDOVER : 84 High Street. | Tel. 2902 | COALVILLE : 9 Belvoir Road. | Tel. 630 |
| ARBROATH : 151-153 High Street. | Tel. 2516 | COLCHESTER : 45-46 High St. | Tel. 2489 |
| ASHFORD : 31 Bank Street. | Tel. 172 | CONGLETON : 25 High Street. | Tel. 147 |
| ASHTON-UNDER-LYNE :
237-239 Stamford Street. | Tel. 3826 | CORBY : 82 Rockingham Rd. | Tel. 3094 |
| AYLESBURY : 20a High Street. | Tel. 840 | COVENTRY : 1 Jordan Well. | Tel. 2246 |
| AYR : 8-10 High Street. | Tel. 6163 | CREWE : 26 Market Street. | Tel. 2575 |
| BANBURY : 19-20 High Street | Tel. 2749 | CROYDON : 82 Church Street. | Tel. 5619 |
| BANGOR : 300 High Street. | Tel. 1107 | DARLINGTON : 10 Skinnergate. | Tel. 4030 |
| BARNLEY : 13 Market Hill. | Tel. 5406 | DEAL : 56 High Street. | |
| BARNSTAPLE : 37 High St. & 31 Joy St. | Tel. 2308 | DERBY : 43 East Street. | Tel. 42560 |
| BASINGSTOKE : 9-11-13 London St. | Tel. 622 | DEVIZES : 29 The Brittox. | Tel. 696 |
| BATH : 6 & 7 Southgate Street. | Tel. 4819 | DEWSBURY : 17 Broadway House,
Foundry Street. | Tel. 1739 |
| BATH : 28 Westgate Street. | Tel. 4817 | DIDCOT : 166 The Broadway. | Tel. 3158 |
| BEDFORD : 67 High Street. | Tel. 3668 | DISS : 27 Mere Street. | Tel. 267 |
| BEDMINSTER : 139 East Street, Bristol 3. | Tel. Bristol 6372 | DONCASTER : 61 Hall Gate. | Tel. 2986 |
| BELPER : 49 King Street. | | DOVER : 44 Biggin Street. | Tel. 332 |
| BEVERLEY : 47 Toll Gavel. | Tel. 82357 | DRIFFIELD : 35 Market Place. | Tel. 2233 |
| BIRMINGHAM : 180-181 Broad Street. | Tel. Midland 4989 | DURHAM : 76 Saddler Street. | Tel. 4613 |
| BISHOP AUCKLAND : 107 Newgate Street. | Tel. 1069 | EASTBOURNE : 85 Seaside Rd. | Tel. 6742 |
| BISHOP'S STORTFORD : 13 Potter Street. | Tel. 588 | EASTLEIGH : 41 Market Street. | Tel. 2833 |
| BLETCHLEY : 152 Bletchley Road. | Tel. 162 | E. DEREHAM : 35 Market Place. | |
| BOGNOR REGIS : 1 Water Tower Buildings,
London Road. | Tel. 650 | EAST GRINSTEAD : 17 London Rd. | Tel. 3904 |
| BOSCOMBE : 644 Christchurch Rd. | Tel. 36867 | EDINBURGH : 105-109 Leith Street. | Tel. Waverley 3152 |
| BOSTON : 18-20 Strait Bargate. | Tel. 2637 | ELY : 15-17 High Street. | Tel. 2108 |
| BOURNE : 2 North Street. | Tel. 239 | EVESHAM : 44 Bridge Street. | Tel. 6111 |
| BRAINTREE : 42 Bank Street. | Tel. 1270 | EXETER : 230 High Street. | Tel. 74841 |
| BRIDGWATER : 28 Eastover. | Tel. 3334 | FAKENHAM : Norwich Road. | |
| BRIDLINGTON : 2 Prince St. | Tel. 4866 | FALMOUTH : 23/24 Market St. | Tel. 1194 |
| BRIDPORT : 16 East Street. | Tel. 2444 | FARNHAM (Surrey) : 119 West Street. | Tel. 6626 |
| BRIGG : Market Place. | Tel. 2259 | FAVERSHAM : 4-5 West Street. | Tel. 2610 |
| BRIGHTON : 25 York Place, London Road. | Tel. 28354 | FELIXSTOWE : 69 Hamilton Road. | Tel. 3718 |
| BRISTOL : 21 West Street. | Tel. 58897 | FOLKESTONE : 7 Rendezvous St. | Tel. 2739 |
| BRISTOL : 26-28 Lower Castle St. | Tel. 21776 | FROME : 1 Stony Street. | Tel. 2625 |
| BRISTOL : 216-218 Cheltenham Rd. | Tel. 43495 | GAINSBOROUGH : 9 Market St. | Tel. 2625 |
| BURTON-ON-TRENT : 178 Station Street. | Tel. 2231 | GILLINGHAM (Kent) : 110 High Street. | Tel. 59937 |
| BURY ST. EDMUNDS : 22 Buttermarket. | Tel. 516 | GLASGOW : 2-4 St. George's Road,
Charing X. | Tel. Douglas 1534 |
| BUXTON : 70-72 Spring Gardens. | Tel. 444 | GLASTONBURY : 11 High Street. | Tel. 359 |
| CAMBORNE : 32-34 Commercial Street.
(Cornwall) | Tel. 2369 | GLOSSOP : 15 High St. West. | Tel. 322 |
| CAMBRIDGE : 38 Regent St. | Tel. 54700 | GLOUCESTER : 12 Eastgate St. | Tel. 21103 |
| CANTERBURY : 12 High Street. | Tel. 3040 | GODALMING (Surrey) : 36a High St. | Tel. 48 |
| CARLISLE : 63 Scotch Street. | Tel. 22632 | GOOLE : 50 Boothferry Road. | Tel. 404 |
| CARMARTHEN : Lyric Buildings,
King Street. | Tel. 6032 | GRANTHAM : 52 High Street. | Tel. 79 |
| CHATHAM : 286 High Street. | Tel. 4275 | GRAVESEND : 27-28 New Rd. | Tel. 1803 |
| CHELMSFORD : 62 High Street. | Tel. 3976 | GRIMSBY : 62/64 Freeman St. | Tel. 3476 |
| CHELTENHAM : 253 High Street. | Tel. 53725 | GUILDFORD : 16 Swan Lane. | Tel. 4199 |
| CHELTENHAM : 127 High Street. | Tel. 55217 | HALSTEAD : 66 High Street. | |
| | | HARROGATE : 33 Beulah Street. | Tel. 6102 |
| | | HARROW : 26 St. Ann's Road. | Tel. 0664 |
| | | HASTINGS : 29 Queen's Road. | Tel. 1618 |
| | | HAYWARDS HEATH : 84 South Rd. | Tel. 406 |
| | | HEANOR : 37 Market Street. | Tel. Langley Mill 987 |

WHEELS, RIMS and RIM TAPES
WHEELS. All chromium plated

- | | |
|---|---------|
| G171 Front, with Westwood rims, sizes 24" x 1 1/4",
26" x 1 1/2", 26" x 1 1/2", 28" x 1 1/2" ... | 19/3 |
| ditto with dyno-hub ... | £3 11 9 |
| G185 Front with Endrick rims, racing hub, 26" x 1 1/4",
26" x 1 1/2" ... | £1 0 9 |
| ditto with dyno-hub ... | £3 11 9 |
| G195 Rear with Westwood rims, sizes as front. | £1 1 9 |
| ditto with Sturmey-Archer 3-speed A.W. | £3 2 6 |
| ditto with Sturmey-Archer Dyno-3 hub | £5 8 4 |
| G210 Rear with Endrick rims, sizes as front. | £1 3 0 |
| ditto with Sturmey-Archer 3-speed A.W. | £3 2 6 |
| ditto with Sturmey-Archer Dyno-3 hub | £5 8 4 |
| Full range of Sturmey-Archer 3- and 4-speed
wheels, close or medium ratio, also available | |

RIMS. Chrome plated

- | | |
|--|------|
| G070 Westwood rims, front or rear, sizes, 26" x 1 1/4",
26" x 1 1/2", 28" x 1 1/2" and 24" x 1 1/2" ... | 10/6 |
| G080 Endrick rims, front or rear, sizes, 26" x 1 1/4",
26" x 1 1/2" ... | 10/6 |

RIM TAPES

- | | |
|-------------------------|-----|
| G090 CURRY, cotton ... | 5d. |
| G091 DUNLOP, rubber ... | 1/- |

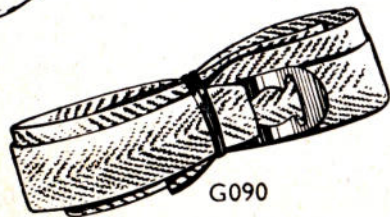
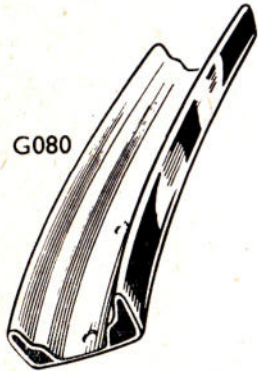
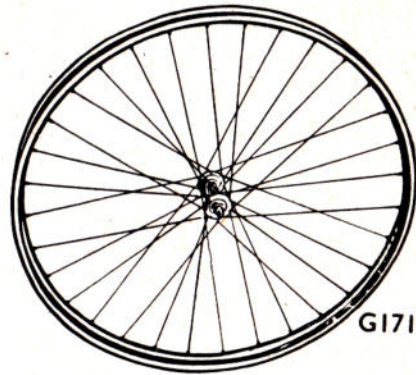

BRANCH ADDRESSES — continued

HEREFORD : 10 High Town. Tel. 2559
 HERNE BAY : 139 Mortimer St. Tel. 1195
 HERTFORD : 33-35 Fore Street. Tel. 2168
 HIGH WYCOMBE : 6 Oxford St. Tel. 1197
 HITCHIN : 19 Market Place. Tel. 2054
 HOLBEACH : West End. Tel. 2200
 HORNCASTLE : 6 High Street. Tel. 3279
 HORSHAM : 30 West Street. Tel. 2929
 HOVE : 83 George Street. Tel. 33542
 HULL : 15 King Edward St. Tel. 15978
 HUNTINGDON : 128 High Street. Tel. 440

ILKESTON : 66 Bath Street. Tel. 730
 IPSWICH : 34-34a Carr Street. Tel. 4158

KEIGHLEY : 80-82 Low Street. Tel. 4483
 KENDAL : 52 Highgate Tel. 1449
 KETTERING : 41-43 High Street. Tel. 2247
 KIDDERMINSTER : 7 Swan St. Tel. 4106
 KING'S LYNN : 82 High Street. Tel. 2481

LANCASTER : 62-64 Penny St. Tel. 5085
 LAUNCESTON : 9 High Street. Tel. 519
 LEAMINGTON : 11 Bath Street. Tel. 7207
 LEEDS : 80 Vicar Lane, Tel. 24298
 LEEK : 8 Derby Street. Tel. 498
 LEICESTER : 15 Haymarket. Tel. 58625
 LEOMINSTER : 12 High Street. Tel. 2393
 LEWES : 47 Cliffe High St. Tel. 1691
 LINCOLN : 304 High Bridge. Tel. 1488
 LITTLEHAMPTON : 57 High St. Tel. 88
 LIVERPOOL : 12/18 Parker Street. Tel. Royal 1991

LONG Eaton : 49 High Street. Tel. 294
 LOUGHBOROUGH : 7 Swan St. Tel. 3862
 LOUTH : 92 East Gate. Tel. 464
 LOWESTOFT : 59 London Rd. North Tel. 516
 LUDLOW : 3 The Bull Ring. Tel. 634
 LUTON : 1 Park Street. Tel. 648

MAIDENHEAD : 7-9 Market St. Tel. 1612
 MAIDSTONE : 39 High Street. Tel. 3307
 MAIDSTONE : 125-127 Week St. Tel. 2528
 MALTON (Yorks.): 19 Wheelgate. Tel. 568
 MARCH : 7-9 Broad Street. Tel. 3006
 MKT. HARBOROUGH : 5 High Street. (Leics.) Tel. 2017

MELKSHAM : 20 Bath Road. Tel. 3414
 MELTON MOWBRAY : 4 Cheapside. Tel. 695
 MIDDLESBROUGH : 96 Linthorpe Road. Tel. 43353
 MONMOUTH : 14 Agincourt Square. Tel. 520

NELSON : 38 Scotland Road. Tel. 2177
 NEWARK : 12-13 Market Place. Tel. 589
 NEWBURY : 38 Northbrook St. Tel. 324
 NEWMARKET : The Chestnuts, 14 High St. Tel. 2027

NEWPORT (I o W.): 53 High St. Tel. 2858
 NEWPORT (Mon.): 54 Commercial Street. Tel. 66148

NEWTON ABBOT : 54 Queen St. Tel. 1215
 NORTHAMPTON : 57 Abington St. Tel. 1499
 NORTHAMPTON : 27 Gold St. Tel. 2133
 NORTH HARROW : 14a Broadwalk. Tel. Pinner 8379

NORTH WALSHAM : 7 Market Place. Tel. 2268

NORTHWICH : 23-25 Witton St. Tel. 2616
 NORWICH : 18 Prince of Wales Road. Tel. 25935

NOTTINGHAM : 6 Carlton St. Tel. 41648
 NUNEATON : 128 Abbey St. Tel. 2428

OSWESTRY : 13 Church Street. Tel. 779
 OXFORD : 30 Queen Street. Tel. 2853
 OXFORD : 92 Cowley Road. Tel. 47177

PARKSTONE (Dorset) : 366 Ashley Road. Tel. 1281

PENRITH (Cumb.): 3 Middlegate. Tel. 2940
 PENZANCE : 2 Alverton Street. Tel. 2564
 PENZANCE : 13 Market Jew Street.
 PETERBOROUGH : Municipal Buildings, Bridge Street. Tel. 2929

PETERSFIELD : 13 Chapel Street. Tel. 610
 PINNER (Middx.) : 49 Bridge Street. Tel. Pinner 8329

PLYMOUTH : 131-133 Armada Way. Tel. 61884

POOLE : 165 High Street. Tel. 544
 PORTSMOUTH : 48 London Rd., North End. Tel. 74372

PORTSMOUTH : 118-120 Kingston Road, (Near "The Shaftesbury"). Tel. 5914
 PORTSMOUTH : 217 Commercial Rd. Tel. 73650

PORT TALBOT : 87 Station Road.
 PRESTON : 5 Friargate. Tel. 56992

RAMSGATE : 39 High Street. Tel. Thanet 53360

READING : 4-5 West Street. Tel. 54364
 REDCAR : 36 High Street. Tel. 1386
 REDDITCH : 6 Market Place. Tel. 1098
 REDHILL : 3 High Street. Tel. 2995
 REDRUTH : 71 Fore Street. Tel. 88
 RETFORD : 30 Market Place & 31 The Square. Tel. 2102

RICHMOND (Surrey) : 17 Hill St. Tel. 6811
 RIPLEY : Oxford Street. Tel. 729
 RIPON : 82 North Street. Tel. 419

ROCHDALE : 95 Yorkshire St. Tel. 49184
 ROSS-ON-WYDE : 6 & 7 Broad St. Tel. 2796
 RUGBY : 20 Sheep Street. Tel. 2879
 RUSHDEN : 87 High Street. Tel. 3401
 RYDE (I o W.): 169 High St. Tel. 2477

SALISBURY : 27 Butcher Row. Tel. 3810
 SCARBOROUGH : 66 Newborough. Tel. 4414
 SCUNTHORPE : 43 High Street. Tel. 3840
 SELBY : 13-15 Gowthorpe. Tel. 731

SEVENOAKS : 143 High Street. Tel. 4134
 SHEERNESS : 34-36 High Street. Tel. 2085
 SHIRLEY (S'ampton) : 3 Gordon Buildings, High Street. Tel. Southampton 71177

SHREWSBURY : 61 Mardol. Tel. 5156
 SITTINGBOURNE : 30 High St. Tel. 1001
 SKEGNESS : 54-56 Lumley Road. Tel. 1248
 SLEAFORD : 7 Southgate. Tel. 186
 SLEAFORD : 19 Southgate. Tel. 62

SOUTHAMPTON : 10-11 Bargate Tel. 22333
 SOUTHAMPTON : 50-51 East St. Tel. 22467
 SOUTHEND-ON-SEA : 32 Southchurch Road. Tel. 68850

SPALDING : 14 Market Place. Tel. 2525
 STAINES : 106 High Street. Tel. 252
 STAFFORD : 20 Greengate. Tel. 973
 STAMFORD : 72 High Street. Tel. 3366
 STOCKTON-ON-TEES : 107 High Street. Tel. 66896

STRATFORD-on-AVON : Central Chambers, Henley St. & 38 High St. Tel. 2265
 STROUD : 14 High Street. Tel. 939
 SWADLINCOTE : 13 High Street. Tel. 7839
 SWANSEA : 258 Oxford Street. Tel. 3707
 SWINDON : 33-34 Bridge St. Tel. 2345
 SUTTON-IN-ASHFIELD : Market St. Tel. 224

BRANCH ADDRESSES — continued

TAUNTON : 2 East Street. Tel. 2798
 TEIGNMOUTH : 1 Bank Street. Tel. 946
 THETFORD : King Street. Tel. 3120
 TIVERTON (Devon) : 36 Fore Street. Tel. 2803

TONBRIDGE : 80 High St. Tel. 3788
 TORQUAY : 49 Union Street. Tel. 7096
 TOTNES : 55 High Street. Tel. 3044
 TOTTENHAM : 488 High Rd, N.17. Tel. 1959
 TROWBRIDGE (Wilts.) : 55 Fore Street. Tel. 3304

TRURO : 28 Boscawen Street. Tel. 3588
 TUNBRIDGE WELLS : 21 Calverley Road. Tel. 2173

UXBRIDGE : 198 High Street. Tel. 4666

WALTHAMSTOW : 24 High Street, E.17. Tel. Larkwood 4184

WARMINSTER : 35 Market Place. Tel. 3043
 WARRINGTON : 110 Bridge St. Tel. 1628
 WATFORD : 142 High Street. Tel. 3689
 WELLINGBOROUGH : 15 Silver St. Tel. 2757
 WELLINGTON (Salop) : 55 New Street. Tel. 410

WELLINGTON (Som.) : 7 Fore St. Tel. 534
 WELLS : 53 High Street. Tel. 2052
 WEMBLEY : 480 High Road. Tel. 3340

WESTON-SUPER-MARE : 72 High Street. Tel. 1782
 WHITCHURCH (Salop) : 14 High Street. Tel. 618

WIMBORNE : 31 High Street. Tel. 150
 WINCHESTER : 144 High Street. Tel. 3166
 WINDSOR : 37 Peascod Street. Tel. 1136
 WINTON (Bournemouth) : 382 Wimborne Rd. Tel. 219

WINTON (Bournemouth) : 410 Wimborne Road. Tel. 1115
 WISBECH : 18 High Street. Tel. 357
 WISBECH : 111-112 Norfolk St. Tel. 1584
 WITNEY : 30 High Street. Tel. 563
 WOKING : 16 High Street. Tel. 1786
 WOLVERHAMPTON : 42 Queen Square. Tel. 22809

WOODBRIDGE : 4a Thoroughfare. Tel. 454
 WORCESTER : 9 Broad Street. Tel. 3589
 WORKINGTON (Cumberland) : 15 Pow St. Tel. 1030

WORKSOP : 37 Bridge Place. Tel. 2792
 WORTHING : 6 Warwick St. Tel. 5123
 WREXHAM : 40 Hope Street. Tel. 2463

GT. YARMOUTH : 114a Regent Rd. Tel. 3797

YORK : 12 The Pavement. Tel. 23138
 YEOVIL : 22 Middle Street. Tel. 173

PHILLIPS
Gadabout

PETROL
 CONSUMPTION
 180 m.p.g.

From the stable of one of the largest cycle factories in the world comes this entirely new powerful Phillips Moped. With the very latest 49 c.c. Continental engine, self-sprung front forks, built-in lighting, electric horn and a pressed-steel frame of exceptional strength, it is right in the front of the Moped market. Other deluxe features include prop stand and luggage carrier, luxury sprung saddle. Finish in polychromatic red enamel, the Phillips "Gadabout" is a real winner.

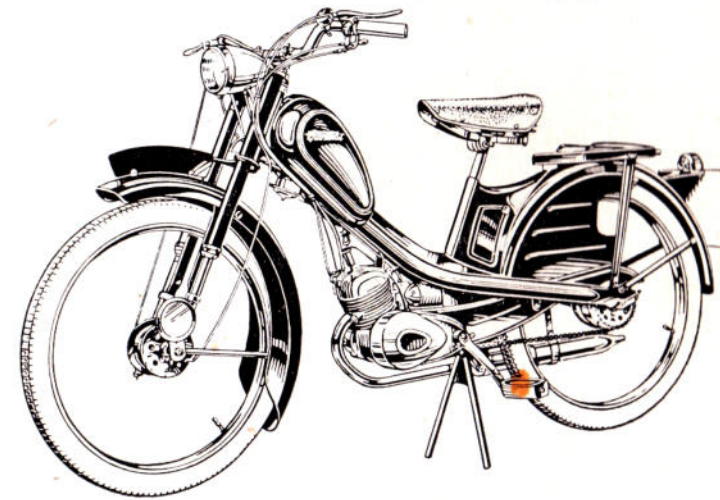

68 gns.

OR ON EASY TERMS

FROM YOUR LOCAL BRANCH OF

Currys
LTD.